

MASTER HUGO GERNSBACK, Editor-in-Chief 1966 JAN. 50c

Radio-Electronics

TELEVISION • SERVICING • HIGH FIDELITY

A
GERNSBACK
PUBLICATION

SPECIAL COLOR-TV ISSUE

**HOW YOU
SEE
COLOR**

Turn to page 34



SERVICING
Special chart spots
TV color troubles

BUILD
Low-cost video
modulator!

1966 DIRECTORY

CHARLES WATTS 10-67
8595 WELLS RD
CINCINNATI OHIO 45242

PICK ANY NUMBER FROM 1G3GT TO 19AU4 AND YOU'RE A WINNER!

1G3GT/1B3GT	4HA5	6BZ6	6GW8	8CW5
1X2B	5HG8	6CB6A	6HA5	9A8
3BZ6	5U8	6CG7	6HG8	10CW5
3CB6	6AL5	6DT6	6S4A	12AT7
3GK5	6AU4GTA	6EH7	6SN7GTB	12AU7A
3HA5	6AU6A	6EJ7	6U8A	12AX4GTB
4BL8	6AV6	6GB5	6U9	12AX7A
4EH7	6AX4GTB	6GJ7	6X9	15CW5
4EJ7	6BA6	6GK5	6Y9	16AG
4GK5	6BL8	6GK6	8BQ5	19AU4

...AND ON AND ON. FOR THE COMPLETE LIST, WRITE
AMPEREX ELECTRONIC CORPORATION, HICKSVILLE, L.I., NEW YORK 11802.

Circle 1 on reader's service card



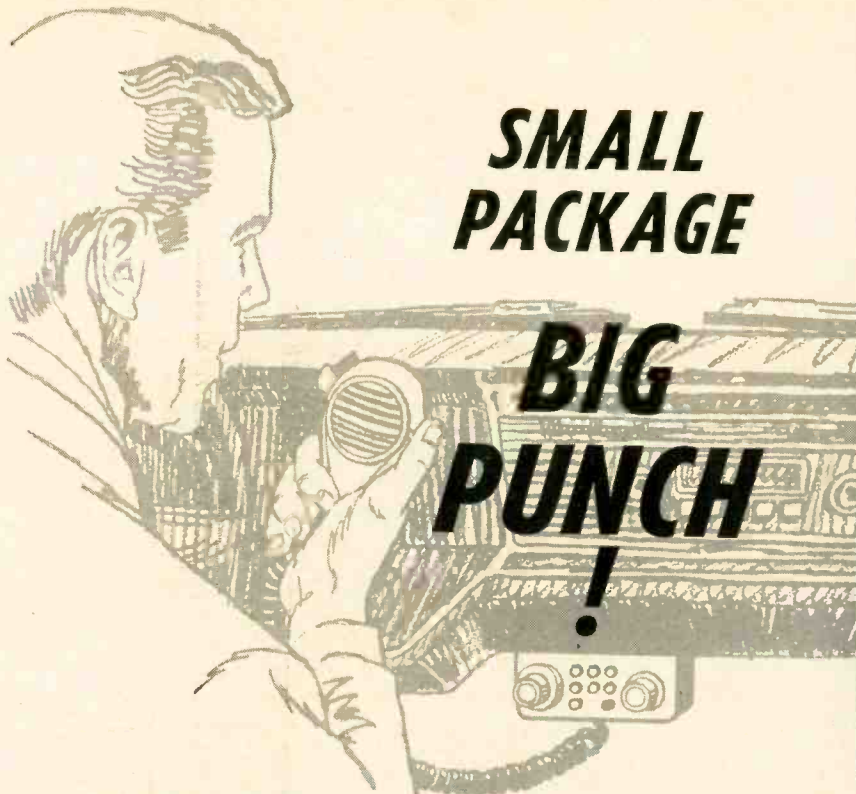

**SMALL
PACKAGE**

**BIG
PUNCH
!**

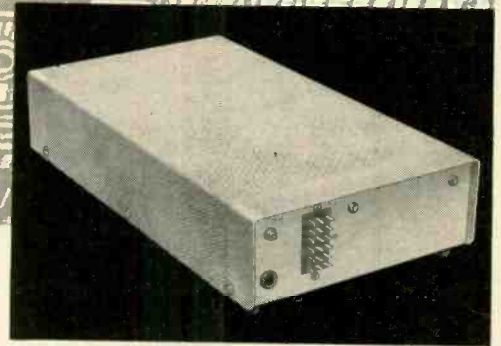
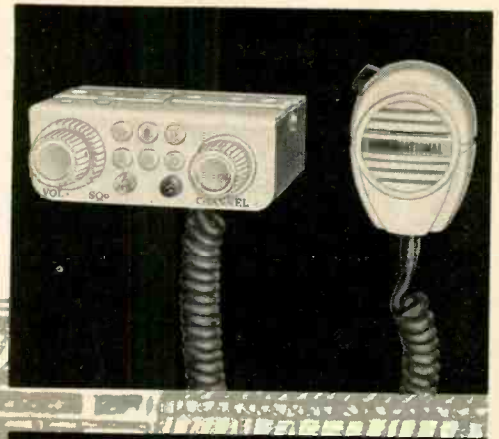

**INTERNATIONAL Model MO TRANSCEIVER
For CITIZENS RADIO SERVICE**

- New Compact Size
- New Solid-State Crystal Switching Circuit
- New Photo-Control Volume Circuit
- New Remote Control With Matching Microphone



The International Model MO Citizens Radio transceiver, custom designed for mobile installation, provides instant push-to-talk crystal controlled operation on any 6 channels with full 5 watts power input. The new compact control head provides complete remote controlled operation. All circuits are dc using solid-state crystal switching. The operating channel is indicated by an illuminated button on the control head. Tubes and silicon transistors are combined to provide a rugged trouble-free circuit.

The complete transceiver includes: a remote control head (about the size of a cigarette package), matching white microphone, new compact transmitting / receiving unit which may be conveniently installed in the trunk, and a matching white speaker which mounts under the dash. Operates from 12 vdc negative ground power source. Other power input units are available on special order.

See the "all new" International Model MO at your dealer today.

FCC Citizens Radio license required. All use must conform with Part 95, FCC Rules and Regulations.



CRYSTAL MFG. CO., INC.

18 NO. LEE • OKLA. CITY, OKLA. 73102

Circle 2 on reader's service card

Get on the green.



Get with the new PRECISE Green line for truly new design and decor in test instruments. These unique units have color dynamic front panels featuring easy-on-the-eyes Green to aid readability and accuracy. New functional design and layout make operation fast and foolproof. Inside, they're on line with sophisticated circuitry checked out for reliability. So when it comes to test instruments, take the best course. Swing with PRECISE scopes, VTVMs, power supplies, signal generators, tube testers, decade boxes and probes.

MODEL 636

AF SINE SQUARE GENERATOR — 20 cps to 200 kc in four ranges. Less than 0.25% sine wave distortion at 10 vrms into 600 ohms load.

MODEL 780

CONTINUOUSLY VARIABLE REGULATED VOLTAGE SUPPLY — Regulated dc output from 0 to +400 v at 150 ma, and 0 to -150 v bias. Also provides unregulated ac. Meters for voltage and current.

MODEL 905

VACUUM TUBE VOLTMETER — Comes with assembled dc/ac-ohms probe. Direct reading of p-p voltages. Separate ac low voltage scale. Low 0.5 vdc range for transistor circuit measurements.



PRECISE ELECTRONICS / Division of Designatronics, Inc. / Mineola, L. I., N.Y.

Circle 3 on reader's service card

Radio-Electronics

JANUARY 1966 VOL. XXXVII No. 1

Over 55 Years of Electronic Publishing

GUEST EDITORIAL

- 33 Color Television 1965-1975.....*David Lachenbruch*

COLOR TELEVISION

- COVER STORY**
- 34 **How We See Color**.....*Eric Leslie*
Inside the color TV tube
- 36 **Chroma Trouble Chart**.....*Jack Darr*
Step-by-step checks help you pounce on color troubles
- 38 **How To Get Better Color**.....*Matthew Mandl*
Set the front panel controls right before you worry about service!
- 40 **Whatever Became of the Chromatron?**.....*Peter E. Sutheim*
Tube is appearing in sets in Japan
- 42 **Roundup of 1966 Color Receivers**
Chief features of all the new models
- 46 **Convergence in Basic English**.....*Jack Darr*
Ingenious circuitry boiled down to simple terms and diagrams
- 52 **Build a Video Modulator for CCTV**.....*Earl T. Hansen*
Works with any camera and home sets on channels 2 through 13
- 59 **Which Generator for Color Service?**.....*Robert A. Dunn and Don D. Herzog*
Rainbow, keyed rainbow or NTSC type?

GENERAL

- 22 Service Clinic
- 49 In-the-Ear Hearing Aid Uses Microcircuit
- 58 What's Your EQ?

AUDIO-HIGH FIDELITY-STEREO

- 50 **Repairing Record Changers**.....*Homer L. Davidson*
Second of two parts: what to do when it runs too slow
- 55 **Long Ones, Short Ones, Fat Ones, Tall Ones**.....*George L. Augspurger*
Bass-reflex enclosures don't have to be huge
- 67 **Equipment Report: AR-2a^x Speaker System; Garrard Lab 80 Automatic Turntable**

RADIO

- 45 **Improvement for Heathkit Multiplex Tuner**
- 54 **Selective AF Amplifier Boosts Receiver Performance**.....*I. Queen*
- 82 **The Phantom Resistor**.....*Wayne Lemons*
Cy and Lucky dig into a hybrid car radio

ELECTRONICS

- 39 **Electronic Nose Smells Gas**.....*Eric Leslie*

TEST INSTRUMENTS

- 56 **Quick Henry!**.....*Fred Blechman*
Measures inductance, resonance and Q
- 66 **Equipment Report: RCA WR-64B Color-Bar/Dot/Crosshatch Generator; Sencore CG135 All-Transistor Deluxe Color-Bar Generator**
- 88 **TV Pix on Scope Screen Pretty Common**

THE DEPARTMENTS

- 14 Correspondence
- 103 New Books
- 83 New Literature

- 75 New Products
- 84 New Semiconductors & Tubes
- 4 News Briefs

- 100 Noteworthy Circuits
- 98 Technotes
- 95 Try This One
- 58 50 Years Ago

72 Reader's Service Page

Cover illustration by Otto Markevics; photograph by Harry Schlack
Color tube components were supplied by courtesy of RCA Electronic Components and Devices Div.

HUGO GERNSBACK, *editor-in chief and publisher*. M. HARVEY GERNSBACK, *editor*. Fred Shunaman, *managing editor*. Robert F. Scott, W2PWG, *technical editor*. Peter E. Sutheim, *associate editor*. Jack Darr, *service editor*. I. Queen, *editorial associate*. Wm. Lyon McLaughlin, *technical illustration director*.

RADIO-ELECTRONICS, January 1966, Volume XXXVII, No. 1. Published monthly by Gernsback Publications, Inc. at Ferry Street, Concord, N. H. 03302. Second-class postage paid at Concord, N. H. Printed in U.S.A. One-year subscription rate: U. S. and possessions, Canada, \$5. Pan-American countries, \$6. Other countries, \$6.50. Single copies: 50¢. © 1966, by Gernsback Publications, Inc. All rights reserved. POSTMASTERS: Send Form 3579 to 154 W. 14th St., New York 10011.



Member,
Institute of High Fidelity
Radio-Electronics
is indexed in
Applied Science
& Technology Index
(Formerly
Industrial Arts Index).

NEWS BRIEFS

DU MONT DEAD AT 64 ✓

Cathode-ray tube and television pioneer Allen B. Du Mont died Nov. 15, 1965. His interest in electronics dated from age 11, when his father gave him a crystal set while he was recovering from a polio attack. He got a radio-telegraph license at age 15, and operated aboard ship for the next seven summers.

After graduating from Rensselaer Polytechnic Institute in 1924, he worked as tube production engineer for Westinghouse for 4 years, leav-



ing to become chief engineer for de Forest, who was manufacturing vacuum tubes and spinning-disc TV sets.

Du Mont left to set up his own business in 1931. Working in a garage, he improved the cathode-ray tube (until then an expensive imported laboratory curiosity with a life of a few hours) to a point where C-R oscilloscopes became practical, and became a large manufacturer of scopes.

Selling one of his best-known inventions, the electron-ray indicator, or Magic-Eye tube, to RCA, he used the proceeds to start a TV factory in Passaic, selling the first TV sets to the public a few days before RCA reached the market. Du Mont also established TV stations WABD (now WNEW-TV) in New York City, WTTG in Washington and WDTV (now KDKA) in Pittsburgh.

EUROPE ON THE BROADCAST BAND AGAIN

Once again this winter many European broadcast band stations are being heard in the Eastern part of the United States.

Most continental stations go off the air for the night at 6 pm (EST) and return between 12 midnight and 1 am. Most British stations go off at 6:45 pm and return between 12:30 and 1:30 am.

Best time for reception in December and January is from shortly after sunset till 6 or 7 pm and from midnight to 2:30 am EST.

Stations heard the past fall include Madrid 584 kc; BBC (England) 647 kc (this station also broadcasts in Russian from 10:45 to 11:15 pm); Seville 683 kc; Holland 746 kc; Miramar, Portugal 782 kc (till 7:30 pm); Nancy, France 836 kc; Rome 845 kc (24-hour schedule); London 908 kc; Holland 1007 kc; Droitwich, England 1088 kc; Czechoslovakia 1097 kc; Bordeaux 1205 kc; BBC 1214 kc (12:30 am-9 pm); BBC 1295 kc (foreign languages 11 pm-1 am; English 5 to 6 pm); Monte Carlo 1466 kc (midnight-6 pm).

Careful tuning and a very selective receiver are necessary.

BELL HAS HI-FI COMPUTER

The sounds of a trumpet have been generated by a computer at Bell Telephone Labs with such fidelity that they are indistinguishable from those of a real trumpet. The feat was accomplished by a 27-year-old French physicist, Jean Claude Risset, through a special computer program devised by Max Mathews and Joan E. Miller of Bell Labs.

Computer music has imitated the sounds of actual instruments before, and one piece, arranged by Dr. Mathews, has even produced a fair

imitation of the human voice. The present experiment, however, has approached the actual instrument far more closely than anything that was done in the past, and provides acoustic researchers with a fresh understanding of the features in a sound wave that give an instrument or the human voice its natural, distinctive quality.

TV RECORDER INTRODUCES NEW TAPE TRANSPORT IDEA

An interesting byproduct of the competition for low-priced TV tape recorders is a greatly improved tape transport, introduced by Par, Ltd., of Clifton, N. J. This transport consists of a short, endless plastic belt that moves continuously past the head. The tape is cradled in this belt and is held against the head in a way that eliminates any imperfections due to mechanical motion of the tape, prevents tape tension and stretching, and permits the use of thinner tapes than previously possible, according to Par's technical director, Stewart Hegeman.

With the new tape transport the machine produced excellent pictures, marred to some extent, however, by horizontal low-frequency noise lines, which Hegeman states will shortly be eliminated by a line-clamping technique similar to that of dc restoration in TV receivers.

ULTRASONICS SMOOTHS WIRE

Wire with a very smooth surface has been produced at Bell Telephone Laboratories by drawing it through dies submerged in an ultrasonically agi-

LASER LOGS LUNAR LINEARITY

Magnified view of aluminum surface used by Bell scientists in determining statistical values for irregularities on moon's surface. They determined average length, height and slope of lunar irregularities by bouncing laser beams off prepared surfaces like this one in the laboratory, and comparing with the way microwaves are backscattered from the moon. Area shown here is .0325 by .025 in.



ELECTRONICS

WHERE CAN YOU EQUAL THIS OPPORTUNITY

TO EARN A GOOD PAYING JOB IN A FAST GROWING FIELD?

DeVRY'S "BIG 3" AIDS TO PROGRESS ARE DESIGNED TO SPEED YOU QUICKLY TO A REAL FUTURE IN ELECTRONICS

- 1. EFFECTIVE TRAINING!**
Learn AT HOME in spare time, or day or evening in one of our RESIDENT SCHOOLS.
- 2. INDUSTRY RECOGNITION!**
DeVry programs, prepared with industry's help, are "JOB-AIMED."
- 3. EMPLOYMENT SERVICE!**
for ALL graduates through our contacts with many large, respected companies across North America.

ELECTRONICS is one field that spells OPPORTUNITY in big capital letters for many men 18 to 45. This widespread but FAST GROWING field offers trained men some of today's finest, good-paying job opportunities — or a chance to start a profitable servicing shop!

Even if you don't have previous technical experience or an advanced education, DeVry's "BIG 3" aids to progress may very well be YOUR stepping stones to a BETTER FUTURE. You can learn at home in your spare time, while keeping your present job. Or, in a day or evening program in our U.S. or Canadian resident school, you can develop the very skills needed to make wonderful progress. We even work to get resident students part-time jobs to help with tuition or living expenses, if necessary!

Regardless of how you complete your educational program with DeVry, you can count on industry-recognized, effective training aimed directly at providing on-the-job-type "know-how." This is followed by actual EMPLOYMENT SERVICE to help you get started in Electronics. Or, if you are in the field already, remember that a DeVry recommendation has meant plenty of ADDED DOLLARS in income to many who made themselves more valuable to employers.

See for yourself how you, too, may prepare for the INCOME, the PRESTIGE and the FINE FUTURE that goes with the title of Electronics Technician. Mail the coupon NOW for facts without obligation.

WE PREPARE YOU NOT FOR ONE JOB BUT FOR JOBS IN MANY DIVISIONS OF THE FASCINATING FIELD OF ELECTRONICS



MOVIES, TEXTS AND EQUIPMENT HELP YOU LEARN FASTER



DeVry includes training movies AT HOME, "programmed" texts and many shipments of Electronic parts — to help you learn quickly, remember more.

FREE

Send coupon for these two factual booklets NOW!



MAIL COUPON TODAY!

DeVRY TECHNICAL INSTITUTE
4141 Belmont Avenue, Chicago, Ill. 60641 Dept. RE-1-W

Please give me your two free booklets, "Pocket Guide to Real Earnings," and "Electronics in Space Travel"; also include details on how to prepare for a career in Electronics. I am interested in the following opportunity fields (check one or more):

<input type="checkbox"/> Space & Missile Electronics	<input type="checkbox"/> Communications
<input type="checkbox"/> Television and Radio	<input type="checkbox"/> Computers
<input type="checkbox"/> Microwaves	<input type="checkbox"/> Broadcasting
<input type="checkbox"/> Radar	<input type="checkbox"/> Industrial Electronics
<input type="checkbox"/> Automation Electronics	<input type="checkbox"/> Electronic Control

Name _____ Age _____
 Address _____ Apt. _____
 City _____ State _____ Zip _____
 Code _____

Check here if you are under 16 years of age.
HOME STUDY AND RESIDENT SCHOOL TRAINING
 AVAILABLE IN CANADA

DeVry Technical Institute

4141 Belmont Avenue
Chicago, Illinois 60641

Accredited Member of National Home Study Council

COMPLETE TUNER OVERHAUL

ALL MAKES — ONE PRICE

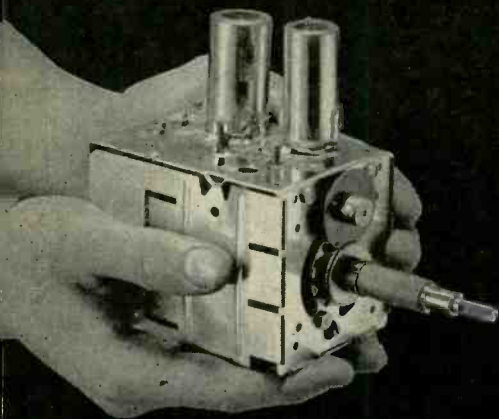

ALL LABOR AND PARTS

(EXCEPT TUBES & TRANSISTORS)*

995



VHF



UHF



COLOR



U-V



COLOR TUNERS



TRANSISTOR

Guaranteed Color Alignment—No Addit. Charge

Simply send us the defective tuner complete; include tubes, shield cover and any damaged parts with model number and complaint. Your tuner will be expertly overhauled and returned promptly, performance restored, aligned to original standards and warranted for 90 days.

UV combination tuner must be single chassis type; dismantle tandem UHF and VHF tuners and send in the defective unit only.

Exact Replacements are available for tuners unfit for overhaul. As low as \$12.95 exchange. (Replacements are new or rebuilt.)

Pioneers in TV Tuner Overhauling

CASTLE

TV TUNER SERVICE, INC.

MAIN PLANT: 5715 N. Western Ave., Chicago 45, Illinois
 EAST: 41-96 Vernon Blvd., Long Island City 1, N.Y.
 IN CANADA: Castle Television Services, Ltd. . . .
 Nation-wide service

*Major Parts are additional



Edward Fuchs of Bell Labs with wire drawing machine he helped design.

tated liquid. By scrubbing the wire clean of foreign particles with ultrasonics it is possible to draw copper wire from .01 to .003 in. in diameter at 1,000 feet a minute with 9 dies, instead of the 14 required by older methods.

FCC CATCHES LAW VIOLATORS

Citizens-band operators need not feel that they are the only ones called to account and fined by the FCC. The large number of Citizens-band operators and their inexperience do result in large numbers of prosecutions. But some staid and sober business organizations have strayed as well. A recent report of the FCC lists monetary forfeitures against two ship stations, two taxicab stations and other business li-

censees. A public coast station was also fined \$100 for repeated failure to operate within its prescribed frequency tolerance.

Most interesting of all were three citations against police radio stations, each of which was assessed \$100, one for repeated failure to operate within frequency tolerances, and two for repeated failure to respond to official communications.

LASER TELEPHONE LINK TO OPEN IN MOSCOW

A 3-mile laser link between two Moscow city exchanges is to be opened soon, according to the newspaper *Trud*. The laser beam has already been operating experimentally in fog and rain, which present the

continued on page 13

DR. HARRY F. OLSON HONORED

Dr. Olson (right) is presented with the Maker of the Microphone Award for outstanding scientific contributions to the world of sound. Dr. Olson, director of the Acoustical and Electromechanical Research Laboratory, RCA Labs, Princeton, N. J., was given the award for a number of contributions, chief of which was the development of the velocity microphone. The award was presented by Oliver Berliner (left) in memory of his grandfather, Emile Berliner, credited with the invention of the microphone, disc record and player, and is the third such award presented by the Berliner family.



◀ Circle 5 on reader's service card

www.americanradiohistory.com

Some plain talk from Kodak about tape:

The meat of the matter... and some boxing news

Undistorted output from a tape—as from any other link in the chain of audio components—is at the very heart of high fidelity enjoyment. Distortion (or the lack of it) is in theory simple enough to evaluate. You start out with something measurable, or worth listening to, and you reproduce it. Everything added, subtracted or modified by the reproduction, that can be measured or heard, is distortion. Since most kinds of distortion increase as you push any component of your system closer to its maximum power capability, you have to label your distortion value to tell whether you did this while coasting or at a hard pan.

Cry “uncle”

To make the distortions contributed by the tape itself big enough to measure and control, we simply drive the tape until it hollers “uncle” and use that power reference as our benchmark. Here’s the procedure. Record a 400-cycle signal (37.5-mil wavelength at 15 ips) and increase its level until in a playback, which is itself pristine, you can measure enough 1200-cycle signal (third harmonic) to represent 2% of

the 400-cycle signal level. This spells “uncle!” We use 400 cycles for convenience, but insist upon a reasonably long wavelength because we want to affect the entire oxide depth.

The more output level we can get (holding the reproduce gain constant, of course) before reaching “uncle,” the higher the undistorted output potential of the tape.

Simple, what?

“Wadayamean — undistorted output at two percent?”

That’s what makes a Miss America Contest. Two percent third harmonic is a reference point that we like to contemplate for a picture of oxide performance. Since distortion changes the original sound, it becomes a matter of acumen and definition how little a change is recognizable. If you’re listening, two percent is a compromise between a trained and an untrained ear. If you’re measuring, it comes at a convenient point on the meter. It’s like a manufacturer testing all sports cars at 150 mph, even though some cars are driven by connoisseurs and some by cowboys. Same goes for tape. Two per-

cent tells us a lot about a tape even if, on the average, you never exceed the 0.5% level.

Because undistorted output helps to define the upper limit of the dynamic range, it has a further effect on the realism of the recording. The higher the undistorted output, the easier it is to reproduce the massed timpani and the solo triangle each at its own concert hall level. And this is just another area where Kodak tapes excel... our general-purpose/low-print tape (Type 31A) gives you up to 3 decibels more crisp, clean output range than conventional tapes.

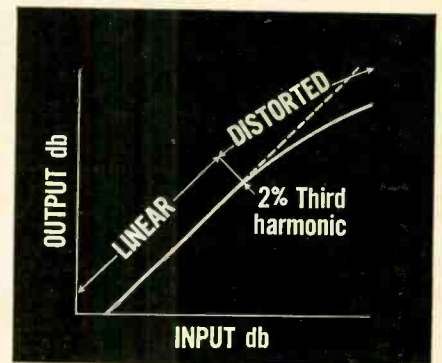

2% third harmonic distortion represents the practical limit to linear recording.

Kodak tapes—in the five- and seven-inch sizes—now look as good as they sound. We’ve put package identification on a removable sleeve and designed a tape library box with a smart new look. This box features durable one-piece construction, full index space, plus detailed tape use instructions on the inside. Kodak Sound Recording Tapes are available at most electronic, camera, and department stores.

New 24-page, comprehensive “Plain Talk” booklet covers all the important aspects of tape performance, and is free on request. Write: Department 8, Eastman Kodak Company, Rochester, N. Y. 14650.

The great unveiling — Kodak’s new library box with removable sleeve!



EASTMAN KODAK COMPANY, Rochester, N. Y.

Circle 6 on reader's service card

Discover the excitement of learning Electronics with training kits NRI sends you

New Achievement Kit Custom Training Kits "Bite Size" Texts

Only NRI offers you this pioneering method of "3-Dimensional" home-study training. It's the result of more than half a century of simplifying, organizing, dramatizing subject matter. As an ambitious man you can effectively learn the Electronics field of your choice the NRI way. But NRI training is more than kits and texts. It's personal services, too, which have made NRI a 50-year leader in the home-study field.

YOU GET MORE FOR YOUR MONEY FROM NRI

Everything that you see here is included in just one NRI course. Other courses are equally complete, yet you'll be surprised at the low cost. Text for text, kit for kit, dollar for dollar—your best home study buy is NRI.



*Earn \$3 to \$5 an hour
spare or full time in*
**TV-RADIO
SERVICING**

Want to earn extra money? Looking for a good paying job? Interested in your own full-time business? Radio-TV Servicing is the branch of Electronics offering all these opportunities. In addition to teaching you the facts, NRI shows you how to earn while you learn.

You can learn quickly how to install, maintain and service tube and transistor home and auto radios, TV sets (including booming Color TV), hi-fi and stereo, public address systems. Like thousands of others, you can be earning \$3 to \$5 an hour in spare-time starting soon after you enroll.

*There's glamor and
success awaiting you in*
**BROADCASTING—
COMMUNICATIONS**

Good paying, fascinating positions await competent Communications Operators and Technicians. Broadcast stations, commercial stations, ships, aircraft, land vehicles all need men who know how to maintain and repair transmitting and receiving equipment. With closed-circuit TV, Facsimile, Microwave, Radar, Telemetry and all the communications needs of the Space Age, you can see how important training in this field has become. NRI training includes preparation for your First Class Radiotelephone FCC License. *And you must pass the FCC exam or NRI refunds your tuition in full!*

*Move ahead in America's
fast moving industry as an*
**ELECTRONICS
TECHNICIAN**

There is a serious shortage of qualified Electronics Technicians. Electronics has found its way into hundreds of areas not even dreamed of ten years ago: offices; manufacturing; medical and dental uses; transportation; space exploration; government and military equipment . . . there's no end of opportunity for trained men. This course stresses the basic principles around which most Electronic devices are built; prepares you for many current job openings. Prepare now. Learn Automation, computers, data processing, ultrasonics, telemetry. Whatever your interest in Electronics, you'll find an NRI training plan for you. Check the course of most interest to you on the postage-free card and mail it today for your free NRI Catalog. No obligation. No salesman will call. NATIONAL RADIO INSTITUTE Washington, D. C. 20016.



**More than
50 years of leadership
in Electronics Training**

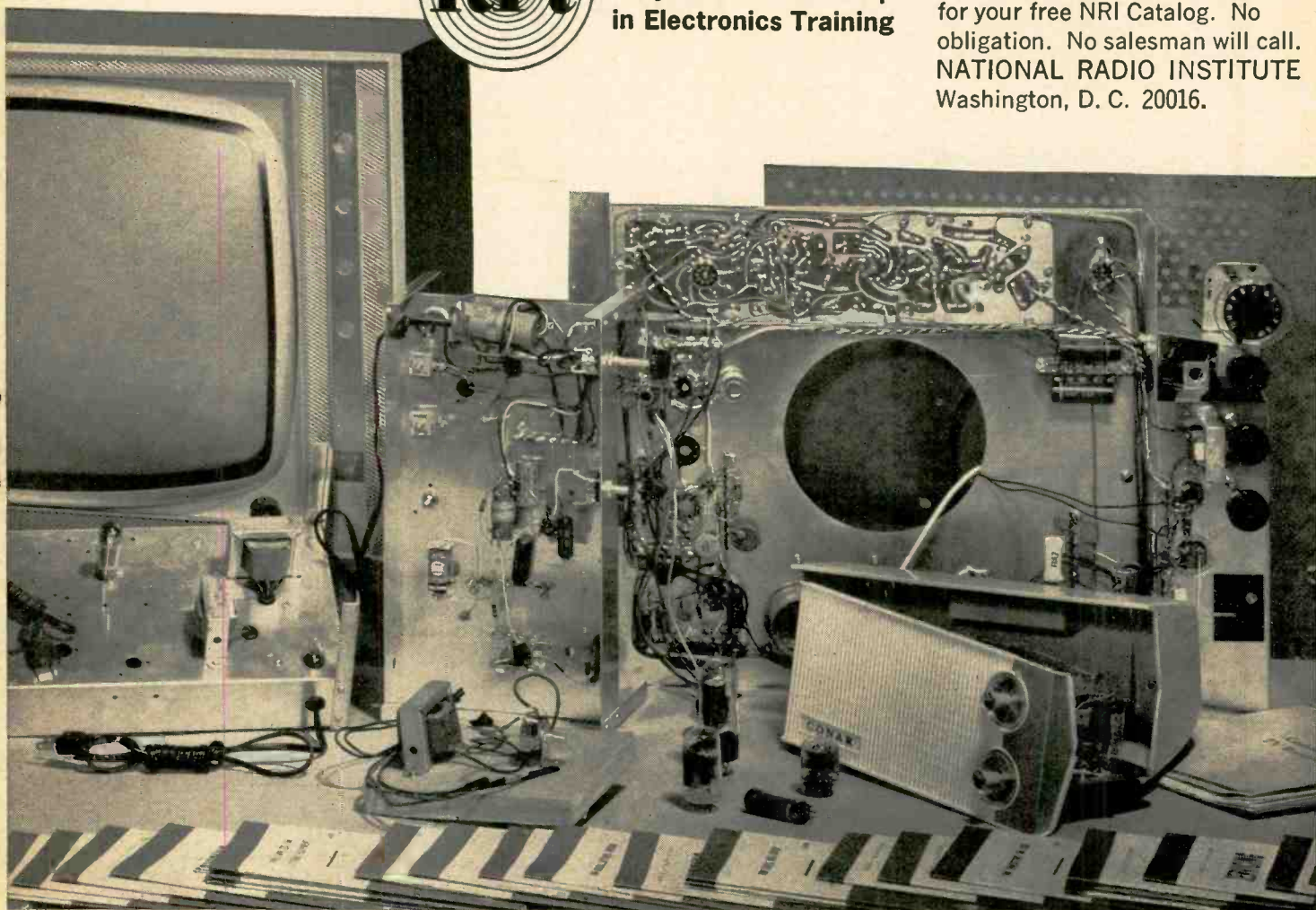

careers for technicians at IBM

To technicians who seek important roles in today's technology, IBM offers careers in the world of computers. Modern computer systems and new solid state technologies have created rewarding jobs for technicians in Research, Development, Manufacturing and Systems Test. IBM is an Equal Opportunity Employer.

Owego, New York

Chemical Technicians: Experience in chemical technology, engineering physics or in any of the following: electrochemistry, lamination, adhesives, electroplating, etching, oxide coating, photo-resist, evaporation techniques.

Electromechanical Technicians: Experience in assembly and maintenance of automatic production equipment. A thorough understanding of mechanical and electrical technologies is essential.

Electronic Technicians: Experience in maintenance, calibration and repair of complex electronic test equipment, and development of high-speed circuitry.

Welder: Mag-lithium experience with toolmaking capability.

Qualifications: A.A.S. degree or its equivalent in education or experience.

Please write, outlining your education and experience, to:

D. J. Carlson, Dept. 649N
IBM Corporation
Space Guidance Center
Owego, New York 13827

IBM

Endicott, New York

Process Engineering Technicians: Planning, design or construction of automatic processing equipment. A.A.S. degree or formal tool and modelmaker training required. Related experience preferred.

Electrical Designers: Requires A.A.S. degree or equivalent training in electrical technology. Experience needed in solid state circuitry and printed circuits for design of automatic component and handling equipment.

Toolmakers: Must have completed formalized tool and modelmaker apprentice program; 2 years' experience working to close tolerances on dies, fixtures, gauges and special machine tools.

Please write, outlining your education and experience, to:

J. C. Lloyd, Dept. 649N
IBM Corporation
1701 North Street
Endicott, New York 13760

IBM

Fishkill, New York

Electromechanical Technicians: Experienced in assembly and maintenance of automated production equipment. A thorough understanding of mechanical and electrical technologies is essential.

Designers: Mechanism design of automatic production equipment.

Electronic Technicians: Experienced in maintenance, calibration and repair of complex electronic test equipment, and development of high-speed circuitry.

Semiconductor Technicians: Experienced in semiconductor process development and manufacturing.

Toolmakers: Building of semiautomatic and automatic tooling to extreme close tolerances.

Qualifications: A.A.S. degree or its equivalent in education or experience.

Please write, outlining your education and experience, to:

T. F. Flaherty, Dept. 649N
IBM Corporation
East Fishkill Facility, Route 52
Hopewell Junction, New York 12533

IBM

Kingston, New York

Electronic Technicians: For work assignments with the Kingston manufacturing test organization. Upon completion of initial training, qualified applicants will be given positions involving testing, trouble-shooting and repairing core storage units, tape drives, display devices, drums, transmission control equipment and other peripheral devices associated with some of the world's largest and most advanced electronic data processing equipment. Qualifications: A.A.S. degree in electronic technology preferred; a certificate of completion from an accredited 2-year technical school or equivalent experience will be considered.

Please write, outlining your education and experience, to:

P. Palker, Dept. 649N
IBM Corporation
Neighborhood Road
Kingston, New York

IBM

NEWS BRIEFS continued

most difficult conditions for laser transmission, according to the newspaper. The beam links a skyscraper building of the Moscow University, outside the southwest section of the Soviet capital, with a telephone exchange near the center of the city. The report states that it will transmit simultaneously "tens of thousands of telephone calls" and "tens of standard television channels."

INTERFERENCE CONTROL ACT MAY COME IN '66

Bill S. 1015, which would give the Federal Communications Commission power to set manufacturing standards on permissible radiation from radios, TV sets, or other electrical or electronic devices, is expected to be acted upon by the Senate Commerce Committee in the 90th Congress.

At present, the FCC cannot compel a manufacturer to construct equipment with radiation below FCC standards. Only when the equipment is in the hands of the user and actually produces radiation is the FCC empowered to proceed against the owner, confiscate the equipment and levy fines and even imprisonment.

The FCC has made more than one attempt to end this absurd situation, and S. 1015 appears to be the most promising of those attempts.

SPACE COOPERATION

NASA and the USSR Soviet Academy of Sciences reached two satisfactory understandings on space cooperation in New York. The first reaffirms an agreement for exchange of weather satellite data between Washington and Moscow. The second is a new agreement for the preparation and publication of a joint review of research in space biology and medicine in the two countries.

LIGHTNING DETECTORS HELP FIGHT FIRE

The U. S. Forest Service's Northern Forest Fire Laboratory at Missoula, Mont. is using electronic detectors to pick up an electromagnetic field, such as that from a lightning bolt, and by triangulation locate forest areas struck by lightning. Foresters then fly over the area in planes equipped with infrared scanners that detect the heat of small fires the lightning may have started. With this infrared scanning they can detect fires at night, while formerly fires were of-

ten not discovered until smoke columns were seen the next day.

CALENDAR OF EVENTS

Winter Meeting, National Society of Professional Engineers, Jan. 5-8; Americana Hotel, Miami Beach, Fla.

Electrical & Electronic Measurements Test Instrument Conference (EEMTIC), Jan. 10-12; Ottawa, Can.

International Symposium on Information Theory, Jan. 31-Feb. 12; UCLA, Los Angeles, Calif.

International Solid-State Circuits Conference, Feb. 9-11; Univ. of Pa. & Sheraton Hotel, Philadelphia, Pa.

International Exhibition of Electronic Components, Feb. 3-8; Porte de Versailles, Paris
Philadelphia High-Fidelity Music Show of 1966, Feb. 18-20; Benjamin Franklin Hotel, Philadelphia, Pa.

IEEE CONVENTION PLANS

The IEEE Convention Program Committee has announced preliminary plans for the 1966 Convention, to be held March 21-through 25 at the Coliseum and the New York Hilton Hotel. All technical sessions will be at the hotel:

Mon. 9:30 am—noon; 2:00 pm—4:30 pm
Tues., Wed., Thurs. 9:00 am—11:30 am; 2:00—4:30 pm
Fri. 9:00 am—11:10; 11:20 am—1:30 pm

BRIEF BRIEFS

Dr. P. H. Fang of NASA's Goddard Space Flight Center has discovered that silicon solar cells damaged by electron radiation can be completely restored any number of times when subjected to high temperatures for a time.

A five-man board composed of two TV industry members and three public members has been named by the Connecticut General Assembly to examine and certify all persons engaged in installing and repairing television equipment. **END**

RADIO-ELECTRONICS is published by Gernsback Publications, Inc.
Chairman of the Board: Hugo Gernsback
President: M. Harvey Gernsback
Vice President-Secretary: G. Aliquo
Vice President-Treasurer: Charles A. Raible
Editorial, Advertising, Subscription and Executive offices: 154 West 14th Street, New York 10011.

Subscribers: When requesting change of address please furnish an address label from a recent issue. Allow one month for change of address.

ADVERTISING REPRESENTATIVES: East: John J. Lamson, Eastern Sales Manager, RADIO-ELECTRONICS, 154 West 14th Street, New York 10011, 212 AL 5-7755; Midwest: P. H. Dempers Co., 740 North Rush Street, Chicago, Illinois 60611, 312 MI 2-4245; South Central: Media Representatives, Inc., 2600 Douglas Avenue, Irving, Texas 57060, 214 BL 5-6573; West Coast: J. E. Publishers' Representative Co., 8380 Melrose Avenue, Los Angeles, California, 90069, 213-653-5841; 420 Market Street, San Francisco, California, 94111, 415-981-4527; United Kingdom: Publishing & Distributing Co., Ltd., Mitre House, 177 Regent St., London W.1, England.

Complete TUNER REPAIR

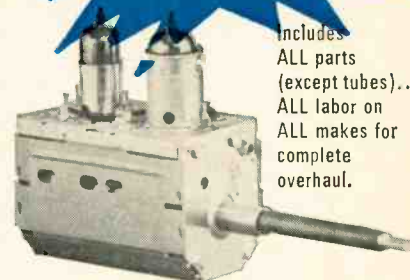

Includes ALL parts (except tubes)... ALL labor on ALL makes for complete overhaul.

FAST, 24-HOUR SERVICE with FULL YEAR WARRANTY

Sarkes Tarzian, Inc., largest manufacturer of TV and FM tuners, offers unexcelled tuner overhaul and factory-supervised repair service.

Tarzian-made tuners received one day will be repaired and shipped out the next. More time may be required on other makes. Every channel checked and realigned per original specs. And, you get a full, 12-month guarantee against defective workmanship and parts failure due to normal usage. Cost, including labor and parts (except tubes) is only \$9.50 and \$15 for UV combinations. Replacements at low cost are available on tuners beyond practical repair.

Always send TV make, chassis and Model number with faulty tuner. Check with your local distributor for Sarkes Tarzian replacement tuners, parts or repair service. Or, use the address nearest you for fast, factory-supervised repair service.

SARKES  TARZIAN

TUNER SERVICE DIVISION
537 S. Walnut St., Bloomington, Ind.
Tel: 812-332-6055

10654 Magnolia Blvd., N. Hollywood, Calif.
Tel: 213-769-2720

TUNER SERVICE  CORPORATION

(Factory-supervised tuner service authorized by Sarkes Tarzian, Inc.)

547 Tonnele Avenue, Jersey City, N.J.
Tel: 201-792-3730

Manufacturers of Tuners, Semiconductors, Air Trimmers, FM Radios, AM-FM Radios, Audio Tape and Broadcast Equipment

Grooveless record demonstrates anti-skating on the

Garrard[®]
LAB 80



Due to the offset angle of any cartridge and the rotation of the record, all tone arms tend to skate towards the center as you see in this blank disc. The grooves on ordinary records generally keep the tone arm in place, but a side pressure is constantly present, causing poor tracking, right channel distortion, and uneven record wear.



The Lab 80 Automatic Transcription Turntable has a patented, simple anti-skating control which equalizes the pressure. Here you see that even on the same blank record, the Lab 80 tone arm tracks perfectly, as if there were grooves!



Ask your dealer to demonstrate this important feature, or for a complimentary copy of a Comparator Guide fully describing the Lab 80, write Garrard, Dept. GA-386, Westbury, N.Y. 11591.

LAB 80—\$99.50 less base and cartridge

Circle 7 on reader's service card

Correspondence

TOP-CAP-CATHODE TUBES ✓

Dear Editor:

Mr. Al Yeager in his letter about tube proliferation in Correspondence in the October issue of RADIO-ELECTRONICS mentions that he has not seen a vacuum tube with the plate connection on the bottom and the cathode on the top.

A number of Canadian black-and-white TV sets use the 6AL3 (EY88), with this type of construction. It is a nine-pin damper diode with the cathode connected to a cap on the top of the glass envelope, and the plate and heater connected to the bottom pins.

This 6AL3 cannot be tested on older tube testers, nor on drugstore checkers, so the do-it-yourself customer must use the substitution method or purchase a 6AL3 from his TV service technician.

I find RADIO-ELECTRONICS' articles on new electronics developments and on servicing electronic equipment interesting and useful.

J. W. CLARKE

Toronto, Ont.

[Since Mr. Yeager's letter was printed, we, too, have discovered a tube whose cathode connection is the top cap: Amperex's new 6EC4, also a damper. You'll find it described on page 86 of this issue.—Editor]

MIKE FOR ELECTRONIC STETHOSCOPE

Dear Editor:

Regarding the letter that appeared in the July 1965 Service Clinic: In my days as a high school physics teacher, two students wanted to make a study of heart sounds as related to variables such as exercise, etc. Since our budget would not allow us to buy the special Shure microphone for the purpose, some investigation was done to find a suitable substitute.

We found that a small PM speaker served the purpose admirably. Since we were using a tube amplifier, we used a stepup transformer; for a transistor amplifier this might not be necessary if the proper speaker impedance were chosen. Our results were excellent—we could do oscillographic analyses of heart sounds.

J. EVANS JENNINGS, JR.

Lindenwold, N. J.

HOW TO HEAR 5.5-MC TV SOUND

Dear Editor:

There is a simple way to receive the sound carrier from German television transmissions on American TV sets. I used this method for 2 years while stationed in Germany.

A separate FM radio set must be available. Wrap about eight turns of insulated No. 22 wire around the first video amplifier tube and connect the other end (bare, of course) to the antenna input of the FM set. Set the dial of the FM set to the low end of the band. Tune in the picture on the TV set. Very carefully tune for the TV sound on the FM set. At first this method is tricky, for the received second harmonic on the FM radio will shift as the TV dial is adjusted. There will be a slight amount of hum, but it will not be noticed if the FM radio tone control is set to treble.

PAUL D. MAXAM

Eau Gallie, Fla.

FOOLPROOFING THE DUO (MORE) ✓

Dear Editor:

The transistor duo presented by Rufus P. Turner (September R-E, p. 39) needs a bit of refinement before it can be really useful.

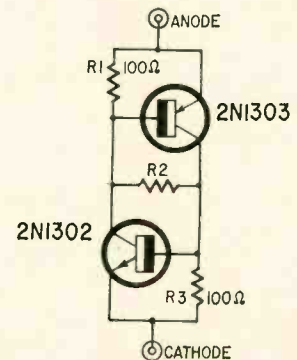

THE IMPROVED DUO

Mr. Turner revealed that the "secret" of making a transistor pair behave is the addition of a resistor across the base-emitter junction of the n-p-n transistor. The resistor, he explained, produces a signal voltage "high enough to drive the n-p-n vigorously." This explanation is absolutely backward! That resistor actually *reduces* the drive to the n-p-n. And well it should. Without it you have two stages in cascade with 100% positive feedback. When the voltage comes on, the slightest leakage in either transistor gets amplified and regenerated, causing instant and total conduction through the duo.

What does Mr. Turner's secret solution do? It merely prevents premature turn-on. With it connected, the leakage current gets up to 400 μ a before the duo fires. By that time there is enough volt-

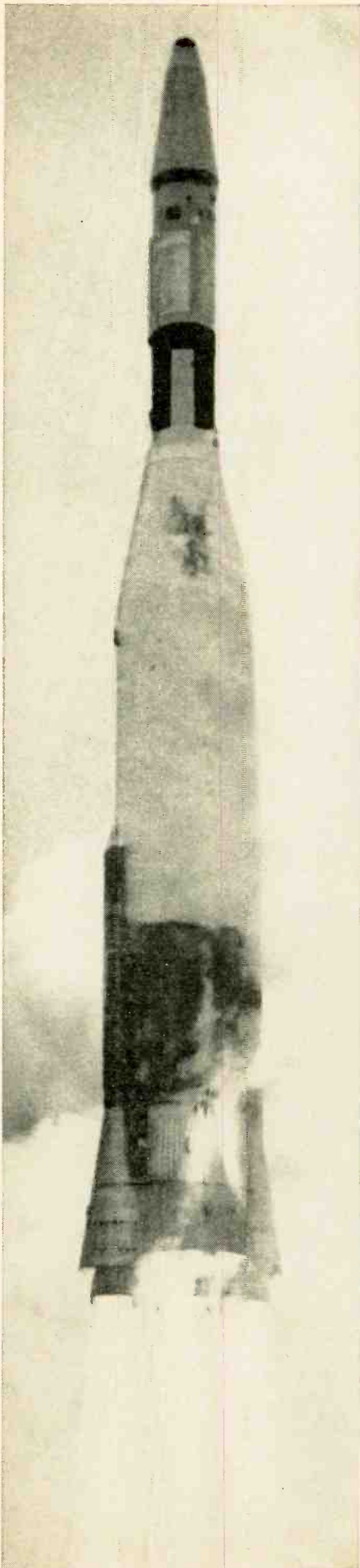

**America's most successful
space programs have it.**

**RCA Victor Color TV
has it.**



**The reliability of RCA circuitry.
The solid kind.**

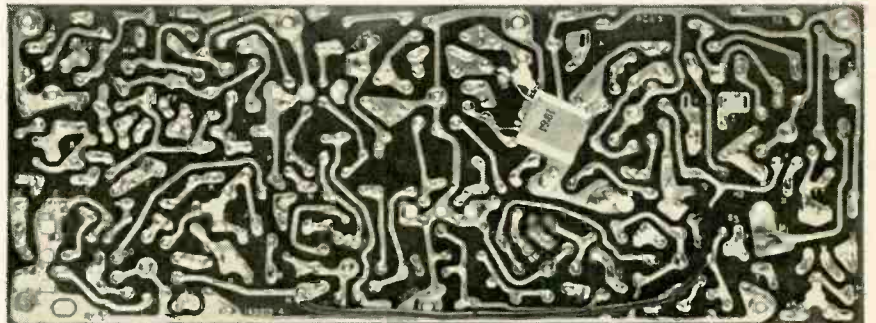

Solid Copper circuit, shown, from RCA Victor Color TV.

**RCA Solid Copper Circuits
won't come loose. Won't short
circuit. Won't go haywire. They're
the latest advance over
old-fashioned "hand wiring" and
bring Space Age dependability
to Color TV.**



The Most Trusted Name in Electronics

Trmk(s)®

age across it that negative resistance can occur as the current increases. However, that firing voltage is strongly temperature-dependent, because leakage in semiconductors doubles with every 10° rise.

To make that firing voltage more stable, we must prevent leakage current from firing it. Most four-layer diodes have a center junction which avalanches at a specific "Zener" voltage and triggers turn-on. A Zener diode could indeed be used with a pair of transistors to match the behavior of the four-layer diode, but the latter would be better and cheaper.

A fairly good compromise is shown in the diagram. Parts cost is \$1.21. The transistors were chosen for low leakage, high voltage rating and low price. R1 and R3 prevent the amplification of leakage current by either transistor. For the best turn-on characteristic these resistors should be equal. This improved duo turns on when the current through R2 reaches 1 ma. With proper choice of R2, you can get stable firing voltages from 1 to 25 volts.

ROBERT W. HARRIS

Accokeek, Md.

NEAT FILTER TRICK

Dear Editor:

I believe I can improve on or at least offer an alternate approach to Andy Maxim's "Filer for Battery Eliminator" (Try This One, August 1965).

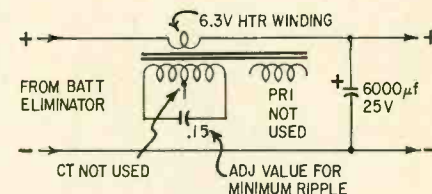

I used the filament winding of an old TV power transformer as an inductor with one very special refinement: I resonated it at the ripple frequency (120 cycles). This is very economical if you put the resonating capacitor in the high-voltage winding. Only a small-value capacitor is required, because it will be reflected across the transformer as the square of the turns ratio.

WAYNE RODERICK

Pocatello, Idaho

KEEP UP "ONE-PIECE" ARTICLES

Dear Editor:

I have been a subscriber (or have purchased newsstand copies) ever since your magazine was called *The Experimenter* many years ago. It is an excellent, well composed and well edited magazine from cover to cover.

I have subscribed to *Electronic Technician* and *PF Reporter*, but dropped them because the articles are not "together". Almost every article of more than one page, it seems, is scattered in a haphazard manner through the entire magazine. One cannot remove and file the "pages" in a notebook, because the many little pieces become lost, or at other times, the "continued on page so-and-so" items have articles on the other side, making filing or indexing impossible.

I trust you will continue to keep your items close together, and place them in the magazine so that they can be removed as successive pages.

A. F. REDMAN

Ogden, Utah

END

TRY CAPACITOR-DISCHARGE IGNITION

for your car. Costs a little more than conventional or transistor ignition, but worth it! Better firing of fouled plugs, less drain from the battery, no weak or missed sparks from breaker-point bounce. Uses reliable SCR circuit with transistor power inverter.

Coming in February
RADIO-ELECTRONICS

RADIO-ELECTRONICS

The famous MERCURY Model 1101 TUBE TESTER NOW in a wire-it-yourself KIT!

illustrated
step-by-step
instructions
make the
Model 1101
easy-to-
build...

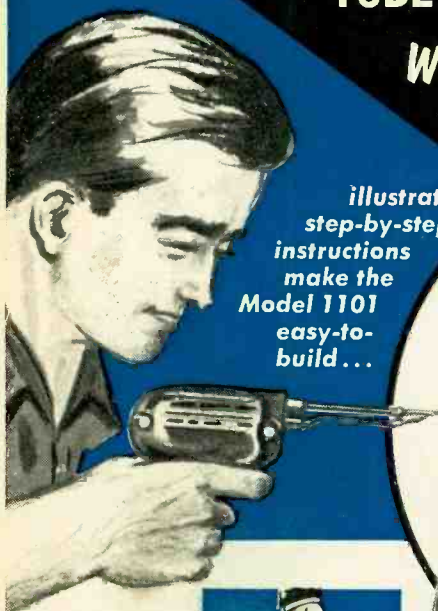

A PORTABLE MASTERPIECE

Modern, airplane luggage design scuff-proof gray case... Weighs only 4 lbs. 8 1/8" x 11 3/8" x 3 1/4".



Nothing has been spared, engineering-wise or production-wise in making the Model 1101 your best tube tester buy. Tests more tubes for dynamic cathode emission, shorts, grid leakage and gas than many testers costing hundreds of dollars. Will test the new Decals, the new 7-pin Nuvistors and the new Magnovals. Also tests Compactrons, 10-pin types, Novars, Nuvistors, battery type, auto radio hybrid tubes foreign and hi-fi tubes and industrial tube types. Includes the most complete tube chart in the field.

• Also tests all popular picture tubes

\$34.95 Net

Model 1101K...Kit.....
Model 1101...Wired... **\$49.95** Net

See your parts distributor...
or write for complete catalog

Mercury ELECTRONICS CORPORATION
manufacturers of quality electronics products

315 Roslyn Road, Mineola, New York 11501

In Canada: William Cohen Corp.
Export: Morhan Exporting Corp., 458 Broadway, New York, N.Y. 10013

Free Photofact® Annual Index

for your use
throughout 1966

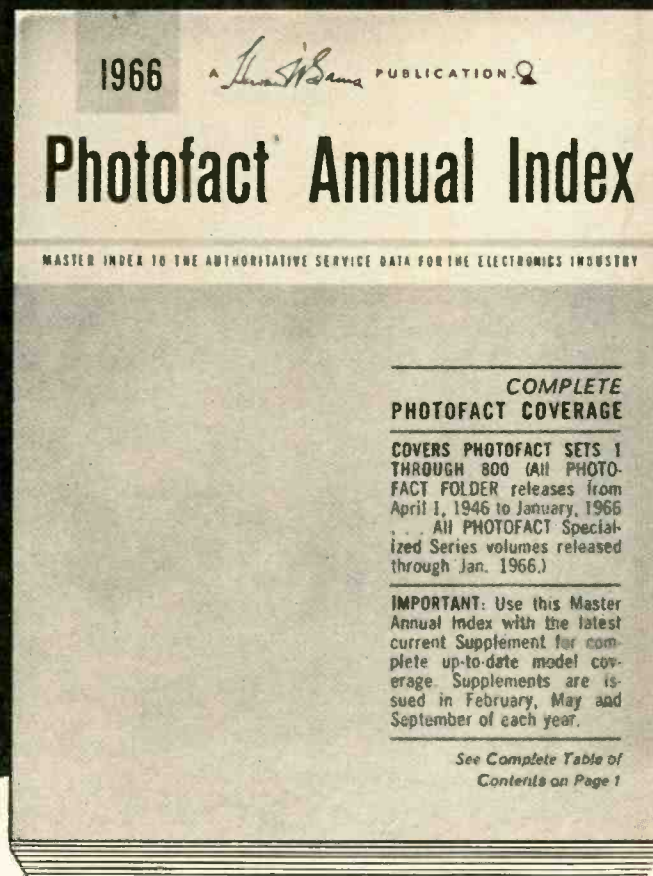

send today for your instant handy guide to the world's finest electronic service data!

covers over 65,000 listings of:
TV Receivers • Home & Auto Radios • Phonos & Hi-Fi
CB Radios • Tape Recorders • Record Changers

NOW INCLUDES—

- Special Index to Color TV Receivers
- Complete Listing of Sams Technical Books
- Complete List of Sams Distributors

Send today for this valuable 128-page guide covering virtually every model of home-entertainment electronic equipment produced since 1946! Helps you locate the proper PHOTOFACT Folder to quickly solve any service problem in any model. PHOTOFACT provides *everything* you need in complete, uniform style for quick, effective repairs: Famous Standard Notation Schematics packed with the service details you need; Full Photo Coverage of all chassis views; Complete Replacement Parts Lists; Tube Placement Diagrams; Alignment Instructions; CircuiTrace® for printed boards; Disassembly Instructions; Dial Cord Diagrams; Changer and Recorder "Exploded Views"—plus dozens of other great features. Send coupon for your FREE copy of the latest PHOTOFACT Index to the service data you need!

FREE! Famous 14-volume NEW STANDARD ENCYCLOPEDIA—the supreme gift for your family—FREE with your purchase of a PHOTOFACT Library! This invaluable Treasury of Knowledge for all the family sells at retail for \$149.50—now yours FREE with the purchase of 225 PHOTOFACT Sets or more. See your Sams Distributor for the exciting details, or send coupon today!

**NEW "PHOTOFACT ANNUAL INDEX" AND
3 SUPPLEMENTS NOW PROVIDE COMPLETE
REFERENCE TO PHOTOFACT COVERAGE:**

Send for the Photofact Annual Index—your "master" reference throughout 1966. Once you are on our mailing list, you will automatically receive three additional Index Supplements (in February, May, and September, 1966) to keep you up-to-the-minute on Photofact coverage of the latest equipment released.



HOWARD W. SAMS & CO., Dept. REF-1
4300 W. 62nd St., Indianapolis, Indiana 46206

- Send FREE 1966 Photofact Annual Index and place my name on your mailing list to receive the Supplements
- Send full information on FREE Encyclopedia Offer, Easy-Buy Photofact Library Plan and Standing Order Subscription
My Distributor is _____

Shop Name _____

Attn.: _____

Address _____

City _____ Zone _____ State _____

Circle 10 on reader's service card

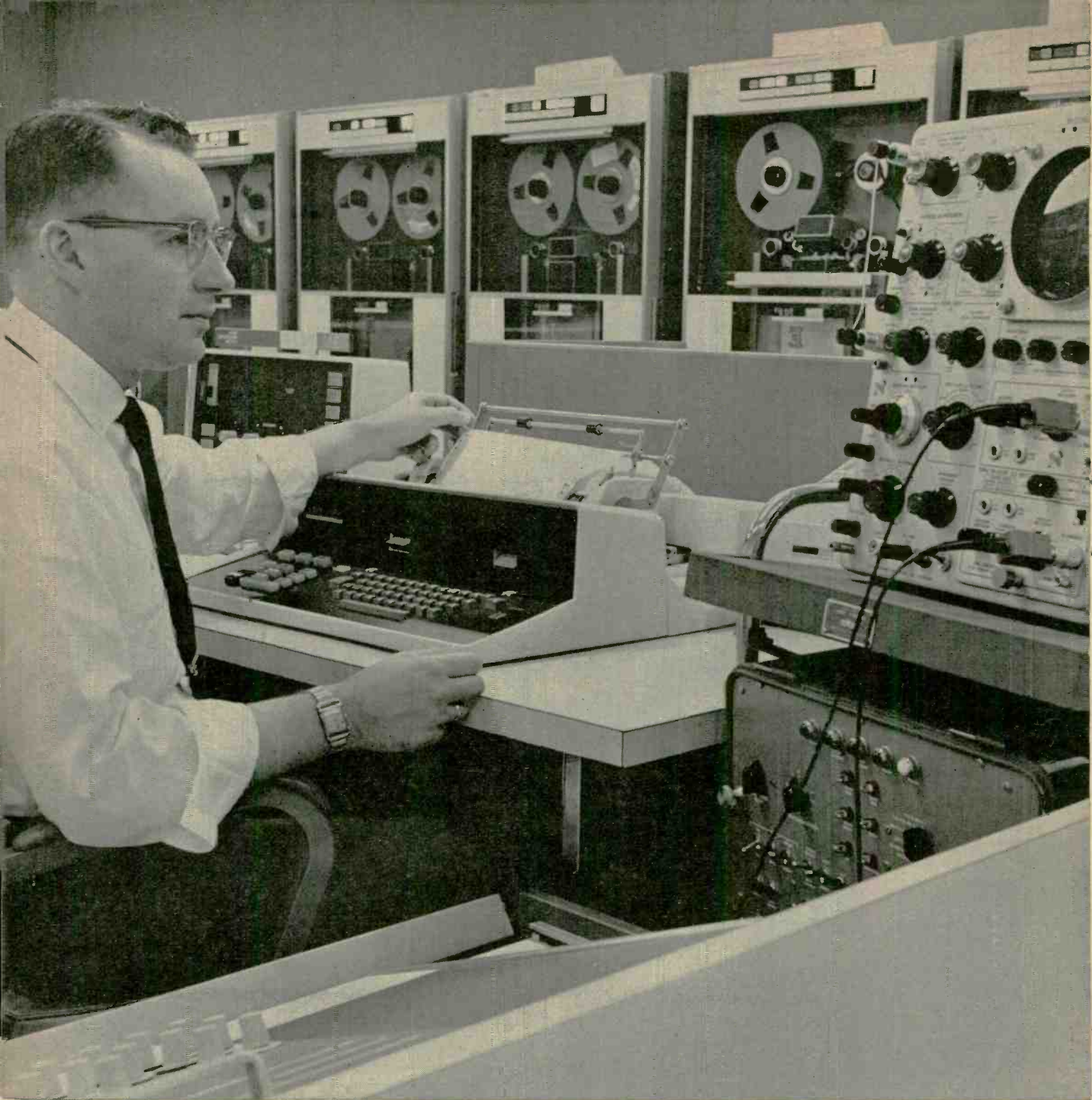

Why Fred got a better job . . .

I laughed when Fred Williams, my old high school buddy and fellow worker, told me he was taking a Cleveland Institute Home Study course in electronics. But when our boss made him Senior Electronic Technician, it made me stop and think. Sure I'm glad Fred got the break . . . but why him . . . and not me? What's he got that I don't. There was only one answer . . . his Cleveland Institute Diploma and his First Class FCC License!

After congratulating Fred on his promotion, I asked him what gives. "I'm going to turn \$15 into \$15,000," he said. "My tuition at Cleveland Institute was only \$15 a month. But, my new job pays me \$15 a week more . . . that's \$780 more a year! In

twenty years . . . even if I don't get another penny increase . . . I will have earned \$15,600 more! It's that simple. I have a plan . . . and it works!"

What a return on his investment! Fred should have been elected most likely to succeed . . . he's on the right track. So am I *now*. I sent for my three *free* books a couple of months ago, and I'm well on my way to Fred's level. How about you? Will you be ready like Fred was when opportunity knocks? Take my advice and carefully read the important information on the opposite page. Then check your area of most interest on the postage-free reply card and drop it in the mail *today*. Find out how you can move up in electronics too.

How You Can Succeed In Electronics

... Select Your Future From Five Career Programs

The "right" course for your career

Cleveland Institute offers not one, but five different and up-to-date Electronics Home Study Programs. Look them over. Pick the one that is "right" for you. Then mark your selection on the reply card and send it to us. In a few days you will have complete details ... without obligation.

1. Electronics Technology

A comprehensive program covering Automation, Communications, Computers, Industrial Controls, Television, Transistors, and preparation for a 1st Class FCC License.



2. First Class FCC License

If you want a 1st Class FCC ticket *quickly*, this streamlined program will do the trick and enable you to maintain and service all types of transmitting equipment.

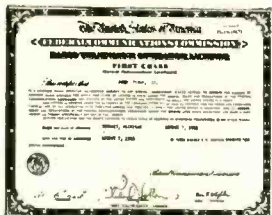

3. Broadcast Engineering

Here's an excellent studio engineering program which will get you a 1st Class FCC License and teach you all about Program Transmission and Broadcast Transmitters.



4. Electronic Communications

Mobile Radio, Microwave, and 2nd Class FCC preparation are just a few of the topics covered in this "compact" program ... Carrier Telephony too, if you so desire.

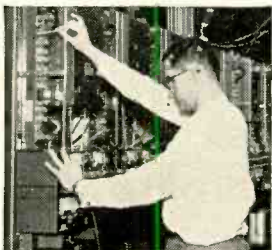

5. Industrial Electronics & Automation

This exciting program includes many important subjects such as Computers, Electronic Heating and Welding, Industrial Controls, Servomechanisms, and Solid State Devices.

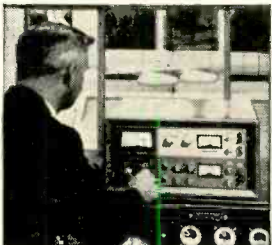

An FCC License ... or your money back!

In addition to providing you with comprehensive training in the area indicated, programs 1, 2, 3, and 4 will prepare you for a Commercial FCC License. In fact, we're so certain of their effectiveness, we make this *exclusive* offer:

The training programs described will prepare you for the FCC License specified. Should you fail to pass the FCC examination after completing the course, we will refund *all* tuition payments. You get an FCC License ... or your money back!

CIE's **AUTO-PROGRAMMED** lessons help you learn faster and easier

Cleveland Institute uses the new programmed learning approach. Our **AUTO-PROGRAMMED*** lessons present facts and concepts in small, easy-to-understand bits ... reinforce them with clear explanations and examples. Students learn more thoroughly and faster through this modern, simplified method. You, too, will absorb ... retain ... advance *at your own pace*.

*TRADEMARK

Free nationwide job placement service ... for life, for every CIE graduate

Once enrolled with CIE, you will get a bi-monthly listing of the many high-paying interesting jobs available with top companies throughout the country. Many Cleveland Institute students and graduates hold such jobs with leading companies like these: American Airlines, American Telephone and Telegraph, General Electric, General Telephone and Electronics, IBM, Motorola, North American Aviation, New York Central Railroad, Raytheon, RCA and Westinghouse.

Electronics is a fast moving, dynamic industry ... Cleveland Institute keeps you current

The Electron Bulletin is CIE's bi-monthly digest of new developments in the world's fastest growing industry. As a CIE student, you will get a free copy throughout your training to keep you up-to-date on Masers, Lasers, Solid State Devices, and other new inventions.



Full accreditation ... your assurance of competence and integrity

Cleveland Institute of Electronics is accredited by the Accrediting Commission of the National Home Study Council. You can be assured of competent electronics training by a staff of skilled electronics instructors.

Your Future In Electronics Is Up To You. Make It A Brighter One. Mail Reply Card Today.

CIE

Cleveland Institute of Electronics

1776 East 17th Street, Dept. RE-12, Cleveland, Ohio 44114

SERVICE CLINIC

By JACK DARR Service Editor

THE VERTICAL OUTPUT STAGE IN COLOR SETS

THE VERTICAL OSCILLATOR/OUTPUT stage in a color set is important. It does a lot more than just waggle an electron beam up and down. It's these other jobs it has that can give us the headaches if we forget 'em.

We get two very important waveforms from the vertical output transformer: the sweep *and* the vertical convergence. If the sweep isn't linear, we see the familiar signs—compression, foldover and so on. If the convergence waveform is distorted, we get color fringing. Troubles in this stage show up all over the place!

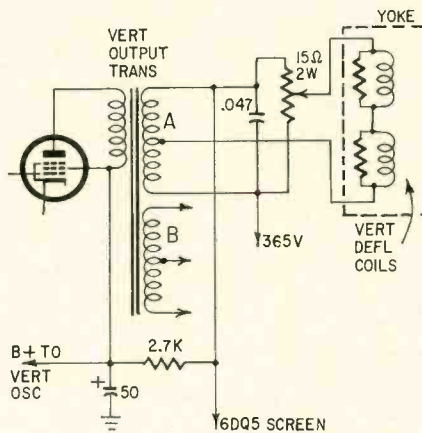

Fig. 1

Fig. 1 shows the vertical output transformer and yoke, but notice the differences from the usual black-and-white set. The little 15-ohm pot across the secondary controls a small direct current that flows through the yoke. This gives us an adjustable, "permanent" magnetic field which controls the vertical positioning of the raster. The B+ is fed to the bottom of the secondary, flows through the whole winding and then on through the primary to the vertical-output-tube plate and other circuits. This is done to get enough current flow here to give the variation needed—

This column is for your service problems—TV, radio, audio or general and industrial electronics. We answer all questions individually by mail, free of charge, and the more interesting ones will be printed here.

If you're really stuck, write us. We'll do our best to help you. Don't forget to enclose a stamped, self-addressed envelope. Write: Service Editor, Radio-Electronics, 154 West 14th Street, New York 10011.

not to get a pulse to feed other circuits. Note how well the current is filtered *after* it goes through the secondary, with a 2,700-ohm resistor and 50- μ f electrolytic.

This happens in secondary A. Now let's look at secondary B, in Fig. 2. We left this for a separate drawing to make it look simpler, which it actually is. It's a center-tapped winding with the center tap grounded so that we can get two identical waveforms of opposite polarity from it. These are duplicates of the yoke drive waveforms since they come from the same place. P-p amplitude in this set (RCA CTC7, -9, etc.) is 10 volts each side. They go to the three tilt controls on the convergence board, and from there into the convergence yoke coils, mixed with a few horizontal waveforms they pick up along the way.

Another waveform, this one a sawtooth at 6 volts p-p, is taken from the cathode of the vertical output tube and fed to the vertical amplitude controls. This is fed on into the convergence yoke and mixed with the rest. Farther along, they're shaped into the parabolic waveforms we need. What we are interested in here is getting the right-shaped waveforms to feed into this circuitry, and this can be checked very simply with a

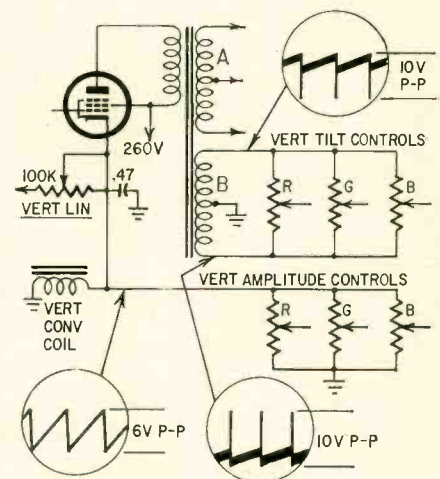

Fig. 2

scope and a direct probe (all is low-impedance here). The waveshapes, of course, depend on the conditions in the vertical oscillator/output stage.

I refuse to draw a schematic of this; it's just a plain plate-coupled multivibrator, the same as that used in jillions of black-and-white sets! The only difference you'll find will be the addition of extra wave-shaping networks, and a little

CONAR ELECTRONIC KITS

Your copy is waiting...

The do-it-yourselfer's newest catalog

Here's your new catalog of quality electronic kits and assembled equipment . . . your shopping guide for TV set kits, transistor radios, voltmeters, scopes, tube testers, ham gear, PA systems, and a host of other carefully engineered products. Every item in the Conar catalog is backed by a no-loopholes, money-back guarantee. It's not the biggest catalog, but once you shop its pages you'll agree it's among the best. For years of pleasurable performance, for fun and pride in assembly, mail the coupon. Discover why Conar, a division of National Radio Institute, is just about the fastest growing name in the kit and equipment business.

CONAR

MAIL NOW!

CONAR

AC 6C

3939 Wisconsin Avenue, Washington, D.C. 20016
Please send me your new catalog.

Name _____

Address _____

City _____

State _____ Z. Code _____

Circle 11 on reader's service card

10 facts you should know about color-bar generators

If you are going to buy a color-bar generator—or even if you already own one—here are several facts you should know.

While other types of test instruments may lack one or more features, they may still be useful in skilled hands—provided the user is aware of their shortcomings and provided he has other means of determining what he must know.

This is not true of a color-bar generator.

A color-bar generator should allow you to walk away from an adjusted receiver knowing that the owner can turn it on and receive color broadcasts in full-fidelity color and sound.

Not all color-bar generators can give you this assurance.

Let's talk facts.

FACT NO. 1: *A gated-rainbow type generator is accepted as the standard of the service industry*

You do not need fully saturated NTSC colors to achieve perfect adjustment any more than you need an FCC-type broadcast signal for tuner and if-amplifier alignment. The gated-rainbow type signals are used by virtually all TV manufacturers in establishing service procedures for their sets.



Gated rainbow color-bar pattern

Urgent service needs for a trustworthy color-signal source were met years ago when RCA introduced the gated-rainbow system.

Today, this basic system is used in nearly all service-type color-bar generators. The waveforms and procedures in nearly all color-TV service notes are based on this system.

FACT NO. 2: *All gated-rainbow type generators are not alike*

In spite of their basic circuit similarities, available models differ in their features, accuracy, and ultimate usefulness. Some of these differences are critical.

FACT NO. 3: *The offset subcarrier oscillator must be controlled within a few cycles of its true frequency*

This oscillator controls the phase angles (hues) of the color-bar pattern. It is the heart of the color-bar generator.

The subcarrier oscillator should be within ± 20 cps of its fundamental frequency of 3.563795 megacycles. In the crystal-controlled RCA WR-64B Color-Bar/Dot/Crosshatch Generator, this deviation is kept well within the ± 20 cps limit.

FACT NO. 4: *Provision must be included to prevent the subcarrier oscillator from drifting off frequency*

The subcarrier oscillator must not only be accurate when the instrument is new—it must

stay accurate. Top-quality components minimize undesirable frequency changes.

Check, for instance, the trimmer capacitor used in the 3.56-Mc subcarrier oscillator. You'll find a piston-type ceramic capacitor—not a flat mica type—in the RCA WR-64B.

FACT NO. 5: *The generator must have an rf-sound carrier to assure proper setting of the fine-tuning control*

Unless your color-bar generator has this essential feature, it may produce a perfect color-bar pattern on the receiver, but at the wrong setting of the receiver fine-tuning control. In such cases, the receiver may not correctly reproduce a color program.

The WR-64B has this necessary feature. With it, you can accurately set the fine-tuning control before making color adjustments. In the WR-64B the rf-sound carrier is also crystal-controlled.

FACT NO. 6: *The rf picture carrier must be exactly on frequency to assure that the color subcarrier is correctly placed in the receiver bandpass*

Drift, faulty adjustment, or aging of components in the rf oscillator section can move the generator picture carrier off frequency. This shift, in turn, will also move the color subcarrier signal away from its correct position in the receiver bandpass. In some receivers, this shift will affect accuracy of color-circuit adjustments.

A separate crystal-controlled oscillator is used in the WR-64B to keep the picture exactly on frequency.

FACT NO. 7: *The axes of the output color-bar pulses should lie on the zero axis—and not on elevated brightness pedestals*

Elevated pulses necessitate use of an oscilloscope for accurate setting of receiver phasing. A generator having zero-axis color-bar pulses, such as the WR-64B, does not require use of an oscilloscope for checking phasing in the customer's home.

FACT NO. 8: *The generator should not require frequent adjustment of internal counter circuits*

All color-bar generators contain circuits which develop vertical and horizontal sync, and dot-and-bar-pattern signals, by dividing or counting down from a higher frequency: usually 189 Kc. If one of these circuits is unstable, the patterns can jitter, ripple, jump sync or contain the wrong number of dots or bars.

Conventional R-C circuits are used in the counters of most generators. But the RCA WR-64B uses inherently stable iron-core in-

ductors in its counters, thereby assuring long-term counter-circuit stability.

FACT NO. 9: *The proper way to check receiver color performance is to feed the generator signal into the antenna terminals*

Color performance depends on overall receiver condition—not on that of a single section alone. A color-test signal fed directly into the video amplifier—rather than through the antenna terminals—will not provide a proper check of the complete receiver. The only method you should use in adjusting the receiver, therefore, is the rf-signal-input method—the method provided by the RCA WR-64B.

FACT NO. 10: *There is no "best" dot size or bar width for convergence adjustments*

Generator dot size or bar width has no significance for convergence adjustments.

Veteran technicians, however, have found that very small dots or thin bars are difficult to use under average lighting conditions. If receiver brightness is turned up to overcome this handicap, blooming will result. Proper convergence cannot be achieved under this abnormal condition.

The dot and bar size of the WR-64B is small enough to permit exact, speedy adjustment, and large enough to be useful under average lighting conditions.

These are ten specific facts you should know about color-bar generators. They add up to this

FACT: *The new RCA WR-64B has all the features you need for complete color-circuit adjustment*

It's the one color-bar generator that meets all servicing requirements—from the company that pioneered and developed the color-TV system now in universal use: RCA!

Order it today from your local Authorized RCA Test Equipment Distributor.

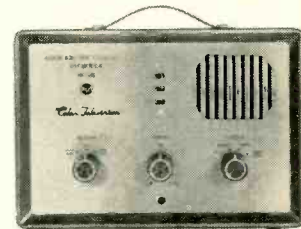

\$189.50* *Optional distributor resale price. May be slightly higher in Alaska, Hawaii and the West. Prices subject to change without notice.

RCA ELECTRONIC COMPONENTS AND DEVICES,
HARRISON, NEW JERSEY



The Most Trusted Name in Electronics

Circle 12 on reader's service card

brand new
... and very important ...

QUAM COLOR TV REPLACEMENT SPEAKERS PREVENT COLOR PICTURE DISTORTION

OFTEN CAUSED BY STRAY
MAGNETIC FIELDS FROM
ORDINARY LOUDSPEAKERS

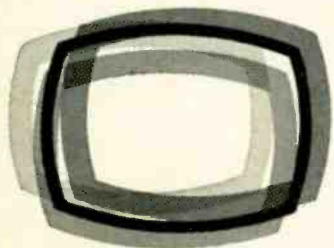

When you use an ordinary loudspeaker in a color TV set, you're looking for trouble ... picture trouble. The external magnetic fields from standard loudspeakers will deflect the primary color beams, causing poor registration and distorted pictures.

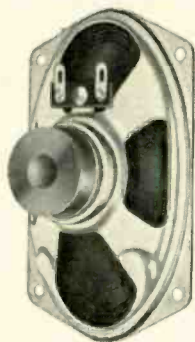

QUAM RESEARCH SOLVES THIS PROBLEM

An entirely new construction technique, developed in the Quam laboratories, encases the magnet in steel, eliminating the possibility of stray magnetic fields and the problems they cause! These new Quam speakers have been eagerly adopted by leading color TV set manufacturers. Quam now takes pride in making them available for your replacement use. Five sizes (3" x 5", 4", 4" x 6", 5 1/4", 8") ... in stock at your distributor.

QUAM

QUAM-NICHOLS COMPANY

234 E. Marquette Rd. • Chicago, Ill. 60637

Circle 13 on reader's service card

more attention to design, for this is a most critical stage. Tolerance is tighter in color sets but, outside of that, they can be checked and repaired in exactly the same way as all the rest.

Troubles are the same—resistors heat up and drift, capacitors develop very small dc leakage, and of course, tubes can get weak or gassy. Grid emission is a more serious problem in color sets, for you'll find very large resistors used in grid circuits—6.8 megohms, 4.7 megohms, and such. Very small grid currents can set up voltage drops that interfere with the correct operation of the stage. If you run into "odd" troubles, be sure to disconnect and measure *all* the high-value resistors. You'll have to unhook 'em, for they're usually connected into a circuit that would make any self-respecting spider swell with pride if she could weave a web like it.

We haven't shown the "service" switch used for setup, but it's simple. All it does, in this circuit, is kill the vertical oscillator, usually by grounding the feedback loop. Here is a point that has caused some confusion. Since we've killed the vertical sweep, we have also changed the vertical convergence waveforms. This is going to change the vertical convergence, quite obviously. Service instructions for early sets using this circuit say "Adjust controls for a thin white line." It doesn't often work out that way! In fact, I've seen more that made three lines than I have that made one. The lines will often be displaced 1/2 inch or more from each other. *This is normal: don't readjust the static convergence!* If you do, when you turn the raster back on you'll be most beautifully *out* of convergence! Adjust for three lines of about equal brightness and go on; the convergence will go back to normal when you open the "service" switch.

A slow-heating tube or a part with thermal drift can cause some odd symptoms. The screen will show a pretty poor vertical convergence while it's warming up. Later, it will go back to perfect convergence all by itself. This is due to distortion of the vertical-convergence waveforms during warmup. If this lasts for 10 or 15 minutes, we usually have to fix it. If it goes away in 3–4 minutes, it usually escapes notice. This depends, of course, on the customer. If it bothers *him*, we fix it!

Change the tubes first and check. If you warm your bar-dot up beforehand, hook it to the set, and then check; you'll be able to see just how badly the set is out and how long the misconvergence lasts. Apply heat or cold to suspected parts during the warmup period, and you may be able to catch the guilty one in a short time. Don't overlook the controls—height and linearity controls have a nasty habit of developing bad contacts under the sliders if they've been left at

one setting for quite a while. Spray-clean them and work them back and forth several times. END

"Super" degaussing coil?

A standard degaussing coil is 430 turns of No. 20 wire on a 12-inch form. Is there a larger one, more powerful? We need one, I think, for a 23-inch color set that has been hit by lightning.—E. P., Jackson, Miss.

Actually, there's not too much difference in degaussing coils. My own is short of the specified turns (which makes it get just a wee bit hot) but it works just as well as the others, from direct comparison.

Just keep on degaussing until the trouble clears up. Color sets hit by lightning show some peculiar symptoms; mine suddenly developed a bright pink spot about 5 inches in diameter in the center of the screen! However, degaussing for about 3–4 minutes cleared it up.

Look out for troubles in the convergence board. We had another one hit just recently and the convergence board had been damaged. Several ground conductors around the edges just weren't there any more! (PC type board on CTC15.) This upset the convergence just a little (like about 2 inches). So, look for things like that first.

Vertical troubles in CTC12

I've got vertical trouble in an RCA CTC12 color chassis. The vertical linearity isn't right, and there is an intermittent "jump" in the picture; every once in a while it will suddenly drop to about half a raster, then fill out again. Vertical hold is OK.—P. L., Lynchburg, Va.

This is probably due to a slightly dirty or corroded contact between the slider and element on the vertical linearity control itself. Spray it with cleaner, and work it back and forth several times, and recheck. In bad cases, the control will have to be replaced. Check the height control at the same time.

The poor linearity may be due to a loss of capacitance in an electrolytic capacitor, usually the 50- μ f on the cathode of the vertical output.

Permanently magnetized color CRT?

I've got an area of impurity on a color CRT that I can't get rid of. I've demagnetized it, moved the speaker, taken off the rim magnets, and done everything I can think of.

This is a glass tube, a 21CYP22A. In your first letter, you said that you'd

YOU GET PRODUCT PLUS FROM YOUR SYLVANIA DISTRIBUTOR



CONSUMERS' CHOICE

Here's how.

	BRIGHTEST COLOR PICTURE	BEST OVERALL COLOR PERFORMANCE	CLEAREST COLOR PICTURE TO WATCH	BRIGHTEST BLACK AND WHITE PICTURES
Sylvania color bright 85 picture tube	76.1%	66.6%	68.0%	77.7%
Picture Tube A	6.9	9.8	8.9	7.4
Picture Tube B	9.5	13.7	13.4	7.1
Picture Tube C	7.5	9.9	9.7	7.8

Test made under supervision of John J. Henderson and Associates, N. Y. Note: Not all people answered all questions—votes tabulated for 100% of answers to each.

In six major cities from coast to coast, 9,789 consumers compared the new *color bright 85*TM picture tube to ordinary non-rare-earth color tubes in three leading brands of TV sets. Sylvania's new tube, the first with rare-earth phosphors, was the overwhelming choice.

Here's why.

The vivid colors, derived from europium rare-earth compounds, are unexcelled for true color fidelity. In monochrome, the picture is noticeably brighter; there's better contrast too. And today this extraordinary tube is still the performance leader. Sylvania's new air-spun screening process gives *color bright 85* picture tubes the competitive difference in the sharpest images ever displayed.

The *color bright 85* tube is available to you now for today's growing color TV market. It is a product of Sylvania Electronic Tube Division, Electronic Components Group, Seneca Falls, N. Y.

SYLVANIA
SUBSIDIARY OF
GENERAL TELEPHONE & ELECTRONICS **GTE**

Circle 14 on reader's service card

WHY bother with makeshift twist-prong capacitor replacements?

When you substitute capacitor sizes and ratings, you leave yourself wide open for criticism of your work . . . you risk your reputation . . . you stand to lose customers. It just doesn't pay to use makeshifts when it's so easy to get the exact replacement from your Sprague distributor!

Get the right SIZE,
right RATING every time
with improved



**SPRAGUE
TWIST-LOK®
CAPACITORS!**

1,863 different capacitors to choose from!

The industry's most complete selection of twist-prong capacitors, bar none. Greater reliability, too. Exclusive Sprague cover design provides a leak-proof seal which permits capacitors to withstand higher ripple currents.

GET YOUR COPY of Sprague's comprehensive Electrolytic Capacitor Replacement Manual K-107 from your Sprague Distributor, or write Sprague Products Co., 81 Marshall Street, North Adams, Mass.



WORLD'S LARGEST MANUFACTURER OF CAPACITORS

58-126-63 R1

Circle 15 on reader's service card

seen similar cases in the 21AXP22 metal tubes. What could be doing this a glass tube?—W. S., Kirksville, Mo.

After all you've done, there seems to be only one answer: a bad tube! This must be some kind of permanent magnetism in the shadow mask. That's the only thing left!

As you said, when you moved the yoke, then moved the tube itself, the pattern moved with the tube! So, this just has to be something internal. I'm afraid that replacement will be the only answer in this case. Only one thing might offer a possible solution, and this is pretty wild. Try placing a small permanent magnet from a junked PM speaker near the trouble area. Since the area seems to be pretty small, there is just a small chance that you could counteract the distorting magnetic field with something like this. No guarantees on it, though!

Vertical Warmup Roll In CTC5

I've made all of the production changes listed for an RCA CTC5 color chassis, and it still rolls for about 4-5 minutes after it's turned on. If you leave it on, it'll slow down, stop, and then work OK for the rest of the evening! Vertical hold control winds up all the way clockwise.—D. M., Waco, Tex.

This is a typical set of symptoms for a heat-sensitive resistor. Most of them seem to be normal when cold, and change value when hot. This one seems to be off when cold, and back to almost normal when hot!

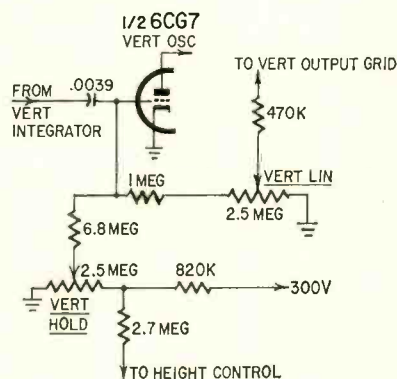

I'd change the 6.8-meg resistor in series with the vertical hold control, since this is the most common cause of such troubles. (Of course, don't accept this as gospel; I ran into one where the resistor was in fine shape and the vertical hold control was drifting!) At any rate, it is some component, and most likely a resistor, in the frequency-determining circuits of the vertical oscillator, that is changing value when hot. Try all of them; apply heat with a soldering iron tip and see if this makes the trouble show up, stop or change. If it does, change that part (and then go on and look for more; there may be more than one!).

END

LEARN THE PROFESSIONAL METHOD OF APPLIANCE REPAIR

For extra income, a job skill
in demand, a business of your
own—or to save money on
your own appliance repairs.

SEND FOR FREE BOOKS

Appliance Division, Dept. 503-016, National Radio Institute
3939 Wisconsin Avenue NW, Washington, D.C. 20016

Send me the illustrated free book that tells about opportunities
in Professional Appliance Servicing and details of NRI's new
course—plus a sample lesson. I understand there is no obligation
and no salesman will call.

Name _____ Age _____

Address _____

City _____ Zone _____ State _____

Accredited Member National Home Study Council

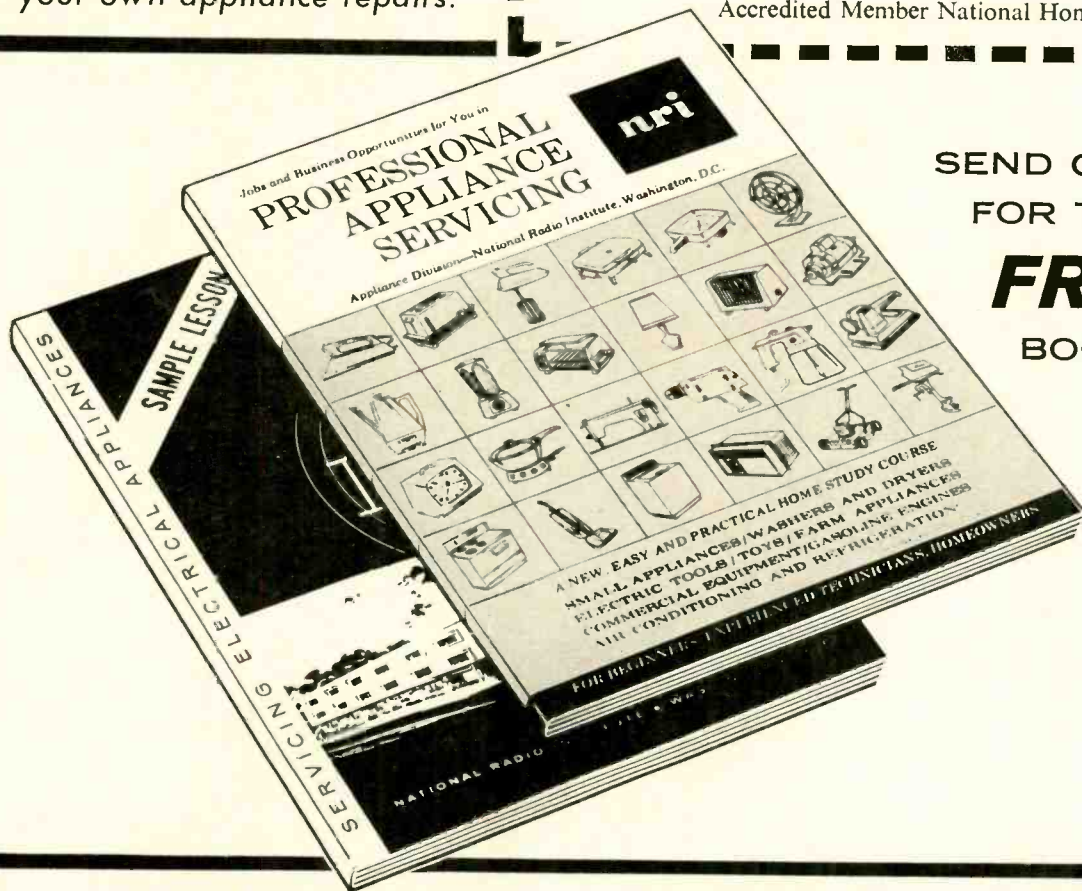

SEND COUPON
FOR THESE
FREE
BOOKS

A new, short, easy course trains you at home

Now you can prepare quickly to do professional
appliance servicing at home in your spare time.

You are ready to start servicing appliances
after only a few lessons. The entire course can be
finished in months.

This is the *fastest* way to a new job skill or
extra income or a business of your own. Wherever you
live or want to live, you'll find a demand for top-notch
appliance servicemen.

There are probably thousands of broken appli-
ances right in your neighborhood. These can mean
cash profits for you.

This new, low cost course covers—

- Small and large home appliances
- Farm and commercial equipment
- Portable electric tools
- Small gasoline engines

—there is even a special course arrangement to
prepare you for the field of air conditioning and
refrigeration.

Special equipment is included in your course at
no extra cost.

Send coupon or write to Dept. 503-016



APPLIANCE DIVISION, NATIONAL RADIO INSTITUTE

3939 Wisconsin Avenue NW, Washington, D.C. 20016

“He’s a good worker.
I’d promote him
right now
if he had
more
education
in electronics.”



NOW! TWO NEW PROGRAMS!

- Industrial Electronics for Automation
- Computer Processing Systems

Could they be talking about you?

You'll miss a lot of opportunities if you try to get along in the electronics industry without an advanced education. Many doors will be closed to you, and no amount of hard work will open them.

But you can build a rewarding career if you supplement your experience with specialized knowledge of one of the key areas of electronics. As a specialist, you will enjoy security, excellent pay, and the kind of future you want for yourself and your family.

Going back to school isn't easy for a man with a full-time job and family obligations. But CREI Home Study Programs make it possible for you to get the additional education you need without attending classes. You study at home, at your own pace, on your own schedule. You study with the assurance that what you learn can be applied to the job immediately.

CREI Programs cover all important areas of electronics including communications, servomechanisms, even spacecraft tracking and control. You're sure to find a program that fits your career objectives.

You're eligible for a CREI Program if you work in electronics and have a high school education. Our FREE book gives complete information. For your copy, airmail postpaid card or write: CREI, Dept. 1401-D, 3224 Sixteenth Street, N.W., Washington, D.C. 20010.



Founded 1927
CREI
Accredited Member
of The National Home Study Council

america's no. 1

LICENSED UNDER ONE OR MORE OF U.S. PATENTS 2,958,081; 2,985,879; 3,011,168; 3,108,280; 3,150,376; 3,210,767; RE. 25,740 AND ADDITIONAL PATENTS PENDING IN U.S.A. AND CANADA. PRODUCED BY JFD ELECTRONICS CORPORATION UNDER EXCLUSIVE LICENSE FROM THE UNIVERSITY OF ILLINOIS FOUNDATION.

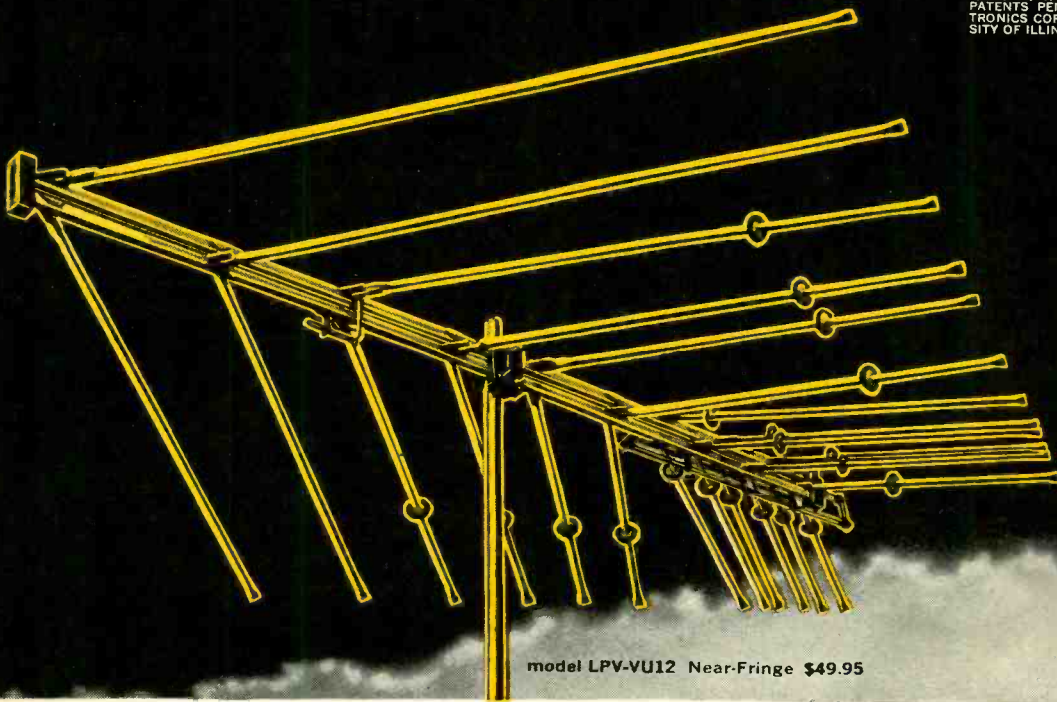

model LPV-VU12 Near-Fringe \$49.95



VHF / UHF / FM ANTENNA!

Because it delivers best 82-channel TV performance—COLOR or black/white—plus FM/Stereo—using only a single downlead!

No other antenna works like the 82-channel JFD LPV-VU Color Log Periodic...

- Only the JFD LPV-VU is designed according to the patented log periodic design of the University of Illinois Antenna Research Laboratories.
- Only the JFD LPV-VU utilizes capacitor-coupled Cap-Electronic dipoles for higher mode operation that achieves higher gain, narrower beamwidths on VHF channels 7 to 13 and UHF channels 14 to 83. (Our competition's copies of the JFD LPV-VU use only fundamental mode which resonate as simple dipoles with consequently limited gain.
- Only the JFD LPV-VU offers true frequency-independent performance that insures brilliant color on any channel.

JFD®

LPV-VU®

Color

LOG PERIODIC

You bet you can have everything you want in one antenna—VHF, UHF, FM—with a single down-lead, too! Start teaming up JFD 82-channel LPV-VU Color Log Periodics with all the 82-channel TV sets in your area—see the difference in profits and performance. Call your distributor or write for brochure 806.

32 million readers of LIFE will be seeing spectacular JFD LPV Color Log Periodic advertisements all season long. This unprecedented LIFE campaign will be pre-selling JFD LPV antennas for you!

Full-color television commercials will show millions more why the LPV's patented space-log periodic design works best on any channel—color & black/white.

6 GREAT MODELS TO CHOOSE FROM



model LPV-VU18
Far-Fringe
\$69.95



model LPV-VU15
Fringe
\$59.95



model LPV-VU12
Near-Fringe
\$49.95



model LPV-VU9
Suburban-Fringe
\$39.50



model LPV-VU6
Metro-Suburban
\$27.50



model LPV-VU5
For City Use
\$25.95

JFD ELECTRONICS CORPORATION

15th Avenue at 62nd Street, Brooklyn, N. Y. 11219
JFD Electronics-Southern Inc., Oxford, North Carolina
JFD International, 64-14 Woodside Ave., Woodside 77, N. Y.
JFD Canada, Ltd.

Circle 18 on reader's service card

DAVID LACHENBRUCH
EDITORIAL DIRECTOR
TELEVISION DIGEST



Color Television 1965-1975

*It has finally become apparent to everyone
that the future of television is in color.*

Guest Editorial by DAVID LACHENBRUCH

IN the first 11 years of commercial color television, the public purchased some 2.4 million color receivers. In the 12th year—1965—the sales for one single year matched the total for all previous years combined.

This signals the end of color's slow-starting introductory period. Manufacturers expect to be selling color sets at the rate of 5 million a year within the next 3 years. Whether sales level off at that plateau or continue to climb will depend entirely on the extent of new technological developments.

Until the present boom, all color sets were very much alike, inside and outside. But when sales began to take off, changes and differences started to show up. In 1964, the first production-model rectangular color tube went to market—the 23-inch version with 92° deflection. This was followed in 1965 by the introduction of the 25- and 19-inch tubes with 90° deflection. The 1966 sets are bringing more new sizes—11-inch, 15-inch, 21- and 22-inch, all rectangular.

The new tubes are the most spectacular of the changes in color since the beginning of the boom. Among other obvious improvements have been the rare-earth phosphors, which increase brightness and improve color rendition, and automatic degaussing, which reduces the need for routine servicing and makes color sets as easily movable as black-and-white.

Perhaps even more significant have been the "invisible improvements" through the years—closer manufacturing tolerances, new receiving tubes, new production methods, hundreds of minor circuit changes—which have meant better

David Lachenbruch has reported on the consumer electronics industry for more than 15 years. After serving in the Signal Corps during World War II as a radio and radar technician, he was a newspaper reporter and editor, and an associate editor of RADIO-ELECTRONICS. He is now editorial director of the industry newsletter, Television Digest. He is the author of the annual TV Set Buyers' Guide, distributed by TV Guide, and of numerous articles on consumer electronics.

performance and lower manufacturing costs. This spectacular upgrading has improved color-set performance and pushed prices down steadily.

Nevertheless, as a *system*, the current color TV receiver and its picture tube are relatively unchanged from the first set introduced in 1954. Few, if any, of the technical improvements can be regarded as truly basic.

How much longer can this "basic" tube and receiver run? Is there room for further significant improvement and price reduction within three-gun shadow-mask tube and set design, or is this the end of the line? Is this the cue for the grand re-entrance of the Apples, Bananas and Chromatrons which long ago were to have revolutionized color TV but somehow didn't?

In the near future, the "dramatic breakthroughs" in color tube and set design seem destined to remain in the lab. The current system, in the view of most industry engineers, can support further improvement and simplification, and this is where the receiver industry is concentrating its energies while striving to fill a seemingly insatiable demand for more, more, more sets.

Within the framework of today's basic receiver system, it's almost a sure bet that the next major change will be in the direction of solid-state. The first phase of the solid-state changeover has already come to black-and-white. In color the pace is slower; only one manufacturer has gone far beyond the tuner in substituting transistors for tubes in color sets.

But solid-state circuitry makes more sense in color television than it does in high-fidelity equipment. Because of its potential for increasing reliability and reducing bulk and heat, the transistor's application to color TV is in advanced stages of development throughout the industry. It undoubtedly will be the next major step forward. The first virtually all-transistor sets will probably show up within a year. Inside 5 years, the changeover to transistor circuits in color should be complete.

Simultaneously with this changeover will come the introduction of still more new versions of the three-gun shadow-mask tube. In 1966, there will be six sizes from 11 inches (diagonal) to 25 inches in 2-inch steps, omitting only 13- and 17-inch sizes—but with a 22-inch size thrown in for good measure. As in black-and-white, color tubes for portable sets probably will evolve fairly rapidly to 110° deflection, while the larger console tubes will hold to the present 90°.

Great ingenuity will be devoted to cutting costs still further, to help bring color within the reach of more of the American public. Some steps in this direction already have been announced in the disclosure of plans for the new 15-inch rectangular color tube. Among its features will be an "Einzel," or unipotential, lens focus system, which makes a separate focus voltage supply unnecessary and permits a relatively low 20-kv anode voltage, specifications suitable either for transistor or series-string tube operation, and eventually a rim-banded faceplate which eliminates the need for bonded or external safety glass, though first models will use conventional construction.

From the standpoint of owners, for years the crying need has been for more color programs. Suddenly this program shortage no longer exists. Probably in one more year, virtually all network TV programs will be in color—and suddenly the shoe will be on the other foot. All programs in color—but

continued on page 94

How We See Color

Read how a curved glass plate coated with tiny, precise dots of three different kinds of phosphor gives you sharp, full-color pictures

By ERIC LESLIE



WHAT MAKES COLOR TELEVISION? Obviously, the picture tube. Yes, special circuitry is needed, too, but it's those color dots on the face plate that make the difference between black-and-white and "living color."

Three things make a color tube different from an ordinary black-and-white picture tube:

The gun assembly, with *three electron guns* instead of one.

The metal *shadow mask*, positioned just behind the screen, and containing over 300,000 holes, one hole for each trio of red, green and blue dots.

The *three-color phosphor-dot viewing screen*, composed of about a million red, green and blue dots.

The beam from each of the three electron guns is modulated by one of the color signals, as well as by a portion of the brightness signals (the brightness signal is applied to the cathode of each gun, color to the grid) and sends electrons out toward the phosphor screen. On their way they pass through the holes of the mask, assuring that the beam of any of the three colors will fall on the dot of the same color. These dots on the phosphor screen, coated onto the back of the face plate of the tube, give us our final picture.

The real action isn't quite as simple

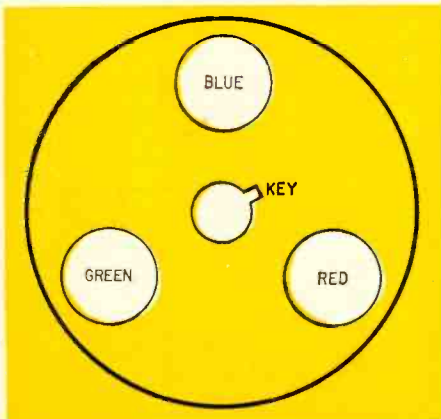
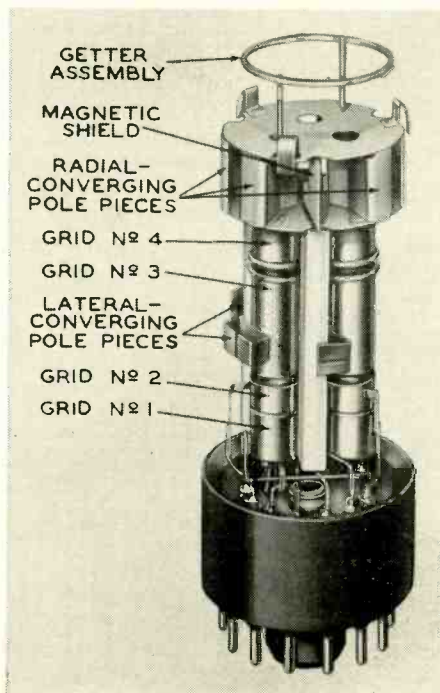

Fig. 1—The three guns are arranged at the vertices of an equilateral triangle.

as that. The beam can—and will—stray from its appointed course unless prevented. Various structures inside the tube, magnets outside it, some windings inside the yoke, and special circuits in the set assure that each beam strikes dots of only its own color. But more of that later.

The three guns are mounted so that their bases form an equilateral triangle.



This view of a color-tube gun assembly, though it shows only two of the guns, shows all the principal parts.

As seen from the rear, the blue gun is at the top, the green gun at lower left, and the red gun at lower right (Fig. 1). The guns are not parallel. The front end of each is tilted a little bit, about 1° toward the center.

The guns are alike. In each, the cylindrical *control grid* (No. 1 grid) is closest to the cathode. As in black-and-white tubes, the control grid cylinder's end is closed except for a small hole at the center for the electron beam.

Each gun has a separate cylindrical screen grid (grid No. 2, see photo), the voltage on that grid can be adjusted by the red, blue or green *screen controls* (depending on which gun is being adjusted). The screen voltages may vary from 130 to 370. The focusing electrodes (grid No. 3) for all three guns are connected.

The last electrode is the *accelerating anode*, composed of three shorter cylinders. The accelerating anode is operated at the *ultor* voltage, usually around 25,000 volts. The pole pieces through which the neck magnets on the outside of the tube concentrate and converge the beams are also attached to the accelerating anode. These magnets and how to position them are explained fully in our articles on converging color sets.

Why convergence?

It is the *convergence* of these beams that makes the difference between a good and a poor color (or black-and-white) picture. If all three beams fall with equal intensity on adjoining dots we have white light. If they stray a little, the color is marred, or color may appear on a black-and-white program.

Convergence comes in two kinds: *static* and *dynamic*. The beams are converged statically (that is, at the center of the screen, with no deflection) by external magnets and the structures in the tubes. Magnets on the neck make it possible to move each beam axially (toward the center or the edge of the tube). Thus the green or the red beam can be moved diagonally, as in Fig. 2, and the blue beam moves up and down.

So it should be possible to focus and aim the three beams so that all fall on the same trio of dots—red, green and blue—on the face of the tube and produce white light. But a look at the drawings shows that while any two of the beams can theoretically be made to cross over each other, the third one's path might pass the other two at some point other than where they converge. Therefore one of them—the blue beam

—has an additional magnet so it can be moved sideways as well as up and down. (Fig. 2, again.) With this extra magnet (the *blue lateral adjustment*), the blue beam can be converged exactly with the other two. The blue lateral adjustment pole pieces are mounted near the center of the focusing electrode.

Now, with the help of the magnets, we can converge the beam so that, at the center of the screen, we have exact convergence. However at the left or right end of the scan, the distance from the electron guns to the face of the tube is a little longer than at the center. Therefore, if nothing else were done, the beams would converge *before* they reached the shadow mask, rather than in one of the holes in the mask, and we would have impure color at the edges of the screen.

To take care of this, *dynamic* convergence circuits supply voltages to the yoke which "pull" the beams to move the point of convergence farther from the gun as the beam sweeps farther from the center of the tube. Thus a properly converged tube shows colors faithfully out to the very edges. Dynamic convergence is more the job of the yoke and the circuitry than of the tube. See the article "Convergence in Basic English" on page 46 of this issue.

The shadow mask

The *mask* is the element that causes the red beam to strike only red dots, the green beam to strike only green dots, etc. (after the beams have been properly converged). As viewed from the tube axis, the center of each hole of the mask is exactly the same distance from the center of each phosphor dot in the color trio just beyond it. As seen from a gun, however, each hole is directly ahead of the dot that is the target of that particular beam (Fig. 3). Thus

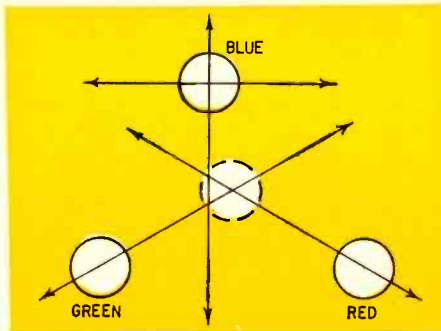

Fig. 2—With small permanent magnets on the neck of the tube, beams can be shifted for perfect static convergence.

when properly converged and lined up, the red beam strikes red dots only, and the blue and green beams reach only dots of their own color.

Drawings and explanations do not always make it clear that the electron beam may not be confined to one hole in the mask. It may be large enough to cover several. Thus a large number of electrons strike the mask between holes, and are drained off as shadow-mask current. This is the basis for one of the criticisms leveled against the shadow-mask tube: that the greater part of the electrical energy is wasted in shadow-mask current rather than used to produce color by striking the screen.

The shadow-mask holes are smaller than the phosphor dots on the plate, thus making it easier to focus a beam on a particular dot. A color screen has been hailed as a triumph of engineering. Each set of color dots has to be laid down in perfect relationship to the other two sets, and so transferred to the face plate of the tube that the dots of one color do not contaminate those of another. (One of the most ingenious tubes, the Trichroscope, or Geer tube, was invented

RCA 15-INCH COLOR TUBE TO USE EINZEL LENS

RCA's new 15-inch rectangular color tube will be the first commercially produced color tube to use the *einzel*, or single-focus, lens, widely used in black-and-white tubes.

The more common (in color tubes) *bipotential* lens focuses the electron beam by accelerating it through an electrostatic field formed by two cylinders, one at 5 kv, the other at 25 kv. The *einzel* lens needs only one high-voltage source. The beam passes through three in-line cylinders. The center one is at ground or low voltage; the end ones are connected together to the final anode voltage.

Because the voltage ratio between *einzel*-lens focus electrodes is essentially infinite, the lens' focal length is insensitive to variations in the high voltage. The receiver is simplified because there is no need for a focus rectifier.

Einzel-lens electron guns give the required maximum beam current at lower screen-grid voltages than those required in earlier designs.

A disadvantage of the lens is that it has greater *aberrations* (distortions in its "optical" field), which must be compensated for elsewhere in the electron-optical system. Also, the nearness of the grounded electrode to the high-voltage electrodes requires extra care in manufacturing.

If the *einzel* lens seems successful in the 15-inch color tube, RCA expects to use it in the 19- and 25-inch tubes.

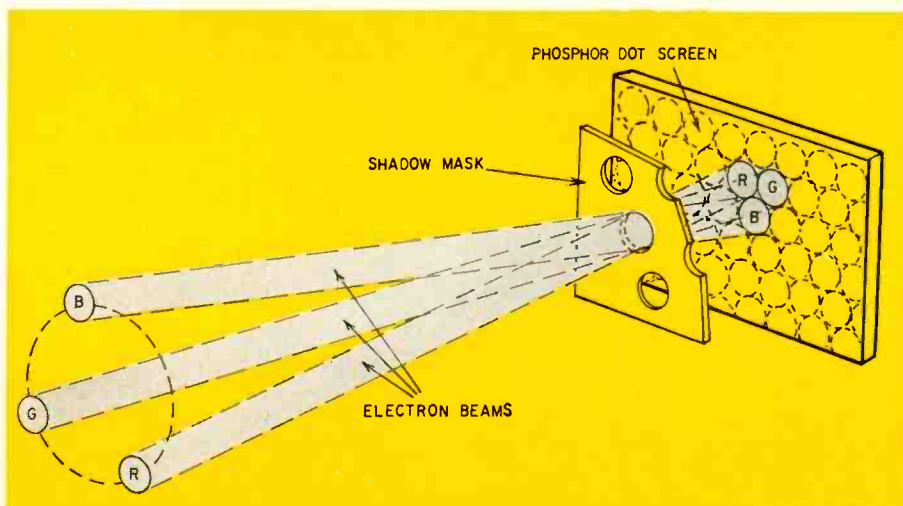

Fig. 3—How the beams converge in a hole in the shadow mask, then diverge just enough to strike the proper dots without overlap.

because of the near impossibility of laying down the three separate colors on the face of the tube.)

Chemical breakthroughs are improving phosphor quality and brightness. Until very recently the green and blue phosphors were much brighter than the red. Therefore the red control was usually run "wide open" and the green and blue adjusted for proper color balance. Recent *europium* compounds have tremendously increased the efficiency of the red phosphor, and therefore the brightness of the tube in general.

There have been numerous attempts to design better color display devices, ranging from the Chromatron, which is finally coming into commercial use, through the Apples and Bananas to tubes using X-rays, and even revolving tubes. But, from the amount of money being invested by the larger companies in plants for manufacturing the shadow-mask tube, it is apparent that the color TV industry does not expect it to be replaced in the near future. END

CHROMA TROUBLE CHART

By JACK DARR SERVICE EDITOR

This chart covers only color-stage troubles. Unless otherwise stated, the black-and-white picture is good, the sound is good, and supply voltages are normal. We've

used the color circuitry of an RCA CTC10 as example, since it has the same basic stages used in all. There will be only minor variations in most other models.

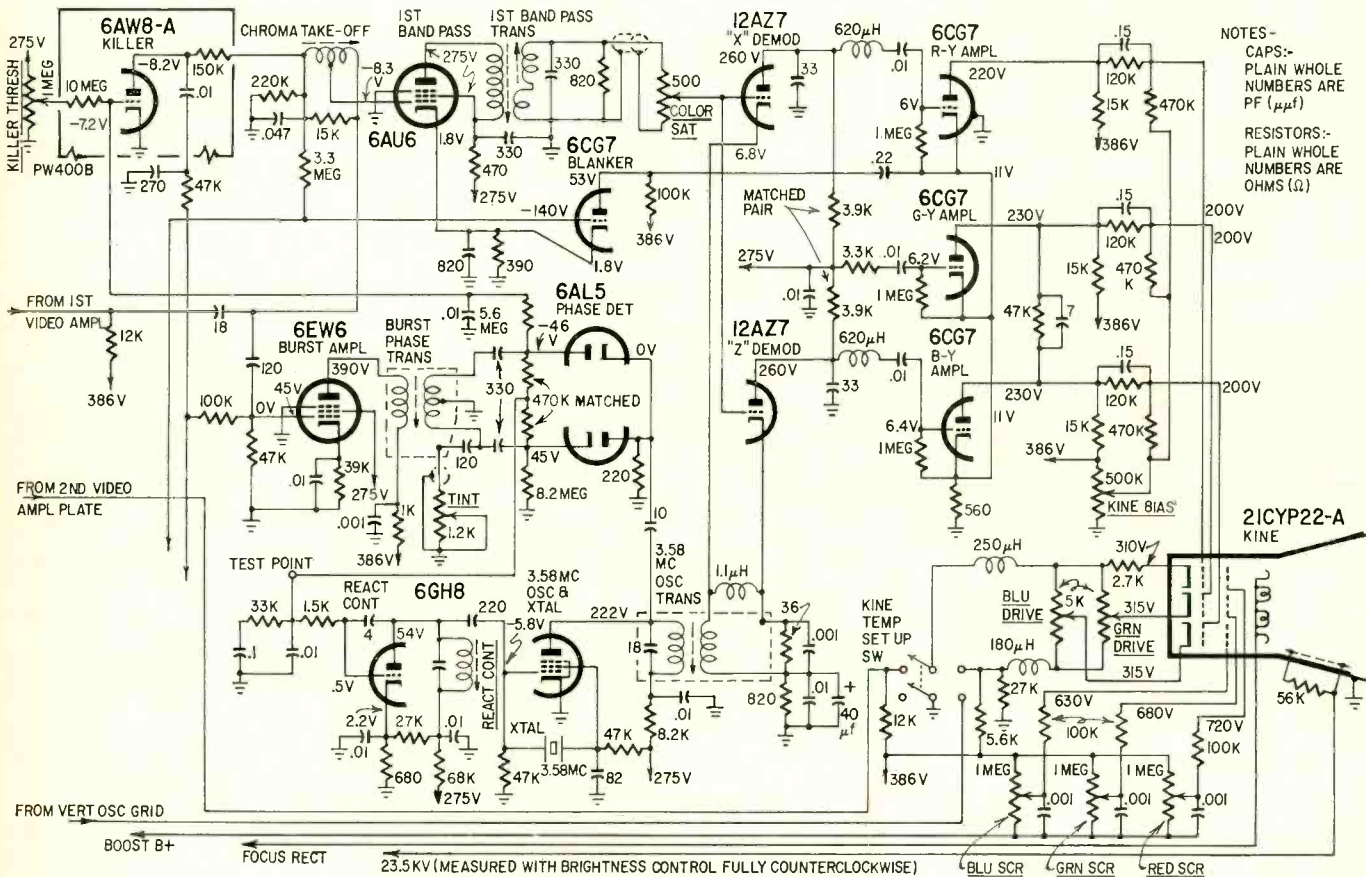

NOTES-
CAPS:-
PLAIN WHOLE
NUMBERS ARE
PF ($\mu\mu\text{f}$)
RESISTORS:-
PLAIN WHOLE
NUMBERS ARE
OHMS (Ω)

NO COLOR AT ALL, BUT GOOD BLACK-AND-WHITE PICTURE

- Check color killer. Control or switch may be turned off.
- Check all tubes, especially band-pass amplifier and color demodulator(s).
- Check all operating voltages: plate, screen, grid and cathode.
- If voltages aren't right in any stage, check parts—resistors and capacitors.
- Check secondary of bandpass transformer for continuity.

WRONG COLORS IN PICTURE

- Check tint (hue) control; must go from purplish to greenish.
- Check fine-tuning setting.
- Check burst-phase transformer adjustments.
- Check 3.58-mc oscillator tube and crystal.
- Check reactance control tube of 3.58-mc oscillator.
- Check 6AL5 tube and color phase detector circuit.

Note: Tint control must be able to make faces go from greenish through reddish to purplish. Normal flesh tones should be near center of range.

COLORS "RUNNING" THROUGH PICTURE. NO COLOR SYNC

Check burst amplifier, phase detector, 3.58-mc oscillator, reactance control and demodulator tubes.

Check 3.58-mc crystal, tint control, burst-phase transformer, and 3.58-mc oscillator transformer.

Check for open or leaky capacitors in burst or 3.58-mc signal paths.

No burst on control circuits at any point? Trace burst through with scope.

WRONG-COLORED RASTER WITH PICTURE (WHOLE SCREEN REDDISH, BLUISH, ETC.)

Note: Since the CRT circuits are all dc-coupled back through the video (Y) circuits and the color amplifier stages, anything that upsets the dc operating voltages of

these stages will change the color temperature of the picture. *The video goes to the CRT cathode, the color signals to the control grids.*

Run full color temperature setup procedure on set *first*, to see if screen or drive control settings have been tampered with.

Check plate, grid and cathode voltages on all three color amplifier tubes, and on CRT control grids.

If any one color is obviously "off", either too much or too little, check that tube and circuits *first*. (Example: picture purple, green is missing.)

Last resort: Check CRT for weak gun.

TOO LITTLE OF ONE COLOR IN PICTURE: CONTROL WILL NOT INCREASE IT

Leaky coupling capacitor in grid circuit of R-Y amplifier, for example, makes bias go too far positive. Plate current rises, plate voltage drops. With dc coupling, bias on CRT increases and corresponding gun's plate current is reduced.

COLORED SNOW IN PICTURE

Color killer not working, check control setting or switch. Also check age setting, antenna, lead-in.

SIGNAL TRACING

Very easy. Put color-bar pattern on screen, use low-capacitance probe on scope, and follow typical "comb" pattern signal through whole circuit to CRT grids. (Set scope sweep at 30 cycles to get comb pattern.)

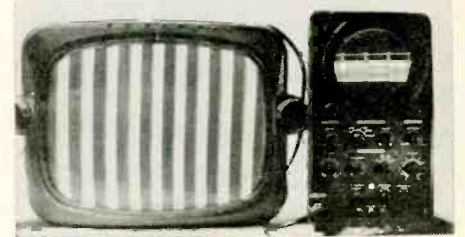

COLOR TUNING RANGE TOO NARROW ON FINE-TUNER

Possible misalignment of adjacent-sound trap in i.f. input. If this is set too near sound carrier, it will cut color carrier down and make tuning very hard. Clue: beats ("worms") in colored areas and very narrow tuning range on colors. Cure: realign with sweep generator.

QUICK CHECK FOR COLOR CIRCUITS

Turn color control full up and tune into "worms". If color circuits are passing signals, you'll see multicolored worms. If color killer is too tight, or color circuits dead, there will be no colors in the worms.

Note: The two problems at left are not in the color circuits themselves, but are often confused with troubles there, so we included them here.

END

HOW TO GET BETTER COLOR

Color TV pictures can be gorgeously lifelike!

Read how to use the panel controls on your set

By MATTHEW MANDL

SURE, COLOR TV DEMANDS A LITTLE more care in adjustment than black-and-white. But color TV, when it's good, is fantastically good—and so, whether you sell it or service it or just watch it, you'll find it's worth a little extra effort to bring the picture in just right. **Don't let anybody tell you that color TV is lousy! It isn't, if the receiver is properly set up.**

Some simple steps will help you to improve the tint and hues. In many cases, you need no test equipment at all. (But once you get good quality, don't expect it to be perfectly consistent. Variations can often occur because of differences in cameras, stations, scenes and a few other things.)

Misadjusted black-and-white controls are one of the most common rea-

sons for poor color reception. Many set owners don't realize how much depends on proper adjustment of contrast, brilliance, and fine tuning. They try to correct color faults by using only the color controls.

well as color pictures. Don't try for super-brightness or you'll get poor focus and a washed-out color picture. Keep the color intensity looking normal, and avoid the color distortion that begins when the color control is set too high. **The fine-tuning control is much more important in color than in black-and-white.** Set improperly, it detunes the local oscillator and shifts the i.f. signal. This decreases color intensity considerably or may cause color dropout. If the fine tuning is too close to the sound carrier, small, wiggly interference lines (Fig. 1) appear in the screen (in black-and-white pictures as well as color, but more noticeable in color).

Set the brightness and contrast controls on a black-and-white picture. Too high contrast may make a harsh black-and-white picture, but on a color picture, too high a contrast setting can subdue color. Advancing the color control to cure this only adds distortion. The proper cure is to lower the contrast setting. Try to hit a happy medium of brightness for both black-and-white as

interference that appears when the fine tuning is off to one side is a good clue for correct setting. Back the control off beyond the point where the interference disappears. This will give you the sharpest picture and the best color. If you advance the fine tuning control too near the other extreme, the picture will be slightly fuzzy, and color will be diminished or even eliminated.

In color transmission, the color carrier is suppressed. At the receiver a 3.58-mc crystal-controlled oscillator generates a carrier for reinsertion so the color signal can be properly demodulated. A sync signal is transmitted to

keep this oscillator synchronized with the program. This consists of about 10 cycles of a 3.58-mc signal riding on the back porch of the horizontal blanking pulse.

When this 3.58-mc burst signal brings the color receiver oscillator into sync, it is also important that the two signals be as nearly in phase as possible. Incorrect phase disturbs the hue (color correctness) when the phase difference reaches approximately 10° .

The hue control (also called **tint control**) adjusts the color phase to produce correct reds, blues, greens, etc. Adjust this control so objects on the screen have a natural appearance. Best results usually come from adjusting the hue control while watching a human face on the screen, and trying for normal flesh tone. But don't expect to be able to set the hue control and forget it. Phase errors will often occur when another camera is switched in or the station switches to a color commercial. Phase may also be upset when you switch to another station.

So, unless you compromise a bit with the hue setting, you may have to readjust it often. Engineers are working on automatic hue control—or at least a hue control that can be regulated from the armchair.

The color control adjusts the degree of color amplification in the receiver. When it is turned all the way down the picture is black-and-white. As the control is advanced, colors first appear as pastel shades and become more vivid as the control is turned further. Adjust the color control for normal-appearing scenes, above the pastel region and below overly vivid color reproduction. The setting of the fine-tuning control has a bearing on this, too. It may be necessary to readjust it when switching to another color station.

Back-of-the-set controls

If you haven't had some experience in color servicing, it's wise not to adjust rear-panel controls or components on the neck of the color tube—if they were adjusted properly when the set was installed, and have not been tampered with since. Front-panel adjustments alone should produce a good color picture.

If you see a pale but uniform tint in the picture during black-and-white reception, there are a few "back" readjustments you can try. The controls are screen and drive, shown in Fig. 2.

Because there is no white phosphor in a color picture tube, the red, blue and green phosphor dots must be made to fluoresce at the proper level to produce white. The controls shown in Fig. 2 regulate the balance, preventing one color from predominating and thus tinting black-and-white reception. **The blue**

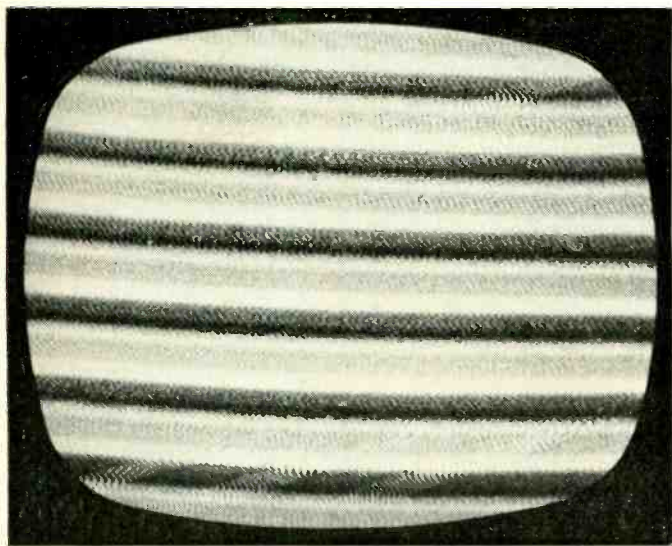

Fig. 1—This kind of grainy interference, shown here on a bar pattern, is a result of setting fine tuning too close to the sound carrier. It looks worse in color, and can spoil the effect of any other adjustments you try.

drive control sets the yellow-blue intensity. The green drive regulates the yellow-green range. The yellow-red range is set by the relative intensities of the other two colors. If the blue and green drive controls are turned down, the red increases (by comparison).

The screen-grid controls regulate electron beam velocity and thus control the brilliancy of the individual colors. During black-and-white reception, the screen-grid controls are adjusted to produce good white highlights in the light portions of the picture, with the brilliance control at normal setting. For low brightness levels, the blue and green drive controls are adjusted slightly to produce black or grey rather than bluish, reddish or sepia lowlights.

The alignment of the three beams in the color tube can be disturbed by magnetic fields around the picture tube face. If brackets and other objects near the tube become slightly magnetized (which can happen as a result of the earth's magnetic field when the set is moved), the fields influence the beam and alter its path slightly. Using household appliances (such as vacuum cleaners, etc.) near the receiver may induce

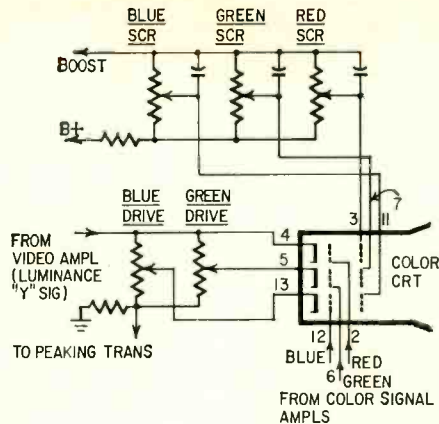

Fig. 2—"Drive" and "screen" controls have a great effect on the background tint of color and black-and-white pictures.

magnetic fields strong enough to magnetize the metal parts near the tube face. This is especially true if the machine is turned on or off while near the receiver. Therefore in some cases it may be advisable to degauss the tube periodically.

Most 1966 receivers have a self-degaussing circuit that demagnetizes the

troublesome area automatically each time the set is turned on. For other receivers, a degaussing coil must be used.

To degauss the color picture tube, the coil is energized and moved slowly around the face of the tube and nearby mounting hardware. The coil is kept energized and slowly withdrawn from the tube face until it is several feet from the face of the receiver. Only then should it be turned off.

What about the antenna?

A poor antenna installation will also make trouble for color. An antenna giving good sharp, ghost-free, noise-free pictures on all channels in black-and-white is essential. Snow and ghosts are more objectionable in color.

Orientation is particularly important. The effects of slight misorientation are much more noticeable in color because of color breakup, or because of interference lines similar to those shown in Fig. 1. If your antenna system has been in use for several years with black-and-white, it might be a good idea to consider a completely new installation (including lead-in) for your new color receiver. END

Electronic Nose Smells Gas

By ERIC LESLIE

"SEEING IS BELIEVING" IS AN OLD SAYING that most of us accept as true without stopping to think about it. "Seeing is smelling" is a new idea developed by Honeywell in a device used to detect concentrations of vapors in dry-cleaning plants at levels far below possible danger points.

The unit is called Per-tector, because the gas it detects is perchloroethylene, commonly used in dry cleaning. With modifications, this "electronic bloodhound" can detect gasoline, paint, lacquer, ammonia, styrene, foam rubber,

tear gas, acids—even ripe apples or bananas. It can measure the number of parts per million of the gas in the air on a meter, as indicated in the photograph, or—more usefully—close a relay that turns on fans when the gas concentration reaches a level that makes more ventilation advisable.

The bloodhound works on the principle that some gases absorb ultraviolet radiation more than others. The unit is shown outside its case in the photograph. A small source of ultraviolet light in the housing at right sends a beam to the phototube at left. When the unit is placed in the case (shown at rear), air is drawn

in by the fan through the perforated grill at the end of the case, to circulate through and out a perforated grill at the other end.

If the air contains perchloroethylene gas, it absorbs more ultraviolet light than ordinary air; thus fewer photons reach the phototube. The change in phototube current is amplified and applied to the meter or a relay or both.

This device is intended to be used in dry-cleaning establishments or industrial plants where it will not receive expert attention. Vapors may deposit on the glass envelopes of the tubes, or dust can accumulate. Thus the instrument might in time become inaccurate. To prevent this, an automatic recalibration circuit is included in the unit.

The long glass tube shown in the photograph contains a standard concentration of perchloroethylene gas. Once every 24 hours it is automatically moved up to the space between the two holes in the upright partition, and the ultraviolet light travels through the known concentration.

A motor-driven potentiometer then adjusts a reference voltage so the meter will read correctly. The tube then drops back into its standby position and the equipment is reasonably accurate for the next 24 hours.

The "bloodhound" will detect concentrations of perchloroethylene as low as 10 parts per million. The relay that turns on the ventilating fans is normally set to operate at a concentration of about 40 parts per million. END

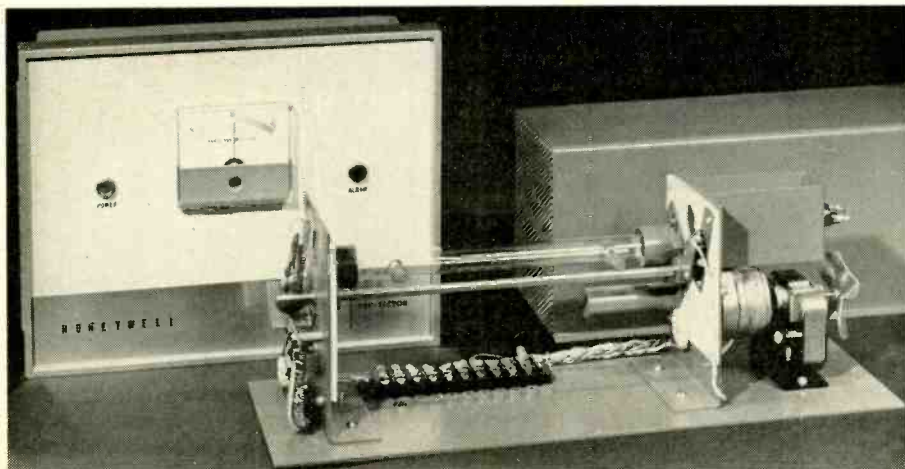

Whatever Became of the Chromatron?

It's still very much around, though not in this country.
An improved version is appearing in Japanese sets

IN THE YEARS SINCE THE SPINNING color-wheel gave way to the three-gun, all-in-one-tube color TV system, quite a few different approaches to color TV have contended for a share in the success of the shadow-mask tube. But, only one fundamentally different color-CRT design shows real promise of commercial success: the "single-gun" Lawrence design, in its two versions, the Chromatron and the Colornetron. (The reason for the quotation marks around "single-gun" will be explained in a moment.)

Before describing the Lawrence type tube in detail, we should note that one reason for the RCA shadow-mask tube's success is that it *worked*, and worked well. It still does, especially with

By **PETER E. SUTHEIM**
ASSOCIATE EDITOR

cluster before passing through the holes in the shadow mask and striking the trio of phosphor dots on the screen. Because of the construction of the tube, a beam cluster properly converged at the center is grossly misconverged everywhere else. So *dynamic convergence* signals tug magnetically at the beams along their axes to shift the point of convergence appropriately. Aside from circuit complexity, this means extra work during manufacture or installation. Every set must be converged individually, a time-consuming operation that calls for a bit of skill and a test generator.

Another problem is that the mask

green stripe, its intensity at that instant is determined by the green signal; as it passes a red stripe, it carries red signal information, and the same way for blue. The switching is done electronically, much in the same way as in a single-beam, multiple-trace oscilloscope. This is known as *time division*.

Making the beam strike only a green stripe when it is green-modulated calls for an additional bit of deflection (aside from the normal vertical and horizontal sweep), because the wires of the post-deflection focusing grid (see drawing) "hide" the blue and green stripes from the beam. It's a little like flicking your fingers this way and that as your arm swings back and forth. The second deflection must be exactly synchronized with the switching of the gun control grid from red to green to blue.

To accomplish this deft trick, the Lawrence tube's grid of vertical wires, parallel to the phosphor stripes and just behind the screen, is fed from a 3.58-mc switching voltage generator. (There are 400 wires, but only four are shown in the drawing. For illustration, they are numbered.) All even-numbered wires are interconnected in a single array, and the odd-numbered wires in another. The complete grid assembly thus has two connections, both fed from a 3.58-mc switching-voltage generator.

When there is no potential on the grid (or, actually, when all the wires are at the *same* potential—at the zero-axis crossing of the 3.58-mc sine wave), the beam shoots undeflected between the wires and strikes a point along a red phosphor stripe. During one half-wave excursion of the sine wave, the charge on the grid wires is such as to make the beam (electrons, remember—negative) deflect toward a green stripe. During the other half-wave, the relative charges are reversed and the beam swings the other way, toward a blue element.

Thus the beam can be modulated sequentially at the cathode with the R, G and B signals, and simultaneously deflected near the screen to the corresponding phosphor stripes.

So much for the raw theory. In actual practice, the grid is fed not only with the switching voltage, but also with a dc voltage about one-third of the anode voltage. The effect of the high dc voltage is to make the grid into an electrostatic lens and accelerator, which focuses the beam and intensifies it.

Note that, with the polarity of the grid unchanged, the beam will be directed oppositely as it passes between

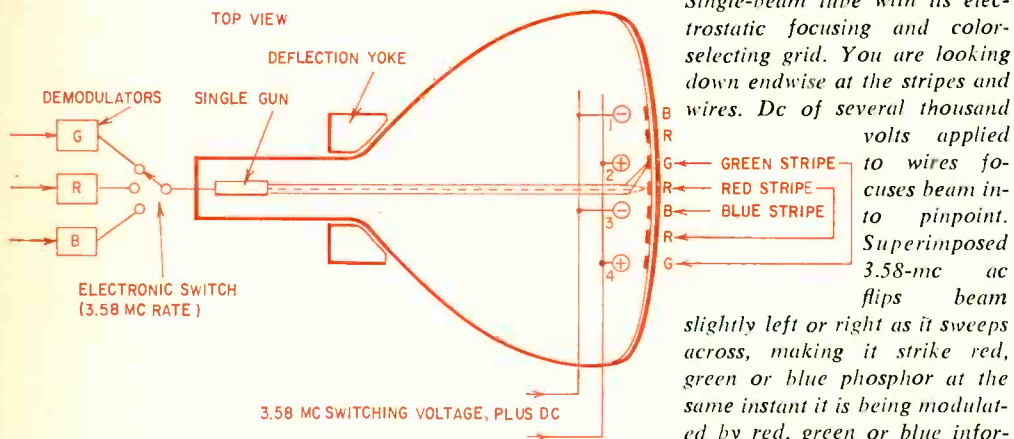

recent improvements. At the moment, it is firmly entrenched in American industry; all US television manufacturers are using it, and not one has announced that it is seriously considering switching to the Lawrence or any other type of tube. The shadow mask tube has definite disadvantages, some of which the Chromatron and similar tubes are said to have overcome. But to become a factor in American color TV, the new type will have to prove itself significantly *better* or significantly *cheaper* than the shadow-mask.

Two principal drawbacks of the shadow-mask tube are the necessity for *convergence*, and the comparatively *low brightness*, a result of inefficient use of the electron beams.

The low brightness can be partially overcome by using brighter phosphors and higher beam currents, but the fact remains that about 85% of the electrons in the shadow-mask tube strike the mask and not the phosphor.

The three independent electron beams must be converged into a precise

itself is easily magnetized by external fields—even as weak as the earth's field, or those created by home appliances. A magnetized area in the mask spoils the aim of the beams and creates pale patches of color in the raster where it should be white. *Automatic degaussing coils*, in all 1966 sets, have eliminated most of this.

Do it with one beam

Naturally, any approach to color-picture-making that uses only one beam will have no convergence problems, since there will be nothing to converge. The nuisance of "gaussed" shadow masks also disappears.

The Lawrence tube was only recently developed for commercial use (though it was invented in 1951). It is now manufactured and used as the *Chromatron* in sets by Sony of Japan. Its phosphors are arranged in parallel, *vertical stripes* instead of in dots. The single gun is modulated *sequentially* with red, green and blue information. The idea is that as the beam passes a

the next adjacent space between wires, because, from the viewpoint of the beam, the positive and negative wires have been interchanged. The result is the sequence of stripes shown, with twice as many red stripes as green or blue.

This can be handled in two ways. One is to make the red gating interval half as long as the others, so that although the red stripes are crossed by the electron beam twice as often as the blue or green stripes, the light output is the same. The other way assumes a less efficient red phosphor (which has been the case until the advent of the "europium reds"). That is simply to let the red phosphor get more than its share of excitation, thereby bringing the red light output nearer the green and blue.

According to Japanese data, the 19-inch rectangular Chromatron tube has 400,000 red, 200,000 green and 200,000 blue picture elements (stripes times scanning lines); about 6% of the 525 scanning lines are lost. By comparison, the 21-inch shadow-mask tube has 350,000 color-dot triangles—that is, 350,000 color elements; but some are unused, lying in the dark space between scanning lines, so that the number of active color elements is roughly equivalent for both types of tubes.

A particular advantage of the Chromatron over the shadow-mask tube is in picture brightness. At least 80% of the beam is effective in the Chromatron, compared to only about 15% in the shadow-mask tube. Still, one gun is not sufficient to excite a large screen; therefore, recent commercial designs of the Chromatron use three electron guns—not in a different principle of operation, but simply to increase available electron current and brightness. So, in a literal sense, the present Chromatron is a *single-beam, three-gun* tube. The picture is 3 times brighter than the picture from a shadow-mask tube, and 70% brighter than that from a single-gun Chromatron, the manufacturer claims.

For black-and-white, the demodulator delivers the same signal voltage to all three outputs. The electronic switch and the second-deflection generator continue to function, but the beam receives the same (monochromatic) information at each "position" of the switch. It thus strikes all phosphor stripes with the same current, producing white light.

The first Chromatron receiver made by Sony has 27 tubes, so it is, if anything, more complex than American shadow-mask designs. Though convergence circuitry is gone, there is now electronic-switching circuitry and a second-deflection generator, which has to put out a fair bit of power. The capacitance



This view of the Colornetron beam-switching tube used in Japanese Yaou sets shows the three high-voltage electrode connections. The center pin is for the focusing grid, which gets 6.3 kv. The outer pins connect with the beam-switching grid, which gets 4.7 kv peak to peak.

of the deflection grid is about .001 μ f, so the generator must push several amperes through that at 3.58 mc to maintain the necessary voltage. Radiation of this switching voltage, and resultant interference, has apparently been overcome in recent designs.

Deflection power (for primary deflection, that is—to the yoke) is much smaller than for the shadow-mask tube—about the same as for a 90° black-and-white set. Ac power requirement for the whole set is about 290 watts.

The Colornetron tube

An offshoot of the Lawrence de-

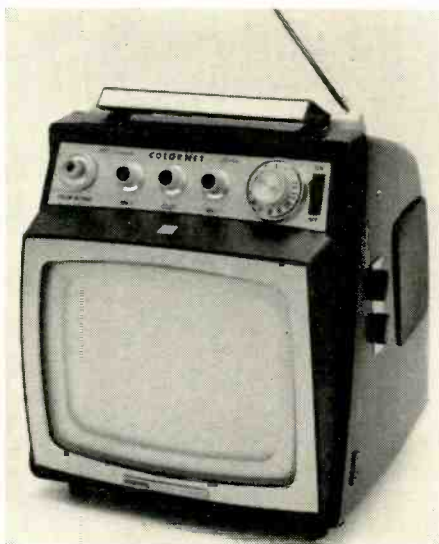

Japanese-built 9-inch all-transistor color portable, which uses Colornetron picture tube.

sign is also being made and used in Japan—made by Kobe Kogyo in Kobe and used by Yaou Electric. It is a 9-inch tube called the *Colornetron*. It works much the same as the Chromatron, but is manufactured differently and has only one gun. At this writing, it is being used in a 9-inch, 90° portable color set. The set is virtually all solid-state; it has 47 transistors, 25 diodes and 6 thermistors. From a 12-volt battery, it draws 22 watts.

The Colornetron differs from the Chromatron designs chiefly in two ways. First, the functions of beam switching and beam focusing are divided between two grids, one behind the other. Second, the phosphors are deposited on a flat, transparent plate which is then installed in the bell of the tube, rather than being deposited directly onto the curved faceplate of the tube. In the photo of the complete set, you can see the comparatively large masked-out area; this is part of tube, not part of the cabinet.

A recently described version of the Colornetron uses a color switching frequency that is described as "very low", although all sources are very silent about what the frequency is (15,750 cycles would seem logical). One charge leveled against the Chromatron is the way it radiates 3.58 mc from its switching grid, though recent designs are said to have overcome that. A lower frequency, such as is apparently being used in the Colornetron, would be one way to solve the problem.

Also noteworthy is the fact that the Yaou receiver, with the Colornetron, uses *offset-subcarrier* demodulation. The offset subcarrier is commonly used in color generators to produce a complete sweep or "rainbow" of colors during each horizontal scan, but has not been used before (commercially, at least) in color receivers. The Yaou set operates with *line sequential* color switching, in which each horizontal scanning line is devoted to producing just one of the three primary colors. Beam switching is done during the horizontal retrace time, so there is no loss of brightness from "wasted moments" during the beam's travel across the screen. The line sequential method has not been popular because of a "crawling" effect in the picture; but the Yaou people claim that this is not visible on the little 9-inch screen.

Information on any of these tubes turned out to be extremely hard to come by. The situation led one of my "sources" to remark that "there must be something wrong with the idea, otherwise there'd be lots of them on the market."

In a future article, we hope to show the actual beam-switching and demodulation circuitry we've been talking about here.

END

ROUNDUP OF 1966 COLOR RECEIVERS

With broadcasters steadily increasing the time devoted to color telecasts, set manufacturers are increasing the number of color receiver models. Many early 1966 sets still use the 70° 21-inch round tube, but the number of sets using the new 11-, 19-, 23- and 25-inch 90° rectangular tubes will increase as tube production is stepped up. The 90° tubes are shorter than the 70° 21-inch round, making it possible for designers to trim 4 to 7 inches off the front-to-back dimension and develop cabinets much more pleasing to the eye—and much more convenient.

Degaussing circuits are widely used by all manufacturers. Most are automatic but some are controlled by a pushbutton on the back of the set.

Circuitry of most 1966 sets is very similar to earlier chassis. A few designers are using compactrons to reduce the number of tubes. Philco has come out with a hybrid chassis that may well set a trend in circuit design. Transistors are used in

the i.f. and agc circuits. If the trend develops, it won't be long before we have all-transistor color sets.

Fine tuning is critical on color sets, so most makers are using tuners with preset fine tuning on each channel. Individual slug-tuned oscillator coils are used. Each slug has a small gear that can be coupled to the fine-tuning control. In some tuners, the gears are engaged by pushing in on the tuning control. Others have gears that are engaged when the fine-tuning control is turned a few degrees in either direction. Magnavox uses afc on both vhf and uhf tuners to handle the fine tuning and to compensate for oscillator drift.

On some new sets you will find tint, color and contrast controls indexed with pointers or slide-rule dials to simplify tuning and enable the viewer to return them to the correct positions for optimum performance. The color fidelity control lets viewer tint black-and-white picture.

Model	Chassis	Pix (in.)	Auto. degauss	Color demod	Color indic	Video peaking	Color fidelity	Preset tuning	Tone	Notes
ADMIRAL TG2200	1G1155-1	21	No	R-Y, B-Y	No	Yes	Yes	Yes	Yes	
TG2211, CG2201, CG2211, LG2201	3G1155-2	21	Yes	R-Y, B-Y	No	Yes	Yes	Yes	Yes	
LG2211, LG2221	2G1156-1	21	Yes	R-Y, B-Y	No	Yes	Yes	Yes	Yes	
LG2231, LG2232, LG2235, LG2241, LG2245	3G1155-2	21	Yes	R-Y, B-Y	No	Yes	Yes	Yes	Yes	
LG2251, LG2251D, LG2281, LG2285, LG2289	2G1157-1	21	Yes	R-Y, B-Y	No	Yes	Yes	Yes	Yes	
SRG2201, SMG2201, SMG2205	3G1155-3	21	Yes	R-Y, B-Y	No	Yes	Yes	Yes	Yes	13
LG5301, LG5305	G1255-4	23	Yes	X & Z	No	Yes	Yes	Yes	Yes	
LG5311, LG5315, LG549, LG5351	G1257-2	23	Yes	X & Z	No	Yes	Yes	Yes	Yes	
LG5511M, LG5515M, LG5619	G1257-2	25	Yes	X & Z	No	Yes	Yes	Yes	Yes	
LG55311M, LG55315M, LG55349, LG55351	G1295-1	23	Yes	X & Z	No	Yes	Yes	Yes	Yes	4, 16
LG55511M, LG55619	G1295-1 5H9N S326AN	25	Yes	X & Z	No	Yes	Yes	Yes	Yes	4, 9, 16
SMG5301, SMG5305, SMG5311	G1255-5 5H9N S326AN	23	Yes	X & Z	No	Yes	Yes	Yes	Yes	9, 13
SMG5611, SMG5619	G1255-5 24A3A	25	Yes	X & Z	No	Yes	Yes	Yes	Yes	9, 13
LG5301W, LG5305W	G1355-2	23	Yes	R-Y, B-Y	No	Yes	Yes	Yes	Yes	9
LG5311W, LG5315W	G1357-1	23	Yes	R-Y, B-Y	No	Yes	Yes	Yes	Yes	4, 9
LG5321W	1G1356-1	23	Yes	R-Y, B-Y	No	Yes	Yes	Yes	Yes	
LG5331W, LG5335W	G1355-2	23	Yes	R-Y, B-Y	No	Yes	Yes	Yes	Yes	
LG5349W, LG5351W, LG5363W	1G1357-1	23	Yes	R-Y, B-Y	No	Yes	Yes	Yes	Yes	4, 9
LG5381W	G1355-2	23	Yes	R-Y, B-Y	No	Yes	Yes	Yes	Yes	
SMG5301W, SMG5305W, SMG5311W, SMG5321W	G1355-3	23	Yes	R-Y, B-Y	No	Yes	Yes	Yes	Yes	9, 13
ANDREA Viking De Vinci Chantilly	VCU-321	21	No	X & Z	No	No	No	Yes	Yes	2

Model	Chassis	Pix (in.)	Auto. degauss	Color demod	Color indic	Video peaking	Color fidelity	Preset tuning	Tone	Notes
Explorer Mercury Norwood Savoy Tivoli Concord Belmont	VCV-321	21	No	X & Z	No	Yes	No	Yes	Yes	1, 2, 3
Imperial Alexis Beauvals Leonardo Montrose	VCV-325	25	Yes	X & Z	No	Yes	No	Yes	Yes	1, 2, 3
CURTIS MATHES	CMC22	25	Yes	X & Z	No	Yes	No		Yes	
DELMONICO CCTV-21	13-122-84U	21	No	X & Z	No	Yes	No	Yes	No	8
DuMONT 51C01 thru 51C19 51K01 thru 51K06	120786-A 120735-C-D	21	Yes	X & Z	No	Yes	Yes	Yes	Yes	2, 8, 10
55K01 thru 55K04	120809	25	Yes	X & Z	No	Yes	Yes	Yes	Yes	2, 8, 9, 10
55C01 thru 55C09	120809	25	Yes	X & Z	No	Yes	Yes	Yes	Yes	8, 9
59P01	120814	19	Yes	X & Z	No	Yes	No	Yes	Yes	9
53C01 thru 53C04	120835	23	Yes	X & Z	No	Yes	Yes	Yes	Yes	9
ELECTROHOME Brighton, Cambridge¹², Talisman, Frontenac, Salem, Lisbon, Canton¹³, Calcutta¹³, Barcelona^{13, 14, 15, 16}, Centurion Color 27, Nantucket, Bonaventure		25	Yes	X & Z	Yes	Yes	No	Yes	Yes	
EMERSON 21C05 to 21C19 21K04 to 21K06	120786-A	21	Yes	X & Z	No	Yes	Yes	Yes	Yes	2, 8 10
25C01 25C02 thru 25C08	120790-A 120809	25	Yes	X & Z	No	Yes	Yes	Yes	Yes	8, 9
25K01 25K02 to 25K04	120790 120809	25	Yes	X & Z	No	Yes	Yes	Yes	Yes	2, 8, 9, 10
23C01 thru 23C03	120835	23	Yes	X & Z	No	Yes	Yes	Yes	Yes	9
29P01	120814	19	Yes	X & Z	No	Yes	No	Yes	Yes	9
23K01	120835	23	Yes	X & Z	No	Yes	Yes	Yes	Yes	2, 9, 10
GENERAL ELECTRIC M920B, M930B, M931B, M932B, M940B, M941B, M942B, M950B, M951B, M952B, M938B	CB	21	Yes (except M920B)	B-Y, R-Y, G-Y	No	Yes	No	Yes	No	20
M960B, M961B, M980B	CB	25	Yes	B-Y, R-Y, G-Y	No	Yes	No	Yes	Yes	19, 20
M919A, M921A, M931A, M933A, M935A, M937A, M939A, M941A, M951A, M953A, M955A, M957A, M961A, M963A, M973A, PAM975A, M977A	CA	21	Yes ²¹ (except 919A & 921A)	X & Z	No	No	No	Yes	Yes	
M213BWD	HB	11	Yes ²²	R-Y, B-Y	No	No	No	No	No	20
HEATH GR-53A		21	No	X & Z	No	No	No	Yes	Yes	1, 23, 24, 25
GR-25		25	Yes	X & Z	No	No	No	Yes	No	1, 9, 23, 24, 25, 26
HOFFMAN FP5004, LP5001, SP5003, W5002		25	Yes		Yes		Yes ²⁸	Yes		27, 29
W5310, W5320, SP5311, MS5322, W5330, SP5331, FP5051, IC5052		25	Yes		Yes		Yes ²⁸	Yes		2, 13, 27, 29
MAGNAVOX	Series 43	21	No	X & Z	No	Yes	No		Yes	1
	Series 45	21	Yes	X & Z	Yes	Yes	Yes ³⁰		Yes	1, 30, 40
	T904	25	Yes	X & Z	Yes	Yes	Yes ³⁰		Yes	1, 9, 40
MOTOROLA 23LK414, -416, -418, 23CL325, -328, 23CD347, -350	ETS-908E	23	Yes ²²	R & B	Yes	Yes	No	Yes	Yes	2, 19, 34
23CL319, 23CL320, 23LK412 ¹³ , 23LK413 ¹³	STS-914	23	Yes ²²	R & B	Yes	Yes	No	Yes	Yes	2, 19

Model	Chassis	Pix (in.)	Auto. degauss	Color demod	Color indic	Video peaking	Color fidelity	Preset tuning	Tone	Notes
25CL250, 25CL251	TS917	25	Yes ²²	R & B	Yes	Yes	No	Yes	Yes	19, 23, 31
23LK414, -417	TS908D, -E	23	Yes ²²	R & B	Yes	Yes	No	Yes	Yes	2, 13, 19, 23, 31
23CU305, -306, 23CS307, 23CT310, -311	TS914	23	Yes ²²	R & B	Yes	Yes	No	Yes	Yes	19, 23
MUNTZ 1210, 1211, 1411, 1412, 1413, 1510 thru 1516		21	Yes					Some models		13 (some models)
3550		23	Yes					Yes	Yes	13, 23
OLYMPIC All models	CTC16, CTC17	21, 23, 25	Yes	X & Z	Yes	No	Yes, on CTC17	Yes	No	2
PANASONIC CT-66		19	Yes	No	No	No	No	Yes	No	32
PACKARD BELL 21CT8, 21CT9	99C1	21	Avail as kit on 21CT8; 21CT9 Yes	X & Z ²	No	No	No	Yes	No	26
25CC4, 25CD1	9BC9	25	Yes	X & Z	No	Yes	No	Yes	Yes	3, 16.1, 19, 23, 26
23CC1, 23CC2	98C10	23	Yes	X & Z	No	Yes	No	Yes	Yes	16.1, 19, 23, 26
25CK1	98C9	25	Yes	X & Z	No	Yes	No	Yes	Yes	13, 16.1, 19, 26
RCA HG-755, HG-759, HG-761, HG-765, FG, HG and GG series	CTC16X	21	Yes	X & Z	No	Yes	No	Yes	Yes	16, 34
GG-288 series	CTC17X	25	Yes	X & Z	No	Yes	No	Yes	Yes	16, 34
SETCHELL-CARLSON 3L6600-25	U802	25	Yes	X & Z	No	Yes	No	Yes	Yes	4, 13, 19, 27, 32, 35, 39
3L66-23, -25	U802	23 or 25	Yes	X & Z	No	Yes	No	Yes ²⁷	Yes	4, 19, 27, 35, 39
3CM66-23	U802	23	Yes	X & Z	No	Yes	No	Yes	Yes	19, 27, 35, 36, 39
3C66-23, -25	U802	23 or 25	Yes	X & Z	No	Yes ²⁷	No	Yes	Yes	19, 35
SYLVANIA	DO2-1, -2, -5, -6	25	Yes	X & Z	No	Yes	No	Yes	Yes	23, 32, 34
	DO3-1, -2	19	Yes	R-Y, B-Y	No	No	No	Yes	Yes	32
TELEFUNKEN			Yes					Yes	Yes	27
WESTINGHOUSE CT6500, CK6530, CK6531, CK6532, CK6533, CK6520, CK6523	V-2488	21	Yes	X & Z	No	No	No	Yes	No	27
CC6150, CC6153	V-2476	21	Yes	X & Z	No	No	No	Yes	No	27, 34

NOTES

- 1—Some models have audio take-off points for external amplifiers.
- 2—Some models use two- and three-way speaker systems
- 3—Remote control available in some models
- 4—Tilt-out control panel
- 5—AM-FM tuner
- 6—FM stereo
- 7—Phonograph
- 8—Similar to CTC16
- 9—Has anti-pincushion circuit
- 10—Combinations with stereo

- 11—Remote speaker switch
- 12—21-inch tube
- 13—Has AM-FM, FM stereo and phonograph
- 14—Remote speakers
- 15—Inputs for tape, phono and auxiliary source, two tape outputs
- 16—Remote control
- 16.1—Convertible to remote control
- 17—Phono or radio can be played through remote speakers while TV is operating

- 18—21K01 to 21K06 are combos with stereo amplifier, A M - F M - multiplex
- 19—Pincushion corrector used in 25-inch chassis
- 20—Magic Memory Tuning. On-off switch volume, tint, color, horizontal hold, vertical hold, brightness and contrast controls have pointers that point straight up when set for best picture and optimum performance. Customer or technician ad-

- justs controls for best performance in the area, pulls off knobs and puts them back on with pointers straight up. Also has preset fine tuning.
- 21—Not available in all models
- 22—A c t u a t e d by switch
- 23—Includes automatic chrome control (acc)
- 24—Kit
- 25—BUILT-IN dot generator for convergence
- 26—Magna - Shield —picture tube is shielded by rectangular "box"

- that protects it from stray magnetic fields
- 27—Instant-on control
- 28—Hoffman calls it "Easy-Vision Cinema Control"
- 29—Color on-off switch
- 30—Sepia on-off switch
- 31—Pushbutton tuning for five uhf channels
- 32—Has earphone jack
- 33—Transistors used in uhf and uhf tuners, three-stage video i.f. amplifier, agc amplifier and video driver

- 34—Some models have AM-FM-stereo tuner and phono
- 35—Unitized construction. Chrome subchassis can be removed for test or servicing and set will continue to produce monochrome pictures
- 36—All controls on side of cabinet
- 37—Unitized construction
- 38—Not used in DO-21 chassis
- 39—Color and hue controls indexed for resetability
- 40—Tuner afc

Model	Chassis	Pix (in.)	Auto. degauss	Color demod	Color indic	Video peaking	Color fidelity	Preset tuning	Tone	Notes
CK7000A, CK7001A, CK7003A	V-2489	23	Yes	X & Z	No	No	No	Yes	No	27
CK7020, CK7022	V-2489	25	Yes	X & Z	No	No	No	Yes	No	27
ZENITH 5302, 5304, 5306	24MC32	21	No	R-Y, B-Y	No	No	No	Yes	Yes	23
5315, 5317, 5319, 5320, 5440	24MC32	21	Yes	R-Y, B-Y	No	No	No	Yes	Yes	23
6306	24MC42	21	No	R-Y, B-Y	No	No	No	Yes	Yes	16, 23
5422, 5424, 5425, 5426, 5427	24NC31	21	Yes	R-Y, B-Y	No	No	No	Yes	Yes	23
7050	24NC31	21	Yes	R-Y, B-Y	No	No	No	Yes	Yes	13, 23
6426, 6427	24NC31	21	Yes	R-Y, B-Y	No	No	No	Yes	Yes	16, 23
8320, 8322, 8324, 8326, 8328, 8341, 8342, 8345	25MC36	25	Yes	R-Y, B-Y	No	Yes	No	Yes	Yes	19, 23, 26, 29
9600, 9610	25MC36	25	Yes	R-Y, B-Y	No	Yes	No	Yes	Yes	13, 19, 23, 26, 29
9341, 9342, 9345, 9351	25MC46	25	Yes	R-Y, B-Y	No	Yes	No	Yes	Yes	16, 19, 23, 26, 29
9510	25MC46	25	Yes	R-Y, B-Y	No	Yes	No	Yes	Yes	13, 16, 19, 23, 26, 29

Improvement for Heath Kit Multiplex Tuner ✓

THE HEATHKIT MODEL AJ-41 AND SIMILAR FM multiplex tuners have a minor problem. The front-panel stereo phase control adjustment is critical and requires frequent attention during warmup to maintain channel separation. A simple modification makes the adjustment very broad and virtually eliminates the need for a front-panel control. The changes are easily made: eight small components are changed or added on the printed-circuit boards and three conductors are rerouted. In the schematic, X's indicate deletions from the original circuit and dotted lines show additions.

In the original circuit, the L-R subcarrier and the 19-kc pilot are routed through V15-a. The stability of the 19-kc oscillator is relatively poor because of the low-amplitude pilot signal, and because of the interaction of the 38-kc signal fed back to the oscillator coil from the 67-kc trap and demodulator circuit. The low-value grid resistor R330 and the cathode degeneration limit the gain of V15-a.

In the changed circuit the L-R signal is taken from the cathode of V13-b and routed to the detector direct. The pilot signal is taken from the plate tuned circuit where it appears considerably amplified. The components of V15-a are changed to assure maximum gain and proper phase shift. The new high-amplitude pilot signal fed to L9 provides a solid phase lock for the oscillator. C334 across L7 must be changed

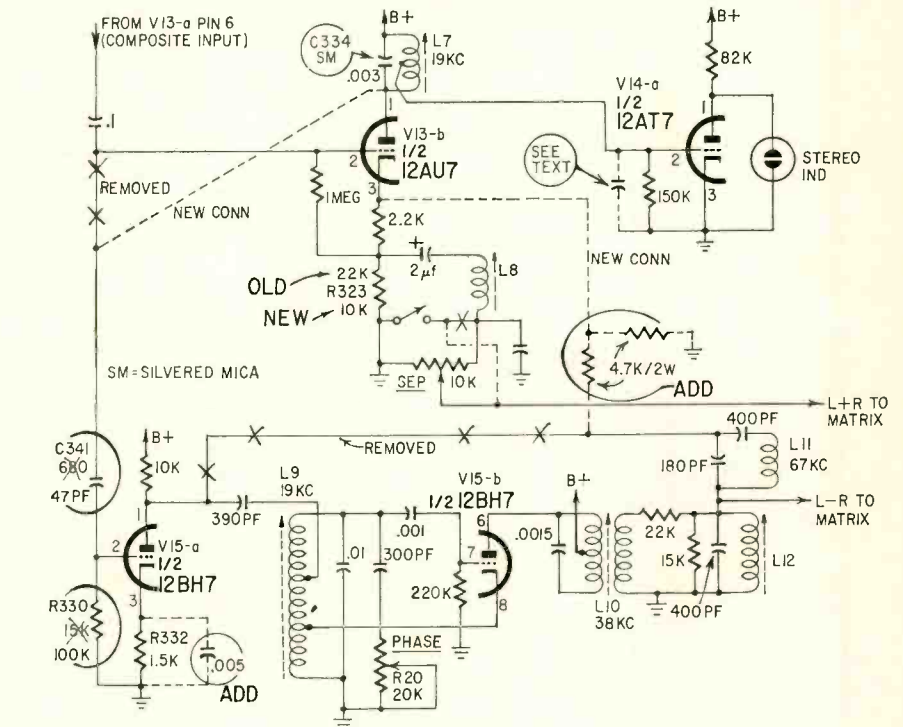

from ceramic to a more stable type, such as silver mica.

Once the changes are made, adjust the circuit: Temporarily remove C341 from the circuit to interrupt the pilot signal. Pull the switch on the phase control to the "adjust phase" position. Set phase control midway. Adjust oscillator coil L9 while listening to a stereo multiplex signal, for near-zero-beat. Connect

C334 and adjust L7 for loudest and best sound. Return the phase-adjust switch to normal. Adjust the separation control for best separation.

In some tuners it may be necessary to add a small capacitor from the V14-a grid to ground. The exact value must be determined experimentally to obtain satisfactory operation of the neon stereo indicator.—Earl T. Hansen

CONVERGENCE IN BASIC ENGLISH

Ever wonder what that control marked "R-G Vertical Differential Tilt" really does? And how it does it? Read on.

By JACK DARR SERVICE EDITOR

A LOT OF BAD LANGUAGE HAS BEEN USED ON COLOR CONVERGENCE. I don't mean what harried technicians say when trying to get 100% convergence on older models; that is neither pertinent nor printable. I mean the long words and fuzzy definitions used in early instruction books, and color TV "courses." Let's go over the convergence process and circuitry, in "basic English" and see if we can't straighten them out.

"Convergence" means coming together—focusing to a point. A color tube has three beams. If the tube had a faceplate shaped like half a ball, it would be easy to focus all three at the same place. They would swing around the deflection center of the yoke, as in Fig. 1. If the beams stayed in the same length, they'd focus at points on an arc. Unfortunately, this'd make a funny-looking tube. The faceplate of a color tube is actually spherical (part of a ball), but the radius of this ball is far longer than the actual beam length from deflection center to screen. If we put the deflection center at the end of the actual faceplate radius, the picture tube would be about 7 feet long! So that's out. We have to do something to make the beams come to focus at the same point, all the way across (and up and down) the screen.

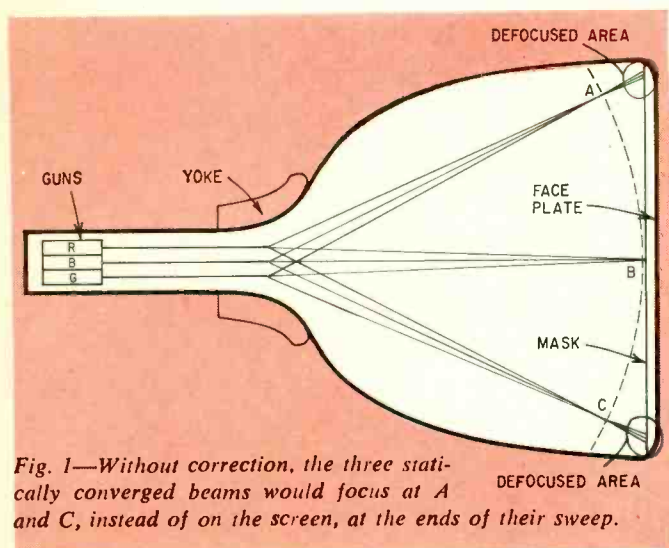

Fig. 1—Without correction, the three statically converged beams would focus at A and C, instead of on the screen, at the ends of their sweep.

If the beams came out of the yoke and hit the middle of the screen, it would be easy. We could focus with permanent magnets; this is *static* or "standing-still" convergence. In fact, this is what we do. But, to get a focused raster all over the screen, we have to *change* focus as we sweep, hori-

zontally and vertically. This is "focus while moving," or *dynamic* convergence.

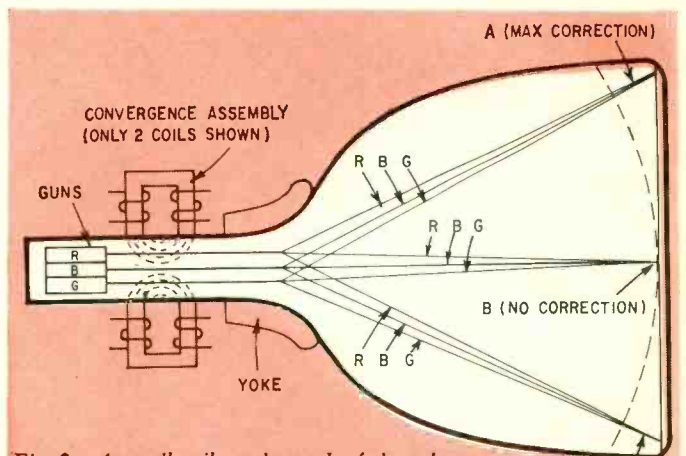

Fig. 2—A small coil on the neck of the tube can alter the focus point of the beam by subjecting the beam to a varying magnetic field. Three coils are used: one each for red, green and blue.

The dynamic action of this circuit is reasonably simple. You know how the deflection yoke works, converting a specially shaped voltage into a specially shaped current, which in turn gives us a specially shaped magnetic field. We do exactly the same thing here.

We've got to do this while the sweeps are in motion. The beam focus must *always* be directly related to the position of the beams on the screen. So, to make our correction, we take voltage pulses from the sweeps themselves, and so make sure that the correction is always in step with the sweeps.

The basic action of this correction is the same for both vertical and horizontal sweep. The curvature of the tube faceplate is the same in both directions, in the round tubes.

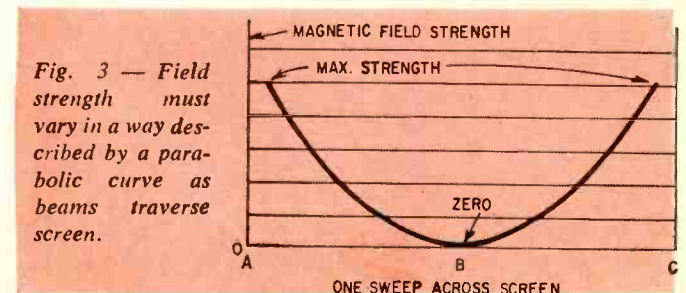

Fig. 3 — Field strength must vary in a way described by a parabolic curve as beams traverse screen.

So, although they act at the same time, we can treat them as if they were separate, at least for this discussion.

To get this correction, we feed the pulses into small coils mounted on the neck of the tube. Each has two windings; you'll see them drawn as if they were on separate legs of the iron core. In actual practice, they're on the same leg, in case you were wondering. One winding is for vertical and the other for horizontal corrections. One coil is mounted over each gun. Small permanent magnets are on the back of each, although they have nothing to do with the dynamic convergence: they are the static adjustments. By the combined action of the magnets and coils, we get a true "moving focus" (dynamic convergence) and the beams hit the right holes in the mask all the way across (Fig. 2).

Starting at rest, in the center of the screen, we can focus with permanent magnets. This is "zero dynamic correction." If we swing the beam to either side, or up and down, it goes off focus. As Fig. 2 shows, we have to push the focal point farther away. This means the magnetic field in the coils must be stronger—more current through the correcting coils. Since we do have a uniform curve to the screen, we can use the same basic correcting waveform.

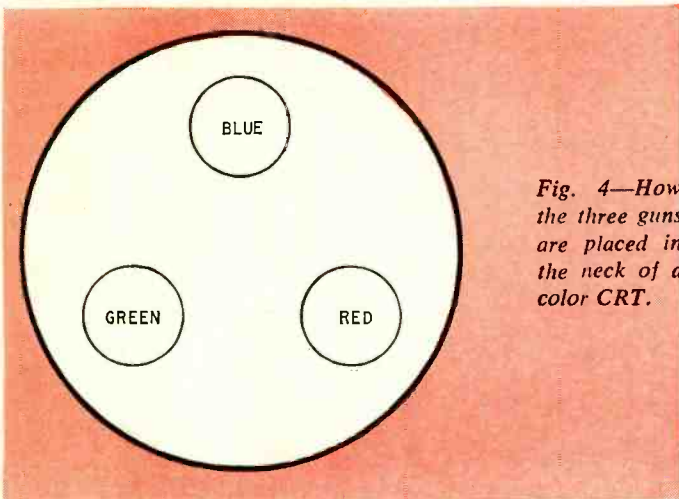

Fig. 4—How the three guns are placed in the neck of a color CRT.

We begin with the beam at center. Zero correction needed. Moving to one side, we need more magnetic field, to push the focus farther away. We can represent the field strength with a curve which is zero in the center and rises to a maximum in both directions (Fig. 3).

THE CONTROL THAT ADJUSTS . . .	IS CALLED . . .
1 Red-Green vertical lines, bottom.	R-G Vertical Amplitude
2 R-G vertical lines, top.	R-G Vertical Tilt
3 R-G horizontal lines, bottom	R-G Vertical Differential Amplitude
4 R-G horizontal lines, top	R-G Vertical Differential Tilt
5 Blue horizontal lines, top or bottom	Blue Vertical Amplitude
6 Blue horizontal lines, top or bottom	Blue Vertical Tilt
7 R-G vertical lines, right side	R-G Horizontal Amplitude
8. R-G horizontal lines, left side	R-G Horizontal Master Tilt
9 Horizontal blue, center screen	Blue Master Tilt
10 Horizontal blue, center screen	Blue Master Amplitude

How can we get this? By feeding a properly shaped voltage waveform into an inductance. As in the deflection yoke, we feed in a shaped voltage and get the desired current waveform. In case anyone was wondering, the magnetic field in such a coil is almost exactly the same as the current wave through it; so, when we say current, we can also mean the magnetic field "waveshape" as well.

This waveform has to be completely *controllable*, in size and shape, so that we can adjust it to give the right amount of

Fig. 5—Sawtooth from vertical amplifier, properly shaped and passed through convergence coil inductance, makes parabolic current and field.

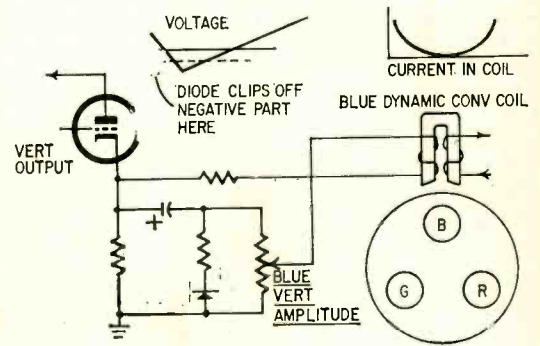

correction at any point on the screen. Let's see how we can do so.

We have three guns: red, green and blue. They are set in the tube as in Fig. 4: blue on top, and red and green side by side below. This works out very nicely. The first color sets used separate corrections for all three. Now, we can use one for blue alone, and correct red and green together with another.

Horizontal and vertical corrections use exactly the same kind of fields and currents. The only difference is in the frequency. So, our basic process will apply to either. Let's begin with the vertical.

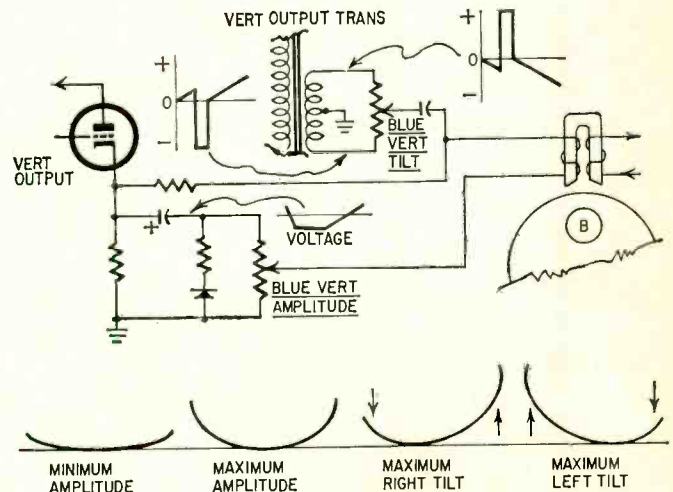

Fig. 6—Adding an adjustable pulse from the vertical output transformer secondary lets us tilt the parabolic current by changing the phase and polarity of the added pulse.

To make the current, we need a special-shape voltage sawtooth. We can pick one up at the cathode of the vertical output tube (Fig. 5).

If the coil were one of those ideal inductances found in textbooks, a true *parabolic* (the shape we need) current would flow. Since it isn't, we have to *shape* the sawtooth. The diode and resistor do that, by clipping the peak.

We need to control the strength of the magnetic field.

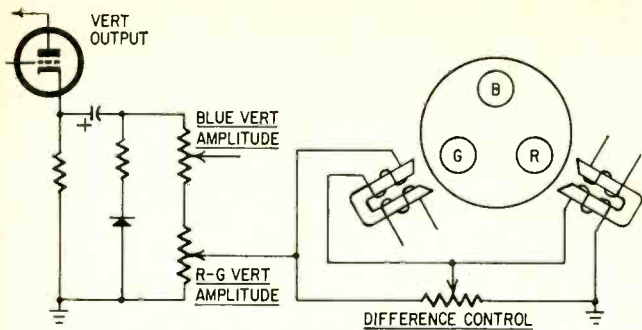

Fig. 7—Difference control allots a portion of the waveform to each coil.

So we add a simple potentiometer across the sawtooth voltage source. Now, we may have a little odd variation in local conditions, and so need to “push” farther at one end of a sweep than at the other. So, we need control over the waveshape, too.

We get this by adding another waveform at the vertical frequency. This comes from the vertical output transformer, from a special secondary winding as in Fig. 6. This is fed in series with the first sawtooth. Its basic waveform is a spiked sawtooth since that’s what we have in the vertical output transformer. We need a control on this; so we ground the center tap of the secondary and put a potentiometer across the whole winding. Now we can get positive-going or negative-going pulses, just by setting the control.

What does this do? By adding more or less negative or positive pulse, we can change the waveform of the current as shown in Fig. 6. We can “lift” one end or the other (make one end have more amplitude, while lowering the other end). We call this *tilt*, since we are actually tilting the waveform plot around the center, which remains at zero.

Now, there are your two *basic* convergence controls. *Amplitude*, which determines the strength of the magnetic field, and *tilt*, which determines the waveform. You’ll find these controls in every circuit. If you know how one works, you’ve got ‘em all!

Figs. 5 and 6 show only the blue: a single circuit. Now, let’s see how the same things can be used on two guns at once. Since the red and green guns are side by side, we can use the same correction on both at once, by simply hooking the coils in series between an amplitude control and

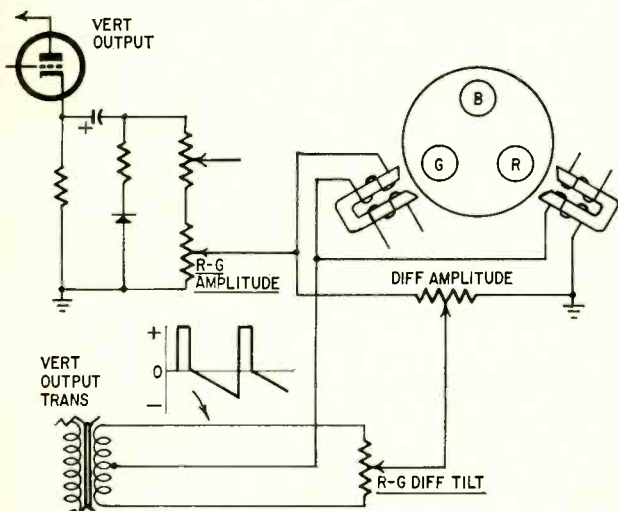

Fig. 8—Same basic tilt circuit as was used for blue applies to red and green. Another difference (proportioning) control is used here.

ground. The current is the same in both coils. Now we’re correcting red and green at the same time.

Ideally, this works; practically, we’ll need a way to make individual corrections to one or the other. So, we add a control which can change the amplitude of the current in the two coils (Fig. 7). This is connected to make the current in one go up while the other goes down. It’s called the “difference” or *differential amplitude control*. Now we can balance the two, if we have to.

Same waveform problems as in the blue; so we feed in correcting waveforms from *another* secondary on the vertical output transformer. Fig. 8 shows this, and the control used to vary the waveform for tilt action. This, too, has the same “difference” effect—one up and the other down—so this is a *differential tilt control*.

Now, let’s put ‘em all together and see what the result looks like. A mess, isn’t it? But, just remember that it’s nothing but the simple circuits we’ve been looking at, all tied together. Note that the blue and red-green vertical amplitude controls are simply hooked in series across the vertical output tube’s cathode; since we use the same waveform, we can do this. The separate secondaries on the vertical output transformer keep one adjustment from upsetting another. One more control has been added: a red-green differential tilt, across the blue-tilt secondary (Fig. 9).

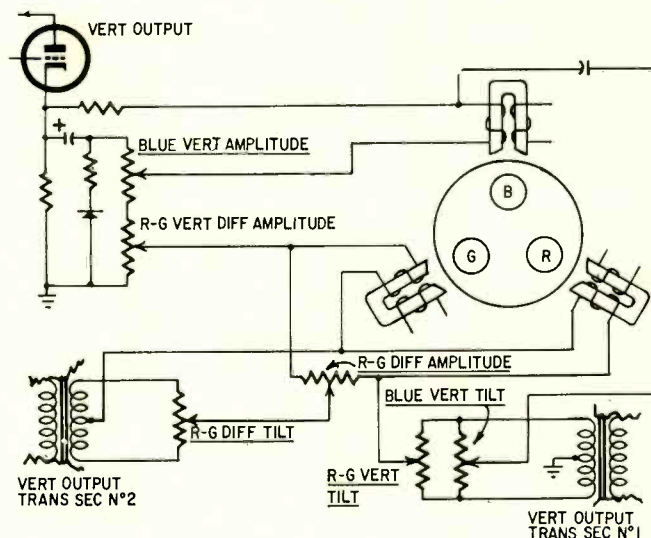

Fig. 9—Complete vertical dynamic convergence circuit. Note that two separate secondaries are used on the vertical output transformer. R-G differential tilt control varies relative amounts of tilt wave to red and green coils.

Horizontal correction

We make horizontal corrections in exactly the same way; amplitude and tilt controls are used. Because of the higher frequency, you’ll find different kinds of parts. Remember that the principles are still the same, and so are the waveforms.

Fig. 10 shows the red-green circuit, with amplitude and tilt controls. Amplitude is controlled by putting an adjustable coil in series with a high-voltage pulse from the fly-back (about 250–300 volts peak to peak). The L-C network makes it into the right shape, roughly a sawtooth. This control converges the vertical red and green lines on the right half of the screen. The diode and resistor combination helps in the shaping, and also causes a very small direct current to flow through the coils, which helps to hold center convergence when dynamic adjustments are made.

Red and green coils are connected in parallel; we're feeding the same waveform to both of them, just as before.

The variable resistor in the shaper circuit is used to add or subtract various amounts of the capacitance of C; this controls the waveshape. (The output waveform of an integrator circuit, which this is, is determined by the product of L to C, or R to C, if it's an R-C integrator.) So, we can use this for a tilt control. This control converges red and green vertical lines on the left half of the screen.

Individual adjustments for each gun are still needed; we make them by feeding in two smaller pulses, of opposite polarities, at the other ends of the coils. A dual control is used; the sliders connect to red and green coils as shown. This too is a difference control; as one goes up the other goes down; this is the *red-green differential tilt*. The positive pulse comes from a separate winding on the flyback, not shown.

Now we need a blue correction. Because of the single coil's position on the tube, we can use a simpler correction for it. The 30-volt positive-going pulse from the flyback goes to the shaping network.

There are two adjustable L-C networks in parallel. One, the *HORIZ BLUE TILT*, is used as an amplitude control. The *HORIZ MASTER AMPLITUDE* (center phase control) removes the droop in the middle of the blue lines.

Now, we have controls for everything: waveform, phase, tilt and so on. These controls are designed to have their greatest effect at different points along the parabolic waveform, or the sweep, whichever you want to call it. So, the visible effect shows up at different places on the screen. At last, we're getting controls with such practical labels as "red-green horizontal lines, bottom of screen" instead of abstractions like "red-green vertical differential amplitude control." This tells a technician a heck of a lot more about what

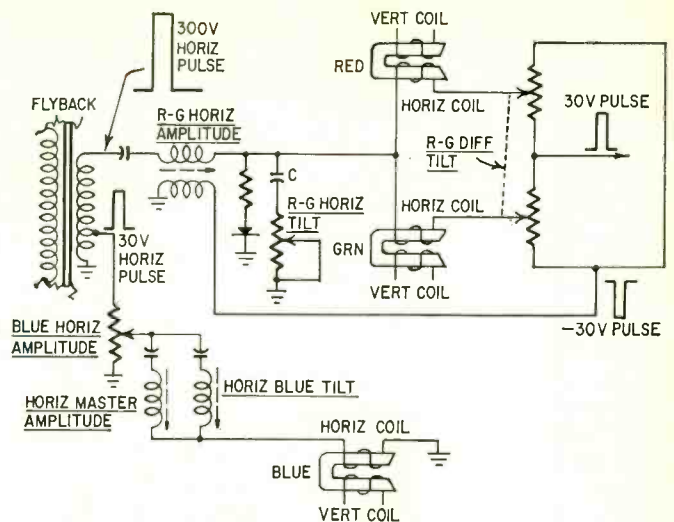

Fig. 10—Horizontal dynamic convergence: same basic method as before. High-voltage pulse from flyback is shaped into sawtooth. Adjustable coil is amplitude control; variable resistor controls tilt. Differential tilt is done by adding low-voltage positive or negative pulses.

the control is supposed to do, and makes the job a lot easier. It's a very good idea to know what each control is, but more important to know what it *does*. I like this latest method of naming controls a lot better!

A little table with this article lists the purpose of each control, and its name, for reference. Three cheers for the Red, Green and Blue!

END

SELF-CONTAINED IN-THE-EAR HEARING AID USES MICROCIRCUIT

A new, completely self contained integrated-circuit hearing aid fits in the ear almost as inconspicuously as a contact lens fits in the eye. Weighing less than 1/4 ounce *with its battery*, the aid (called Solitaire) was developed by Zenith Radio Corp.

The integrated circuit which forms the nucleus of the tiny hearing aid does the jobs of 6 transistors and 16 resistors; yet it's so small that the complete aid (about the size of a quarter, though not round) contains a magnetic microphone,



a telephone pickup coil, an output transducer, a volume control and an on-off-microphone-telecoil switch (as well as the battery).

The full name of the amplifying chip (and it is just a chip) is a *silicon planar epitaxial monolithic integrated functional electronic block for low-level audio application*. That name, if you can get through the Latin and Greek, describes

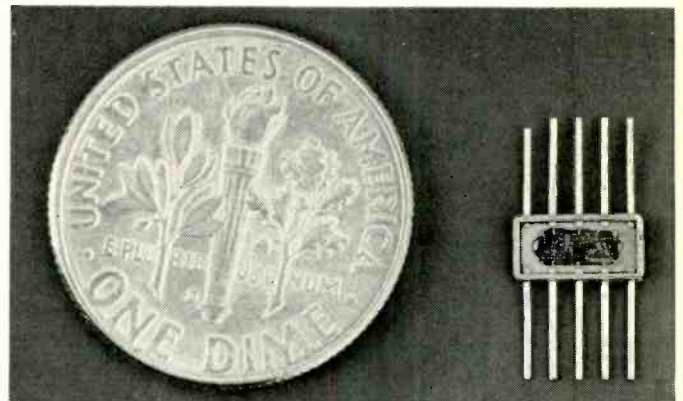

it pretty well. The monolithic (one-piece) silicon chip measures .065 by 0.150 by .007 inch. The resistors, conductors and semiconductors are created in and on the chip by a process of masking and etching (not unlike the steps used in printed-circuit manufacture, only on a fantastically smaller scale), diffusion with vapors of "doping" elements, oxidation, re-masking and re-etching, and so forth.

The circuit is a single-ended class-A amplifier, and draws only 2 ma from a 1.55-volt silver-oxide battery.

CORRECTION

A typographical mix-up destroys the sense of the first part of the article "Do You Understand What You Read on Your Meter?" on page 46, November 1965. The text beginning with the fifth paragraph in the first column ("I hooked up the bias box . . .") and ending with the ninth line of the second column (. . . overloaded completely.") should be inserted between the eleventh and twelfth lines in the third column on page 46.

REPAIRING RECORD CHANGERS

This second half of the story details speed troubles and some adjustments you can make

By HOMER L. DAVIDSON

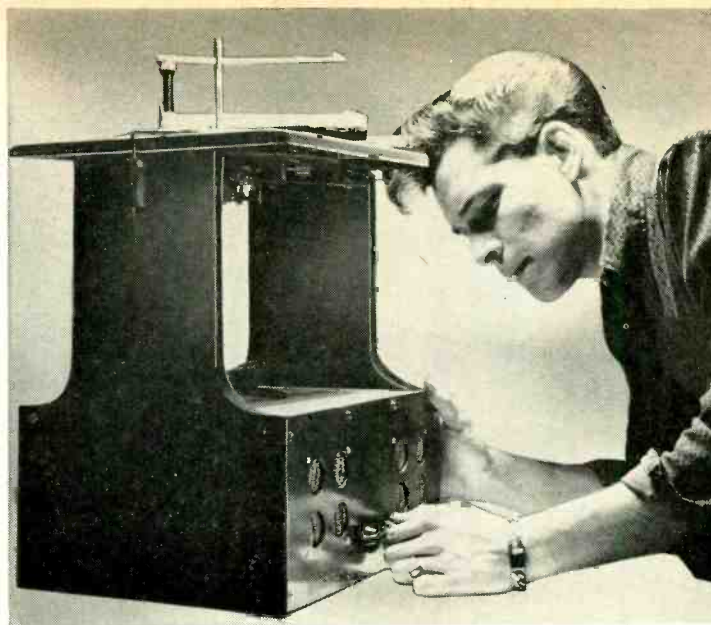

ONE OF THE MOST FREQUENT RECORD changer complaints is about speed: "My changer runs too slow" or "My changer plays one record and then slows down and stops." Trouble like that can be caused by slippage (too little friction where it's needed), dry bearings (too much friction, where it isn't) or a defective motor.

Take a look at the motor assembly (Fig. 1). The ac motor turns the idler wheel and turntable. (Most of these changer motors are ac, and only a few are ac-dc types.)

A burned-out motor is easy to spot. The field winding will be charred and you will smell "burned transformer". The whole motor assembly must be re-

placed after a few hours in operation. This is normal.

Misalignment between motor shafts and bearings will freeze them together. A fine cutting oil can be used to loosen up the shaft bearings. If the motor is full of dirt and grease, take it apart. Clean the bearings, armature and assembly with cleaning fluid. Mark one side of the motor field assembly so you will know which side goes next to the mounting frame. The sides of the field assembly look the same and it is very easy to reverse it when the motor is completely apart. If the field assembly is turned over, the motor will run backward. Oil the motor bearing felts with light machine oil. If the changer motor

cause too much trouble. If it is properly cleaned and greased when the changer is in for repair, it will last for a long time.

The speed of a changer turntable must be checked with some type of speed indicator. Use a strobe disc and light to check for correct speed (Fig. 2). These discs can be picked up at the local wholesale house. A fluorescent or neon light will show if the turntable is running at the correct speed. Fig. 3 shows a strobe light you can build. (Several firms supply small neon strobe lamps with their strobe discs.) Most record changers run slow, almost never too fast.

If the large turntable drive idler wheel is dented or a piece of the rubber is dug out of it, the turntable will thump when this spot comes around. The rubber on these wheels becomes worn, smooth and cracked. Replace the wheel if it looks defective. If the tension spring from idler wheel assembly to the base is loose, tighten it. A couple of turns can be snipped off and the spring fastened back into its original position.

The turntable may be slow for 33 $\frac{1}{3}$ rpm and OK on all other speeds. If this is the case, check the 33 $\frac{1}{3}$ idler wheel. Many times shafts become dry or the rubber smooth, reducing the speed. Pull off all three rubber wheels and clean them thoroughly. Use a match or toothpick and place a small amount of petroleum jelly inside the bearing. Do not use too much grease; it will cause slippage. (Many times a customer will oil everything under the turntable to try to gain speed.) Be careful that no oil or grease gets on the turntable drive, rubber idler drives or motor drive shaft.

One of the biggest causes of slow speed is the slipping of the idler wheel on the drive rim of the turntable. Clean the drive rim and use a turntable dressing such as Phono-Magic. This dressing will dry rapidly when the turntable is placed under a shop light. Fig. 4 shows

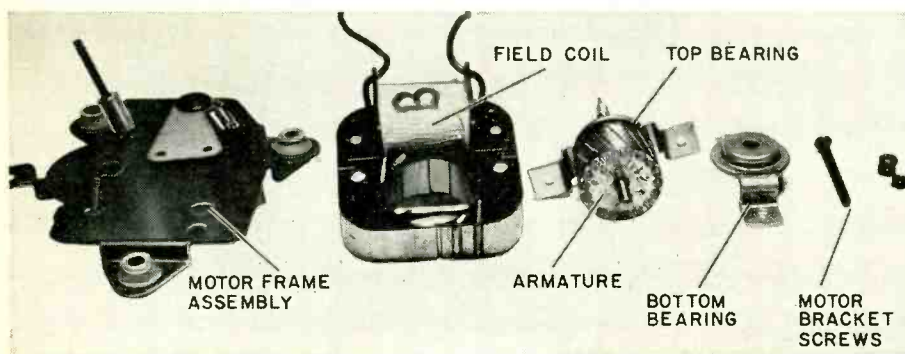

Fig. 1—Major motor parts.

placed. If the motor has a shorted field, it and the whole motor will become very warm in a few minutes.

Even new motors can have stuck or tight bearings. If the motor and turntable have been completely greased within the last month, and the customer complains that the turntable does not rotate, the motor is stuck again and should be replaced.

Field-coil resistance ratings are not usually available from manufacturers. Of course, if an ohmmeter check shows that the field coil is open, the motor is defective. Most motors do run warm

in a small tight compartment, use petroleum jelly as lubrication.

The motor bearing may loosen in the bolted assembly. Sometimes the whole bearing assembly drops down, jamming the motor. A noisy motor indicates lack of oil or really bad bearings.

If there is too much play in the bearings, replace the whole motor assembly. A motor will freeze when the changer jams in operation and is left on, or when the worn rubber drive wheel jams between motor and turntable. The phono motor, though, generally doesn't

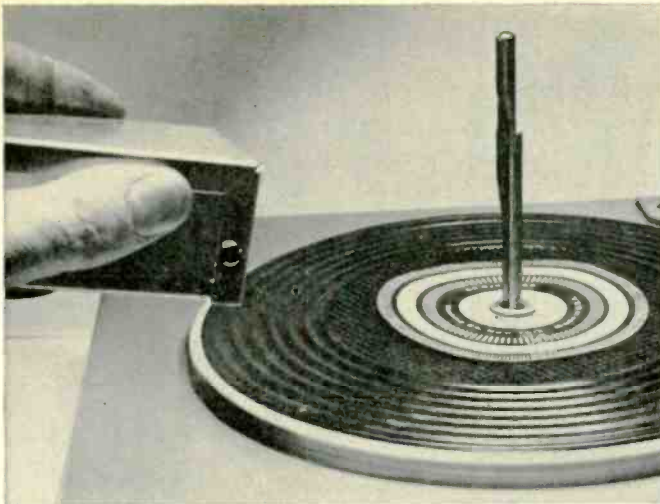

Fig. 2—Simple cardboard stroboscopic disc, viewed under 60-cycle neon light source, gives accurate check of speed.

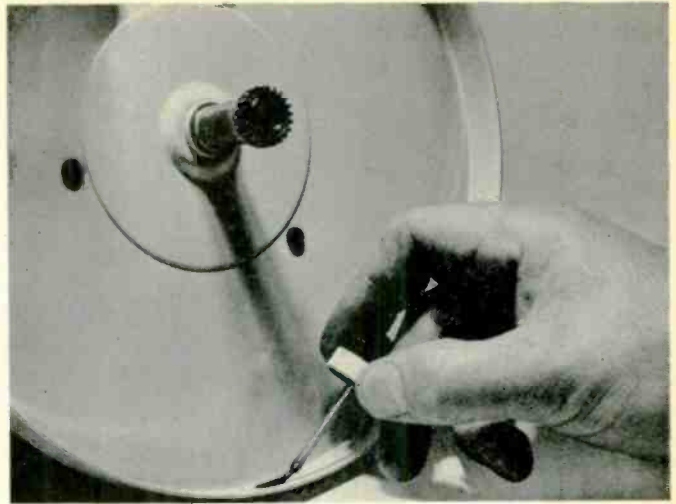

Fig. 4—Friction dressing applied to turntable's inside rim often cures slippage and slow speed.

how to apply dressing to the turntable. If the changer is old and you cannot get the speed up to normal as described so far, take a small spring, a little larger in diameter than the spring on the motor drive spindle, and install it over the old one. File and smooth down any rough ends and, generally, the changer will run a little faster than before. Fig. 5 shows a defective rubber cam drive on an older type of changer. Idler wheels and parts are available at local radio and TV parts distributors or wholesale set distributors.

Adjustments

The landing position of the pickup arm is adjusted with a screw (Fig. 6). It should be set for all three record sizes. Some changers have a hole for this in the top of the turntable base and also on the pickup arm assembly. Make

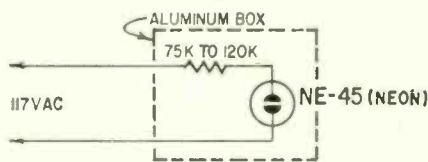

Fig. 3—Hand strobe light source is neon lamp powered from ac line through current-limiting resistor.

the setting so the stylus falls on the record midway between the outer edge and the beginning of the recorded portion.

Rotate the turntable until the pickup arm is at its highest position. Set the height adjustment screw so there is enough clearance under the next record to drop and enough also above the height of a ten-record stack on the

turntable. Some manufacturers provide two height adjustments, to prevent the needle from landing on the motor board out of cycle, and still let it land properly on a stack of records. Most height adjustment screws are located under the pickup arm and between the lift pins. Some changers have a pickup arm tracking force adjustment—a tension spring in the arm itself.

Check the stylus for wear and chipping. Be careful when replacing a needle in a crystal cartridge—crystals are easily damaged. A defective crystal cartridge will have no sound, distorted sound or intermittent sound.

Some service technicians set the changer on ordinary paint cans for repair. The photo at the head of this article shows a homemade stand with a self-contained amplifier for checking out the repaired record changer. **END**

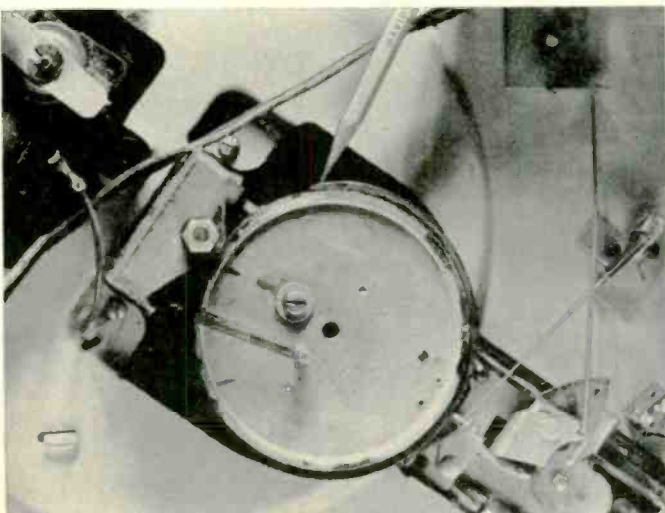

Fig. 5—Old tire on idler must be replaced; this one caused irregular speed and thumping noise.

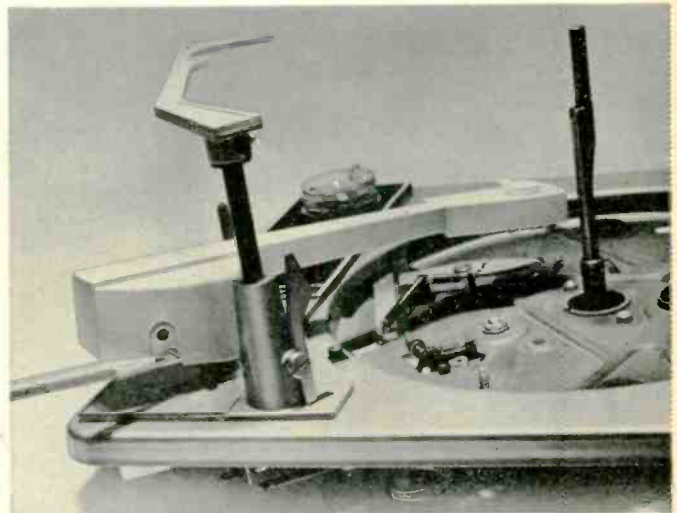

Fig. 6—Landing position screw sets diameter at which stylus comes down and starts to play record.



Video modulator, with its 10-mc bandwidth, produces crisp, top-quality pictures on any good receiver. With suitable changes in rf system, it can be adapted to ham TV.

BUILD A VIDEO MODULATOR FOR CCTV

Low-cost video modulator makes it possible to use any closed-circuit TV camera with any ordinary home TV set

By EARL T. HANSEN

This TV modulator is the connecting link between a closed-circuit TV (CCTV) camera and standard television receivers. With it, the receivers need no internal modification. The modulator will feed several receivers along several hundred feet of transmission line. Crystal carrier control makes it extremely stable.

The bandwidth of the modulator exceeds that of standard receivers and of most cameras. The standard video signal of approximately 1 volt peak-to-peak, terminated in 75 ohms, is more than adequate to drive the modulator.

Tubes rather than transistors were used to keep the cost down. The small size and low power consumption of transistors were of no importance in the planned use. The tubes are operated conservatively for maximum life.

The modulator described here is a thoroughly debugged design. Several units are in operation. With each one, the design was changed to improve performance, simplify adjustment, and reduce the number of parts and cost.

V1 is a conventional overtone crystal oscillator, driving frequency multiplier V2. The output of V2 is coupled to push-pull grid-modulated amplifiers V3 and V4. V6 is a video amplifier and in-

verter. Its gain is controlled by varying the cathode degeneration (R11). The gain is variable from approximately 5 to 15. The dc component of the video signal (black reference) is restored by clamping in the grid circuit of V3 and V4. The grids conduct on the positive-going sync pulse tips and establish a charge on C11 which sets the sync pulse tips to maximum carrier amplitude regardless of average picture brightness. This effectively restores the dc level.

The power supply is a simple choke-input type. This lowers the dc voltage to the desired value and assures good load regulation at 250 volts for the output stage. Lower voltages for other stages are provided by series dropping resistors and decoupling capacitors. A diode in the rf output circuit provides a convenient test point (J2) for tuning (with a vtvm) and checking video modulation (with a scope). The low-value load resistor (R13, 1,800 ohms) on V6 and series peaking coil L4 extend the video bandwidth to approximately 10 mc.

The video input circuit was designed for a *high-impedance loop-through*. The signal from the coax cable goes in J5 and out J6 via coax, and is used or terminated in another part of the closed-circuit system. If you don't expect to need this feature, omit J6 and use R17 to terminate the line properly inside the modulator.

Construction and adjustment

Most component values are not at all critical and good judgment will allow wide deviation. But good layout and short leads are essential in the rf circuitry. I selected channel 10, but your choice will depend on channel allocations in your location. See the table for information on coils and crystal frequencies.

The coil forms were obtained from the i.f. strip of a junked TV chassis. The crystal is soldered in, and supported only by its leads. I used .001- μ f ceramics for rf bypassing, but any capacitors from 470 pf to .005 μ f may be used if they are physically small and the leads are kept short. L5, L6 and L7 are not critical and any high-frequency rf choke may be used. [Ohmite Z-50 should be good for channels 2 through 6, and Z-144 for 7 through 13.—*Editor*]

The sections of C16 may be of higher capacitance, if another type is more readily available. V2, V3 and V4 should be shielded. I dipped the shields part way in black paint to improve heat radiation. Shiny tube shields allow high bulb temperatures and may cause tube failure.

C14 and C15 are located at the V2 socket. R9 should be grounded at J4's mounting. The feedback winding on L1 must be phased correctly. If both wind-

FREQUENCY AND COIL DATA FOR THE VIDEO MODULATOR

Channel	Video freq.	Crystal freq.	Approx. no. of turns		
			L1	L2	L3
2	55.25	27.625	14	10	14
3	61.25	30.625	13	9	13
4	67.25	33.625	13	9	13
5	77.25	38.625	12	9	12
6	83.25	41.625	12	8	12
7	175.25	43.812	12	4	6 $\frac{1}{2}$
8	181.25	45.312	12	4	5 $\frac{1}{2}$
9	187.25	46.812	11	4	5 $\frac{1}{2}$
10	193.25	48.312	11	4	5 $\frac{1}{2}$
11	199.25	49.812	10	4	5 $\frac{1}{2}$
12	205.25	51.312	10	3	4 $\frac{1}{2}$
13	211.25	52.812	9	3	4 $\frac{1}{2}$

Crystals (3rd- or 5th-overtone type) available from International Crystal Co., Texas Crystals, and others.
Feedback winding on L1 and secondaries on L2 and L8 are same for all channels.

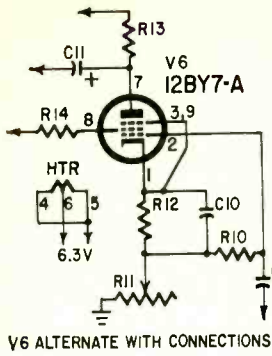

Circuit of the video modulator. No unusual parts are used. The coils are easily wound to suit the chosen channel. Type 6AH6 (V6) may be hard to come by. If so use 12BY7-A, with a 9-pin miniature socket and altered connections as shown at left.

- C1, C2, C4, C5, C6, C7, C14, C15—.001 μ f disc ceramic
- C3, C8—22 pf mica or ceramic
- C9—.01 μ f, 400 volts, paper or Mylar
- C10—470 pf ceramic
- C11—4 μ f, 450 volts, electrolytic
- C12, C13—.01 μ f, 600 volts
- C16—60/40/20- μ f 350-volt 3-section electrolytic (Sprague TVL-3640 or equivalent)
- D—1N64 germanium diode
- F—fuse, 1 ampere
- J1, J2—banana or pin jacks
- J3, J4, J5, J6—coax connectors, type SO-239 or similar
- L1—No. 22 wire on $\frac{1}{4}$ -in. slug-tuned form (Miller 4500 or equivalent). See Table
- L2—No. 22 wire for high channels (7-13); No. 26 for low (2-6), on $\frac{1}{4}$ -in. slug-tuned form. See Table
- L3—No. 16 wire for high channels, No. 20 for low. See Table. Secondary is 1 turn No. 20 tightly coupled
- L4—50- μ h rf choke (Millen J300-50 or equivalent)
- L5, L6, L7—rf chokes: approx. 25 turns No. 22 enameled, air-wound $\frac{3}{16}$ in. dia.; or see text for commercial chokes.
- CH—filter choke, 7 h, 55 ma (Thoradson 20C59

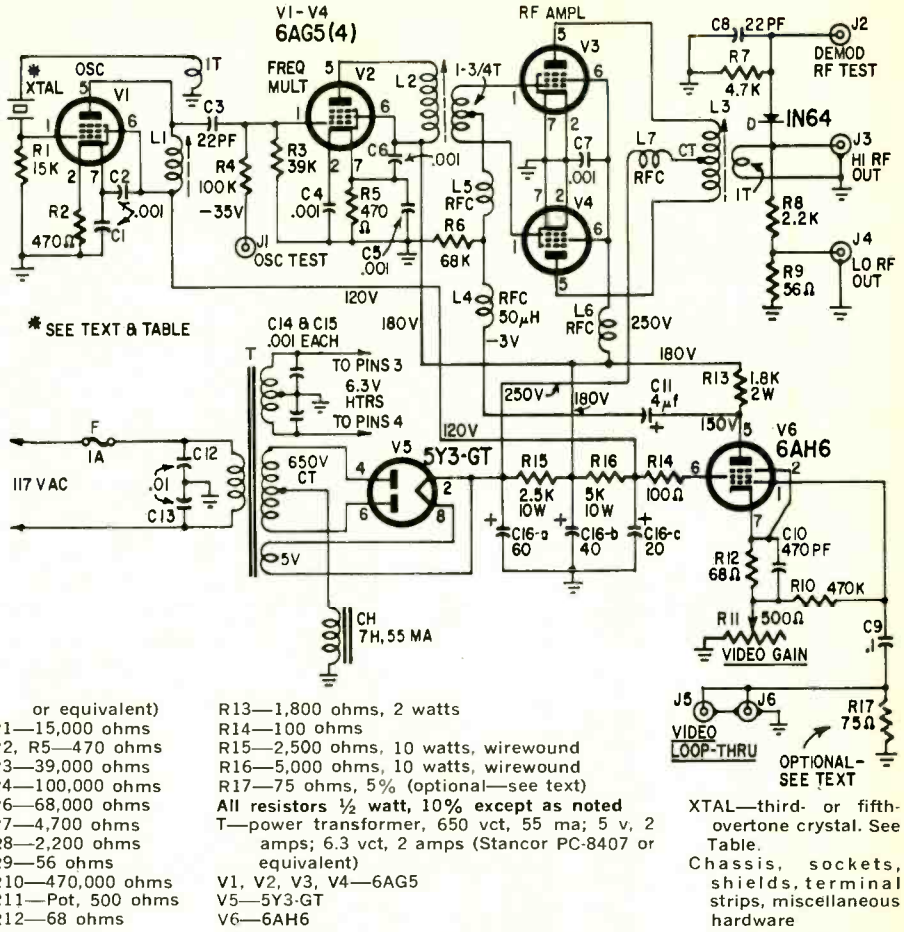

- or equivalent)
 - R1—15,000 ohms
 - R2, R5—470 ohms
 - R3—39,000 ohms
 - R4—100,000 ohms
 - R6—68,000 ohms
 - R7—4,700 ohms
 - R8—2,200 ohms
 - R9—56 ohms
 - R10—470,000 ohms
 - R11—Pot, 500 ohms
 - R12—68 ohms
 - R13—1,800 ohms, 2 watts
 - R14—100 ohms
 - R15—2,500 ohms, 10 watts, wirewound
 - R16—5,000 ohms, 10 watts, wirewound
 - R17—75 ohms, 5% (optional—see text)
- All resistors $\frac{1}{2}$ watt, 10% except as noted
- T—power transformer, 650 vct, 55 ma; 5 v, 2 amps; 6.3 vct, 2 amps (Stancor PC-8407 or equivalent)
 - V1, V2, V3, V4—6AG5
 - V5—5Y3-GT
 - V6—6AH6
- XTAL—third- or fifth-overtone crystal. See Table.
Chassis, sockets, shields, terminal strips, miscellaneous hardware

ings are wound in the same direction, the start of the primary connects to the plate of V1, and the start of the feedback loop goes to ground. Couple the secondary of L2 loosely to the bypassed end of the primary. The secondary of L3 should be tightly coupled to the center of the primary. If a grid-dip meter is available, check the tuning range of the coils. L1 should tune through the crystal frequency. L2 and L3 should tune to the video frequency of the selected channel.

Apply power and check approximate voltages to chassis, as shown on the schematic. Voltages are approximate and may vary considerably with transformer voltage and tube characteristics. Connect a vtvm to J1. Start with the -50-volt range. Adjust L1 for maximum voltage. If the feedback loop is too loosely coupled, V1 may not oscillate; if too tightly coupled, it will oscillate at any setting of the tuning slug as indicated by a continuous voltage at J1. Adjust coupling by sliding the L1 loop along the form. Tune L1 slightly on the high-frequency side of maximum output to assure reliable starting of the oscillator. Typical readings at J1 range from -25 to -40 volts.

Connect the vtvm to the junction of L4 and C11 and tune L2 for maximum negative voltage. If it is greater

than -5 volts, reduce the coupling of the L2 secondary. Connect the vtvm to J2. Tune L3 for maximum output. Connect a 75-ohm load to the HI RF output, J3, and retune L3. The dc voltage at J2 is a direct indication of the average

rf output and is very useful for tuning. Apply a 1-volt peak-to-peak sine wave to the video input (60 cycles or any audio frequency will do). Connect a scope to J2 and observe a sine wave. Adjust the video gain for maximum

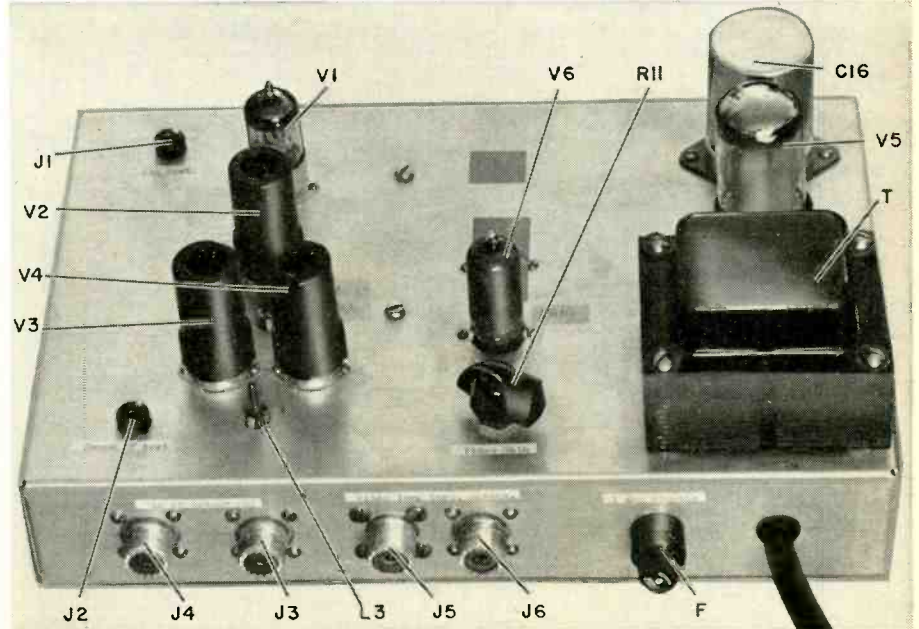

Tube shields over three of the 6AG5's were dipped in black paint to improve heat radiation.

amplitude without clipping.

The average dc level at J2 will drop 25% to 50% as an input signal is applied. This is normal for this type of grid modulation and dc restoration. For actual video input, the voltage at J2 will depend on the average scene brightness.

Using the modulator

The modulator will work well with any video source of approximately 1 volt peak to peak, and negative-going sync. I used a Motorola transistor closed-circuit camera, coupled to the modulator through approximately 150 feet of 75-ohm RG-59/U, with excellent results. The high rf output (J3) puts out about 1 volt, and is intended to feed a long terminated line with coupling to the TV sets through highly attenuating tapoffs. The low output (J4) supplies about 5,000 microvolts and may be coupled directly to several standard receivers.

When only the low-output jack is used, the high-output jack should be terminated with a 75-ohm carbon resistor for best modulation linearity. Make the final adjustment of the video gain while watching a TV receiver. Low gain will show as low contrast. Excessive gain will cause loss of detail in the highlights.

For the final tuning of L3, with the

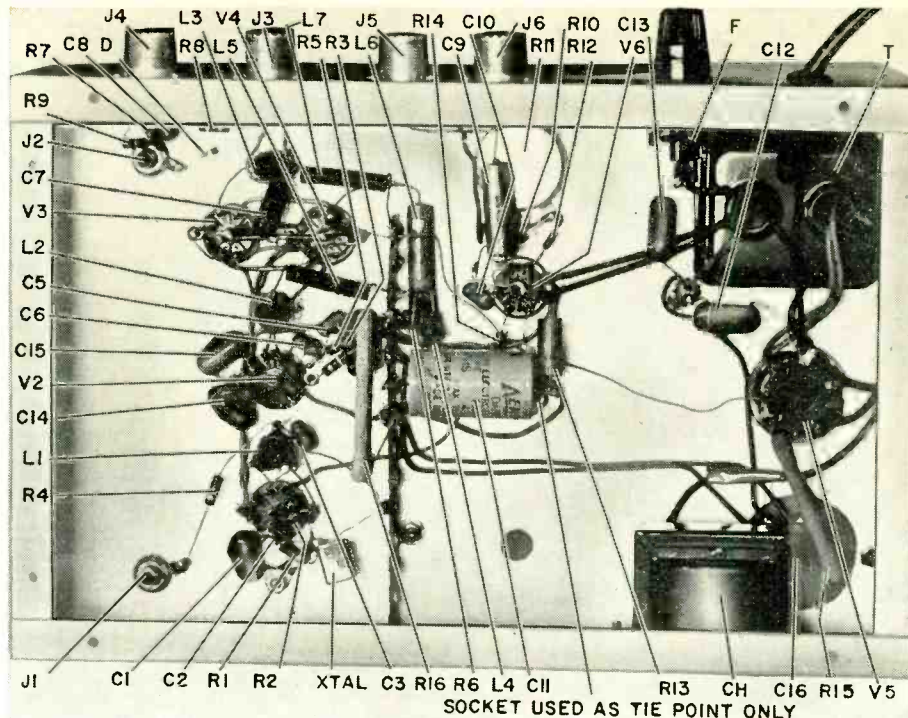

Resist the temptation to spread out too much in the roomy chassis. All leads except dc-carrying power-supply wires must be kept short and routed direct.

unit connected to the distribution system, back the slug out for about 20% reduction in dc voltage at J2. This will favor the upper sideband. You need not

attempt to reduce the lower sideband greatly. The receiver bandpass characteristics take care of the vestigial sideband problem. END

Selective AF Amplifier Boosts Receiver Performance

By I. QUEEN

EDITORIAL ASSOCIATE

THIS CIRCUIT ADDS HIGH SELECTIVITY when tacked onto the output of a ham CW receiver. It uses commonly available components and requires only two penlight cells. It has a bandwidth of less

than 120 cycles at 20 db down, with sufficient output for a high-impedance earpiece. The circuit is peaked at 900 cycles.

Positive feedback occurs through R7, which is adjustable. Negative feedback occurs through the bridged-T network tuned to 900 cycles. Because of the bridged-T, gain is very low at all fre-

quencies except 900 cycles. As R7 is reduced, gain at resonance is boosted. Pushed too far, the circuit becomes unstable and eventually oscillates. Selectivity can be made extremely sharp, but the amplifier will tend to "ring". The bandwidth mentioned above is obtained without reducing R7 so far that ringing sets in.

For maximum selectivity, the signal must not be too great. Results are satisfactory when the voltage across the earpiece is about 30 mv.

The extreme selectivity of 120 cycles at 20 db down may be compared with that of a modern ham receiver, whose selectivity may be rated at 500 cycles at 6 db down. Of course, when they are added together, the result is a very sharp peak, which rejects interference and noise.

R7 must have enough range. If you cannot get oscillation, reduce or eliminate R8. On the other hand, if oscillations cannot be stopped by R7, you may need to increase R8. The polarity of the output transformer must be correct also, otherwise the feedback through it will be negative instead of positive. If you can't get the circuit to oscillate, reverse the leads to one winding.

To use the filter, adjust the bfo tuning, bandspread tuning or both for the best performance. END

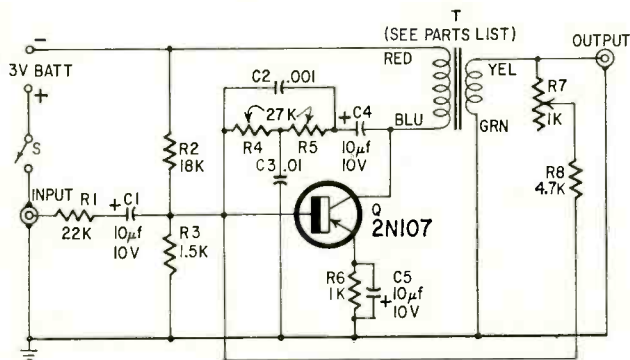

- C1, C4, C5—10 µf, 10 volts electrolytic
- C2—.001 µf, disc
- C3—.01 µf, disc
- R1—22,000 ohms
- R2—18,000 ohms
- R3—1,500 ohms
- R4, R5—27,000 ohms
- R6—1,000 ohms
- R7—1,000-ohm potentiometer

- R8—4,700 ohms
- all resistors, ½ watt
- T—transformer, 200,000-ohm pri to 1,500-ohm sec (Argonne AR-144 or equivalent)
- Q—2N107 or similar
- BATT—2 penlight cells, and holder (3 volts)
- S—spst switch
- perforated board, 3½ x 4¾"

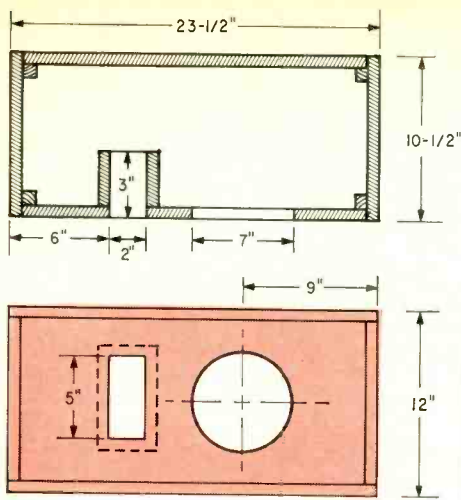
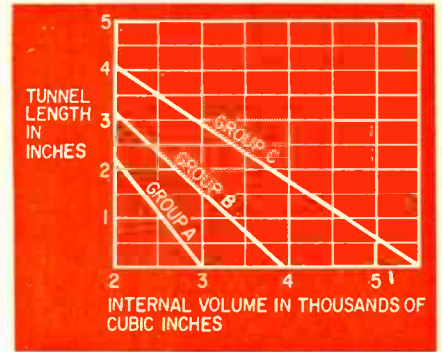

Fig. 1—A minimum-volume ported enclosure for an 8-inch "general-purpose" speaker.

Fig. 2—Tunnel (duct) length for small enclosures with 10-square-inch port opening. Lengths on chart are measured from back of baffle-board. Group A includes speakers with light cone and stiff suspension (most general-purpose types.) Group B is light cones and soft suspension (many "bargain" hi-fi speakers). Group C is speakers with heavy cones (such as woofers).



Long Ones, Short Ones, Fat Ones, Tall Ones

By **GEORGE L. AUGSPURGER**

ALMOST EVERYONE WHO HAS WORKED with bass-reflex speaker enclosures knows that there is a fairly narrow optimum range of sizes and shapes for them. Straying too far in the direction of a column or pipe shape, for instance, can create serious standing-wave problems and unpleasantly colored sound. Most articles warn you to that effect, but hardly any tell you whether it's at all possible to come up with a satisfactory enclosure design if you *have* to use an odd shape.

[For details on more orthodox designs, see Mr. Augspurger's "Design Your Own Speaker Enclosure" in the August 1964 issue of *RADIO-ELECTRONICS*.]

The very small enclosure. Although a general-purpose speaker in a small enclosure will do nicely for background music or a paging system, deep bass tones invariably sound thin. In extreme cases, there may even be a pronounced "honky" quality which is almost impossible to get rid of. Nevertheless, there are instances where this combination of

speaker and enclosure is the only one that which can be used, and the assignment is to make the speaker perform as well as possible in the space available.

Fig. 1 gives dimensions for a minimum-volume ported enclosure for an 8-inch speaker. The unit gives good results, yet is compact enough to put on a shelf or behind the back seat of a Volkswagen. Its internal volume is 1.2 cubic feet, and the ducted port is worked out from the chart in Fig. 2. In very small enclosures such as this, it is usually preferable to line *all* interior surfaces except the front panel with acoustical padding.

The very thin enclosure. There is considerable demand for speaker enclosures shallow enough to be concealed behind draperies or hung on a wall. Not only is such an enclosure very limited in its internal volume, but the squashed-out shape sets up standing waves which may interfere with the normal function of the enclosure. These can be controlled by a liberal use of absorptive padding, but the ordinary utility speaker still does not work quite as well as with boxier proportions.

A recommended thin design is shown in Fig. 3. Note that the port duct is combined with the bracing of the front and back panels. The duct goes back from the front panel and then opens out sideways into the enclosure interior. Thus, the effective length of the duct is roughly equal to the figure recommended in the chart.

The very long enclosure. Often, there is sufficient volume to get good performance from a speaker, but the available space is more in the shape of a pipe than a box. Here again, judicious use of absorptive material will help. By placing speaker and port close together, with the speaker centered at one-fifth the total length of the pipe, standing-wave problems are minimized. The suggested configuration is shown in Fig. 4. A pair of these cabinets placed end to end makes a convenient installation hung on a wall to serve as a shelf, or concealed in a valance above a picture window. Or the enclosures can be set vertically, taking up very little floor space, yet getting the speakers up to a height where sound can be projected over other furniture.

END

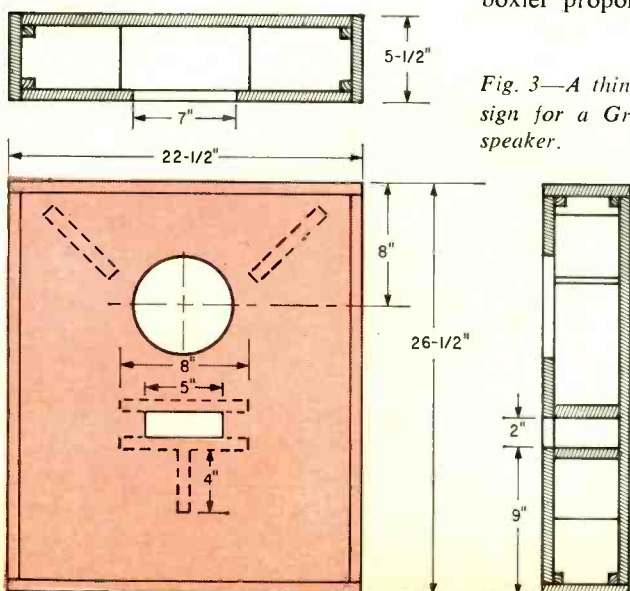

Fig. 3—A thin enclosure design for a Group B 8-inch speaker.

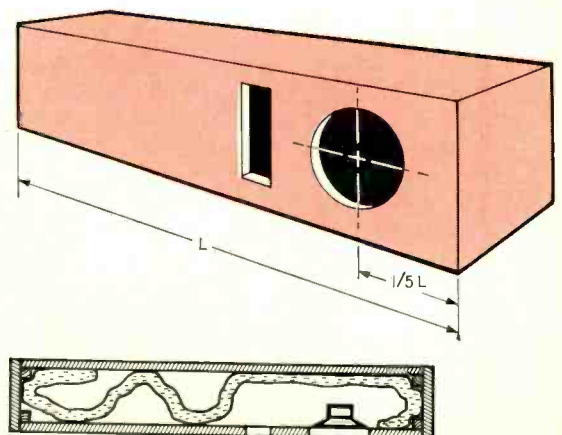

Fig. 4—A typical very-long enclosure. Absorptive material damps standing waves.

Instrument you can build in an evening measures inductance, checks resonance with the help of an audio or rf generator

QUICK HENRY!

By FRED BLECHMAN K6UGT

Measuring the inductance of a choke, i.f. transformer, toroid or any other coil is a clumsy process. Unless you have an inductance bridge, you usually avoid measuring inductance because of the "difficulty." With Quick Henry, anyone with an audio generator can measure inductance quickly and easily from less than 1 mh to over 5 henries. With an rf generator, measurements can be made down to a couple of microhenries. Quick Henry will allow you to determine the resonant frequency and Q of audio and rf circuits from below 100 cycles to over 30 mc with reasonable accuracy. The resonant frequency of unmarked i.f. transformers can be found easily, and you can determine the inductance of unmarked filter chokes, slug-tuned coils, and rf chokes. You can design, test and trim audio bandpass circuits to your requirements.

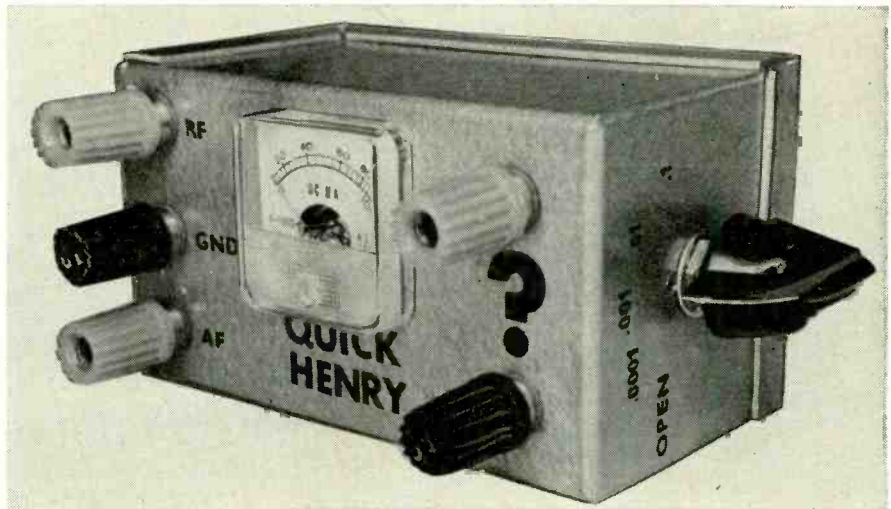

Quick Henry takes up amazingly little space for its versatility.

Fig. 1—Circuit of Quick Henry.

Quick Henry's built-in meter indicator is optional. If you have a 10,000-ohm/volt or better multimeter, use it instead. The total cost of parts for Quick Henry, including the meter specified in the parts list, is only \$8. If you prefer to use a meter you already have, the cost drops to only \$3.50!

Circuit description

Fig. 1 is the schematic of Quick Henry. A signal fed to posts J1 or J3 and ground (J2) passes through R or C1 and then through the unknown inductance connected between J4 and J5. Switch S1 selects an appropriate capacitor (C2, C3, C4 or C5), which is placed in parallel with the unknown inductor. The input frequency is varied, and at the resonant frequency of the unknown L and the selected C in parallel, the voltage across J4-J5 increases sharply. This is because at resonance the parallel L-C circuit suddenly becomes a high impedance to the signal, shunting less of it around the meter. The further from resonance, the lower the impedance, depending on the Q, which we'll get to later.

This ac voltage across the unknown inductor is rectified by diode D and passed on to the sensitive dc microam-

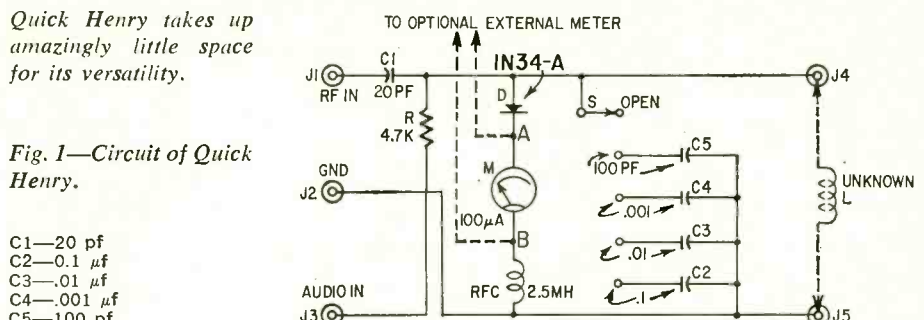

- C1—20 pf
- C2—0.1 μ f
- C3—.01 μ f
- C4—.001 μ f
- C5—100 pf
- D—1N34-A or equivalent
- J1-J5—Insulated 5-way binding posts (Lafayette 99 R 6233 or equivalent)
- M—1-inch clear plastic 100- μ A meter (Alco P-1000** 0-100 range), or 1 $\frac{1}{8}$ -inch 50- μ A meter (Lafayette 99 R 5049)
- R—4,700 ohms, $\frac{1}{2}$ watt
- RFC—2.5-mph rf choke (National R-50 or equivalent)
- S—5-position switch (Lafayette* 99 R 6164 or equivalent)
- 4 x 2 $\frac{1}{4}$ x 2 $\frac{1}{4}$ -inch aluminum box
- *Lafayette Radio-Electronics Corp., 111 Jericho Turnpike, Syosset, N. Y. 11791
- **Alco Electronic Sales, Inc., 3 Wolcott Avenue, Lawrence, Mass.

Building it

I built my instrument into a standard 4 x 2 $\frac{1}{4}$ x 2 $\frac{1}{4}$ -inch two-piece aluminum box. Wiring is not critical, but don't make the leads longer than necessary, and place S, C2, C3, C4 and C5 near J4 and J5. Be sure that all binding posts are insulated from the box; there shouldn't be any connections to the box.

The 1-inch meter and five-position switch specified in the parts list contribute to the small size of the unit, but any equivalent switch or meter may be used if you don't mind a bigger box. The alternate meter listed will still fit in the specified box, is less expensive and more sensitive than the meter I used, but it does take up more space.

If you intend to use an external multimeter to detect resonance instead of building a meter into Quick Henry, bring two additional binding posts out on the side of the unit. These points are marked A and B on the schematic. Mark these posts with the proper polarity.

meter M and the rf choke RFC. When you use an rf generator, the signal is coupled to the resonant circuit through C1, a 20-pf capacitor.

Capacitors C2 through C5, selected by S, allow a broad range of L-C ratios. The OPEN position of S allows you to measure external resonant circuits or to trim an inductor with exactly the value of capacitance needed for resonance.

Using it

Most inductors with many turns of wire wound on a ferrite or iron core measure over 1 mh, and can be checked by using an audio generator with Quick Henry. For air-wound coils, use an rf generator. Never connect *both* generators to Quick Henry at the same time, because all sorts of spurious signals will result. Connect the generator to J2 and either J1 (rf) or J3 (audio). To start, set S to the .001 position. Starting at the low-frequency end, vary the frequency, changing generator frequency bands when necessary, until you see a clear meter deflection. There may be minor spurious responses (especially with an rf generator and measuring in the low microhenry range), but these can be ignored.

If you don't find any response, switch S to the next higher value, and sweep the frequencies again. When you do get a response, it will be quite definite, and might "pin" the meter. Adjust the generator output for a comfortable peak reading. Most audio generators have enough output to deflect the meter well beyond full scale, and rf generators will give at least half scale under most conditions. The best accuracy comes with the highest value of C that gives a sharp peak meter reading, so readjust the position of S if necessary. A broad peak—that is, one which is not too definite as you vary frequency—is "low Q", and may be improved by using a higher value for C (setting S to a higher value).

Once you have found the best setting for S, use Fig. 2 to determine the inductance of the unknown coil if you are using an audio generator, or Fig. 3

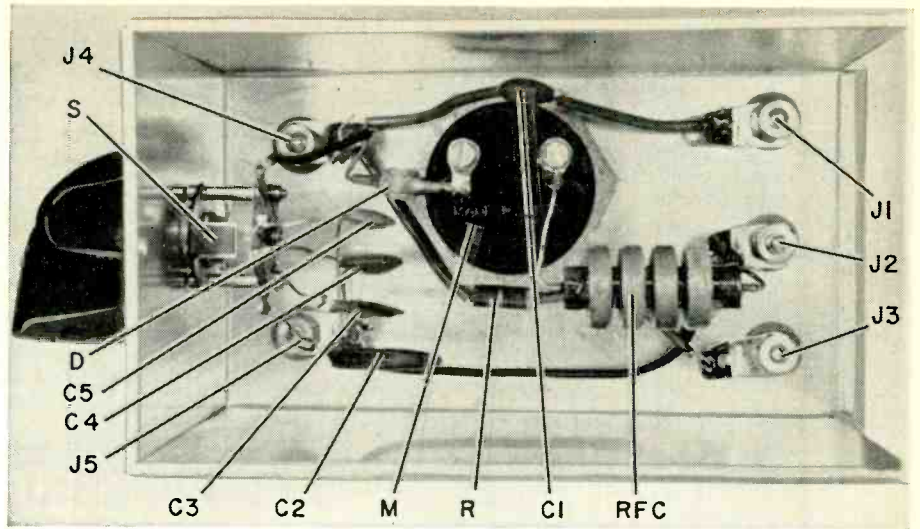

What's inside the box. Tiny rotary switch and 1-inch meter help make wiring easy.

if you are using an rf generator. Enter the horizontal axis at the resonant frequency, as read on the generator dial; move directly upward until you intersect the line that represents the value of capacitance selected by S, and then move straight to the left and read the value of the unknown inductance on the vertical scale.

To determine the resonant frequency of, say, an unmarked i.f. transformer, connect one of the windings (an ohmmeter will identify the windings by continuity) to J4 and J5, and set S to OPEN. Using an rf generator, find the frequency that peaks the meter, and read this resonant frequency right off the generator dial. A particular value of capacitor can be connected across an unknown inductor, and the resonant frequency determined the same way.

You can actually plot the audio bandpass of an R-C or L-C network by taking successive meter readings near resonance and plotting them on graph paper, with frequency along the horizontal axis and meter reading along the vertical axis. In this case, it is convenient to set the generator output to read full scale on the meter at resonance.

Figs. 2 and 3 have been plotted showing only the values of capacitance I used. If you want to use other values, either internally or connected to the binding posts externally, you'll find it worth while to get a slide-rule resonance calculator, such as the Shure Reactance Slide Rule (Allied Radio, catalog No. 37 U 950E, \$1 postpaid). This covers resonant L-C combinations from 5 cycles to 500 mc.

Series-resonant circuits can also be

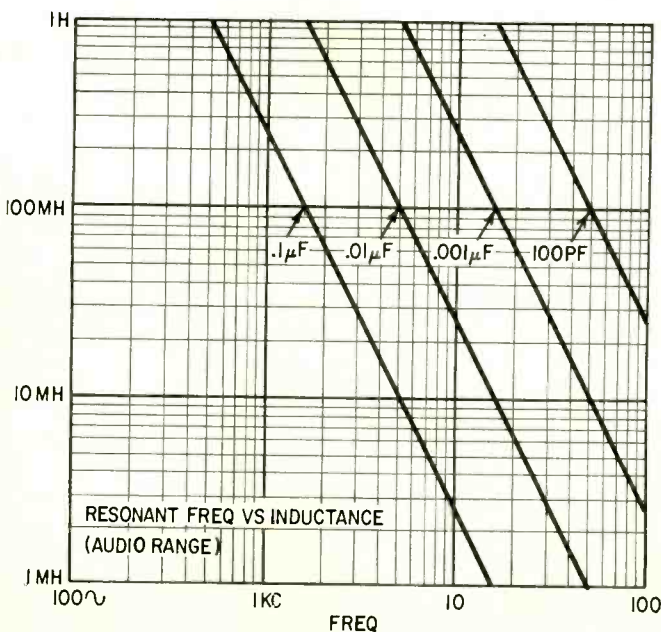

Fig. 2—Chart of resonant frequency inductance in the range of an audio generator.

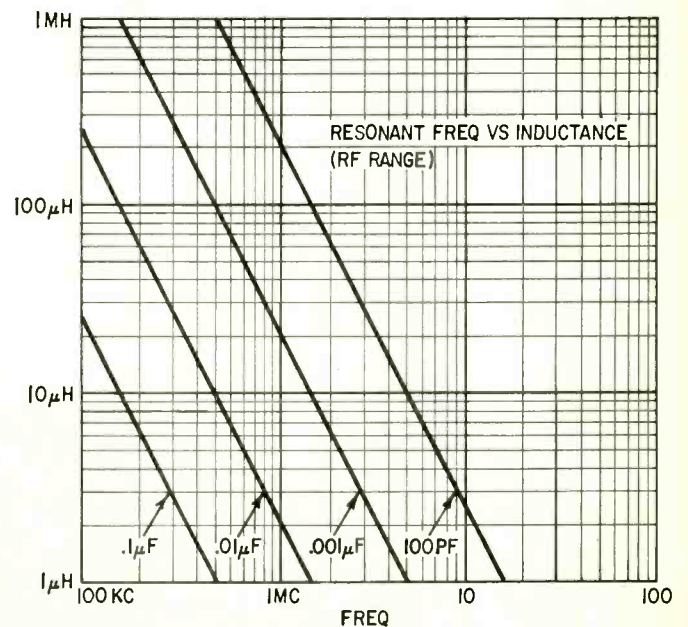

Fig. 3—Chart of resonant frequency inductance in the range of an rf generator.

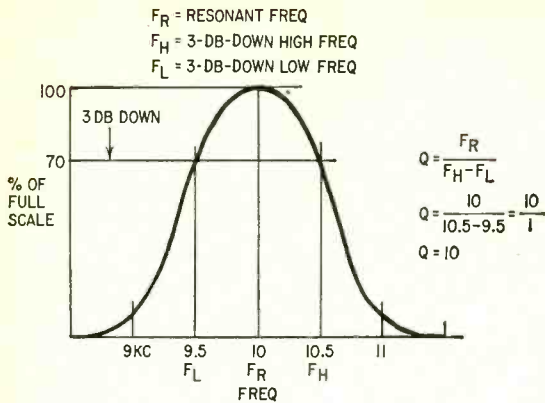

Fig. 4—Q-measuring formula and example.

measured across J4 and J5 by noting a dip in the meter reading, since at resonance the tuned circuit will effectively short out the meter circuit.

To find the Q (figure of merit) of a resonant circuit, set the peak meter reading to full scale by adjusting the generator output. Now vary the input frequency on both sides of the resonant frequency to the points where the meter reads 0.7 of full scale (3 db down). Note the frequencies where these meter readings occur, and apply the formula given in Fig. 4, which shows an example of a Q calculation.

When you use an external multimeter instead of the built-in meter ar-

angement to sense resonance, set the multimeter on its lowest dc voltage range, observing proper polarity. Do not use the current scales.

The accuracy of Quick Henry does not qualify it as a laboratory standard by any means. Numerous errors are cumulative, such as the accuracy of your capacitor "standards," the internal

capacitance of the circuitry, the external capacitance of test leads and the calibration accuracy of the signal generators used. However, for hams and home experimenters, radio and TV service shops even for small labs, Quick Henry will satisfy a long-felt need to measure inductance and resonance quickly and cheaply. END

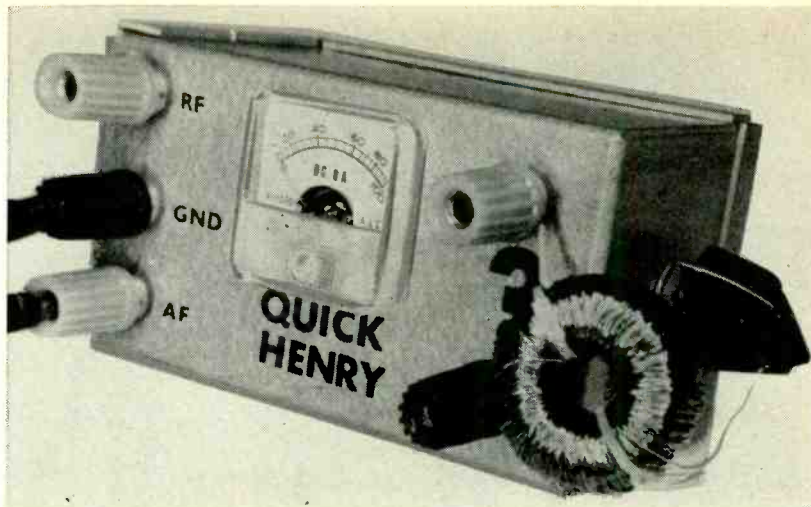

Checking an unknown toroid is no trick with Quick Henry. Select a capacitor with the switch, then adjust the audio generator until you see the meter peak.

WHAT'S YOUR EQ?

Conducted by E. D. CLARK

How Many Relays?

Using ordinary spst toggle switches, working from any standard



type of power, how many relays can you control on the far end of this shielded two-conductor line, each entirely independent of all others?—Eugene Austin

Two puzzlers for the students, theoretician and practical man. Simple? Double-check your answers before you say you've solved them. If you have an interesting or unusual puzzle (with an answer) send it to us. We will pay \$10 for each one accepted. We're especially interested in service stinkers or engineering stumbers on actual electronic equipment. We get so many letters we can't answer individual ones, but we'll print the more interesting solutions—ones the original authors never thought of.

Write EQ Editor, Radio-Electronics, 154 West 14th Street, New York, N. Y. 10011.
Answers to this month's puzzles are on page 101.

Glow-Lamp Memory Circuit

This flip-flop memory circuit uses two NE-23 neon glow lamps and a 30:1 audio output transformer that functions as a voltage-peaking transformer. The output is in the form of transient peaks that exceed 45 volts and are sufficient to fire a nonconducting lamp.

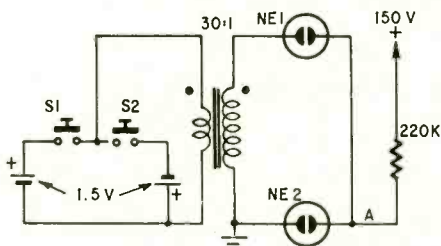

When the circuit is stable, one lamp is on and the other is off. The voltage requirements of NE2 are: firing voltage 75, maintaining voltage 65, and extinguishing voltage 64. NE1 has a firing voltage of 70, maintaining voltage of 60 and extinguishing voltage of 59.

The pushbuttons (S1, S2) are normally open and each is correlated to a glow lamp. When a button is pressed, the lamps will flip. Upon release, they will flip. Can you determine which lamp will flip into steady conduction if S1 is pressed for 1/2 second and released?—Kendall Collins

50 Years Ago

In Gernsback Publications
 In January, 1916
 Electrical Experimenter
 Microphonic Device Detects Submarines 20 Miles Away
 Transmission of Photographs Telegraphically
 Regenerative Audion Circuits for Wireless Receiving
 Hearing Through Your Teeth
 Ultra-Sensitive [Baldwin] Telephone Receiver

Which Generator For Color Service?

Of the three types, the keyed-rainbow generator is taking the lead. But it's wise to know what else is available, and why.

By **ROBERT A. DUNN** and **DON D. HERZEG***

THE MOST IMPORTANT PIECE OF EQUIPMENT FOR SERVICING color TV is a color generator. It's a must for setting up new sets and as an aid to servicing sets with problems. It should provide a composite sync and color signal similar to the one transmitted by a television station, and it should develop all the signals and patterns necessary for convergence and testing.

Some color generators are much superior to others and less likely to become obsolete because of changes in receiver sync circuitry.

Should you buy a unit that produces a rainbow pattern, a keyed rainbow or a National Television System Committee (NTSC) signal? Before you decide, learn here how each type of signal looks on the screen and how it can be used. No less important are the additional patterns necessary for convergence.

Rainbow

The display pattern developed from this signal resembles a rainbow (Fig. 1). The color starts at the left of the screen at green and blends continuously into shades of yellow, red, blue and back to green at the right side. This rainbow color display is produced by the *offset subcarrier* method. The frequency of the subcarrier is offset 15,750 cycles below the normal color subcarrier of 3.579545 mc, and so

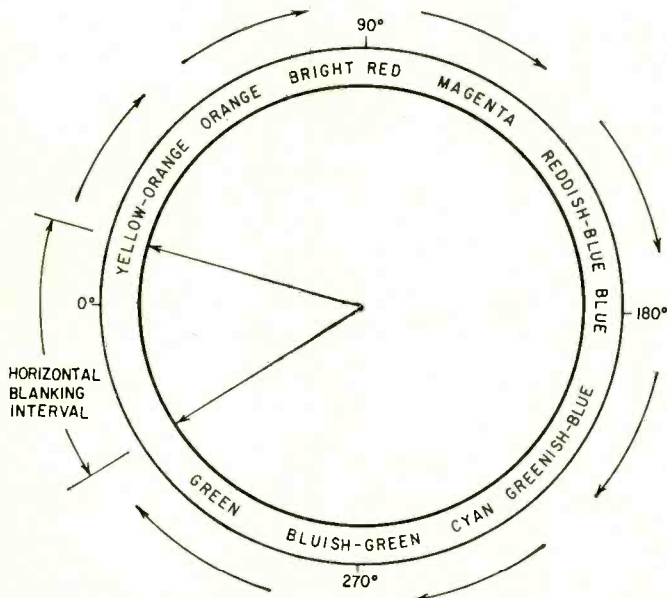
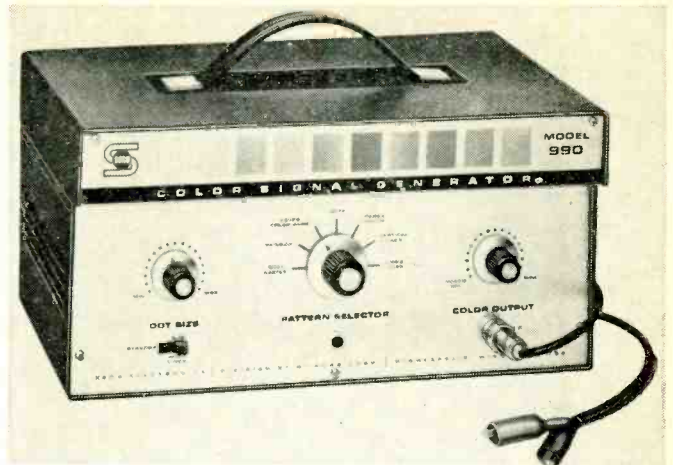

Fig. 1—Rainbow signal runs through the whole gamut of colors during the time of one horizontal sweep. Display is a gradual shading of one color into another, without distinct separation.



Seco 990 makes keyed or unkeyed rainbow.

becomes 3.563795 mc. This signal and the horizontal sync pulse of 15,750 in composite form are then fed to the TV receiver.

The offset subcarrier signal and the signal from the 3.579545-mc oscillator in the receiver are applied to each of the color demodulators. The difference in frequency between these two signals is then 15,750 cycles or 1 cycle of difference for each complete horizontal scanning period. This causes the relative phase between these two signals to change through one complete cycle, 0° to 360° in each horizontal scanning period. Consequently, each demodulator produces a sine-wave output of 1 cycle in each horizontal scan period. The sine-wave output signal has maximum positive amplitude at 90° in an R — Y demodulator, at 180° in a B — Y demodulator, and at approximately 300° in a G — Y demodulator. These three signals produce a continuous rainbow pattern on the picture tube.

Probably the greatest limitation of the rainbow color signal is the impossibility of knowing exactly where on the screen the R — Y (90°) and B — Y (180°) phases occur. It is necessary to be able to locate these points to align receiver demodulators properly. The rainbow color signals do allow some visual troubleshooting, even though it is not possible to determine accurately where specific colors and their phase relationships occur on the screen. For example, absence of any primary color could indicate an inoperative color amplifier, defective or detuned demodulator or a defective color gun.

The rainbow is usable also for checking the range of the hue and color controls by observing the picture. Brightness control is usually not included in the generator, and therefore the display may look washed-out compared to other types of pattern.

Although the rainbow display is useful, it is limited in versatility. It provides some information, but does not contain all the necessary features to do a complete job of servicing.

Keyed rainbow

The *keyed* rainbow (*gated*, or turned on and off) is produced much like the unkeyed type by producing a complete 360° phase shift with each complete line scan. This pattern is then gated or keyed on and off by an additional oscillator, and part of the original spectrum is removed. This produces 12 color bars with a blank area between each color. The bars are spaced exactly 30° apart (Fig. 2). Only 10 are actually visible in the CRT display: the first of the twelve is used as burst and the twelfth occurs during retrace. The blank areas between the 10 bars are no-color areas and contain no color signals.

*B & K Div. of Dynascan Corp.

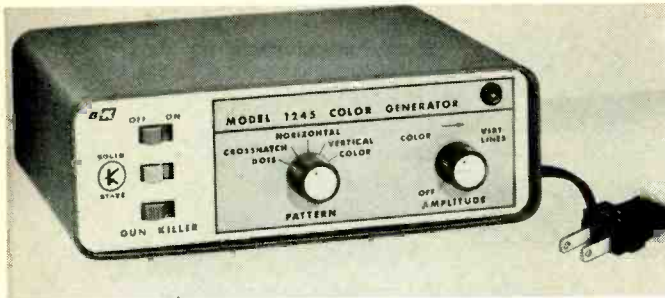

B & K 1245 is typical keyed-rainbow generator.

Keyed-rainbow generators usually use a crystal-controlled oscillator for accuracy. The crystal will maintain 3.563795 mc within .005%, or ± 175 cycles. Thus the phase between the test signal and the oscillator in the receiver is held fast to produce the correct color at the correct location on the screen. The controlled burst (or starting point) holds the R - Y (90°), B - Y (180°), and so forth, at the correct phase relationship. The combination of accurate 360° phase shift over one cycle and controlled burst to maintain the starting point are the main advantages of keyed rainbow.

To change a rainbow to a color bar or keyed rainbow, the unwanted sections of the rainbow display are blanked out. The desired colors are allowed to come through. The blank portions and the color bars are the same width—each 15° wide.

Controlled burst also provides another advantage in keyed-rainbow color generators. The burst signal from the generator, or reference signal as it is sometimes called, contains a minimum of 8 cycles of color burst. This assures adequate duration of color signals to trigger color-killer circuits and color afc circuits in the receivers.

The keyed rainbow has the same uses as an unkeyed rainbow pattern and offers added advantages. The accurate burst frequency assures a proper starting point for the phase shift and permits accurate checking of the ranges of the color and hue controls. The third and sixth bars on the circle (Fig. 3) contain R - Y (90°) and B - Y (180°) signals and can be used for accurate demodulator alignment. The 90° and 180° phase-shift points occur exactly in the center

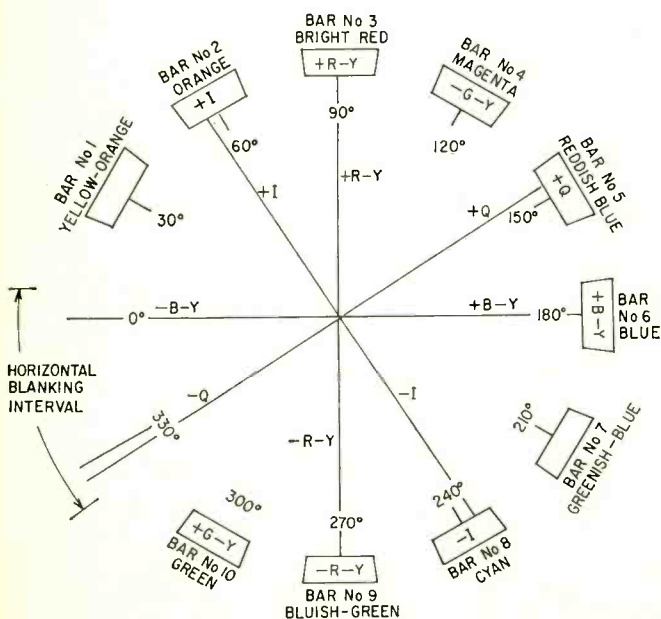

Fig. 2—Keyed rainbow signal is "chopped" to make 10 sharply defined bars, each of a definite color, equally spaced.

of these color bars. By watching the exact center of the color bar the user can correctly align the demodulators.

Manufacturers normally suggest that demodulators be aligned with an oscilloscope. However, with proper test techniques and by allowing only the blue gun or only the red gun to operate during any one test, the keyed-rainbow color display can be used to adjust the R - Y and B - Y demodulators. This is the technique:

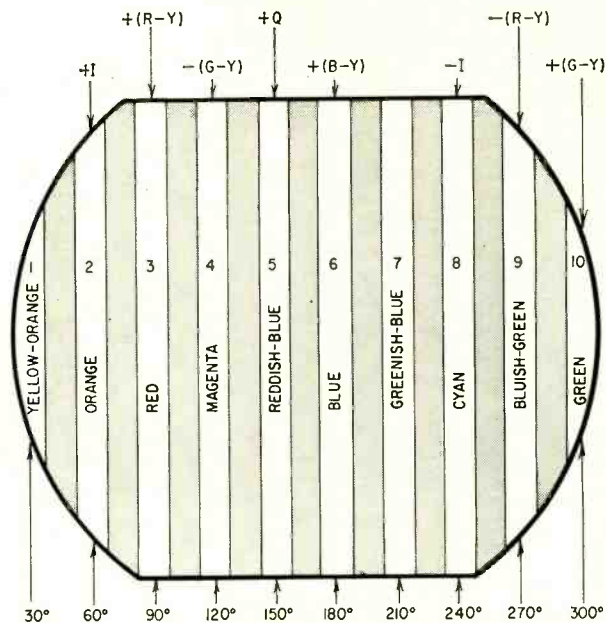

Fig. 3—The 10 bars in keyed-rainbow pattern represent particular phases of chroma signal.

Disable the red and green guns of the CRT (use a gun-killer—100,000 ohms from grid to ground). This leaves only the blue gun operating. The third and sixth color bars contain the information necessary for aligning the R - Y demodulator. The third bar should contain only red, no blue. And, if the receiver is operating properly, there will be no red in the blue (sixth) bar. There should also be no difference in brightness between the third bar and its adjacent no-color areas. The demodulator should be adjusted to produce equal brightness levels. The procedure can be repeated using only the red gun of the CRT and the sixth or B - Y color bar.

This method is not as accurate as an oscilloscope method. It does make possible checking demodulator alignment with a portable generator. Slight adjustments can thus be made in the home without removing the set.

This keyed-rainbow type of signal is the most widely accepted standard. Most manufacturers refer to the keyed rainbow in their service manuals because it is the most useful economically produced color test signal.

NTSC

The National Television System Committee color signal was established by the NTSC. Ten colors were selected, each with its particular phase relationship to the burst or reference signal (Fig. 4), as well as a brightness level.

Generators producing the true NTSC or "crankshaft" signals (called that because of its shape on a scope screen) are quite expensive and consequently are used primarily for factory alignment.

The NTSC generators are generally large because of their complexity and are not portable. (Commonly available units are approximately 20 x 20 x 10 inches and weigh more than 30 pounds.) Other types of generator, such as the

keyed-rainbow type, range from 12 x 10 x 6 inches and 10 pounds to the transistorized units, as small as 8 x 8 x 2 inches and less than 3 pounds.

There are, however, several generators that generate NTSC *type* signals—color signals with accurate phase relationship but without NTSC brightness levels. These generators produce a single color display which the user selects by a switch. Although only a single color is displayed at any one time, many generators allow the burst signals to appear in some area of the screen for reference. By generating and selecting each color individually, the exact NTSC phase relationship to burst can be maintained. R - Y and B - Y signals are exactly 90° and 180° away from burst, respectively. Thus the most accurate color signals possible are available to the user who insists on having them.

NTSC signals (*not* NTSC *type*) allow the user all the advantages of rainbow and keyed rainbow in checking for proper operation of all color receiver circuits, as well as the accuracy just mentioned.

Although there doesn't appear to be any real advantage in viewing all colors at the same time, some technicians have trouble initially with NTSC *type* color signals, which present only one color at a time. Checking the range of hue and color controls requires a little more skill than with other types.

A useful feature in any color generator, regardless of type, is a color amplitude control. This control permits the user to vary the amount of color modulation on the rf carrier—valuable for checking proper sync on color signals, and proper afpc adjustments.

Convergence patterns

Convergence patterns should be considered just as seriously as the color patterns when selecting a color generator. Vertical lines, horizontal lines, crosshatch and dot patterns are necessary for accurate convergence.

Vertical lines are spaced evenly across the screen, producing a display that has a line close to either edge for vertical convergence. These lines are usually slightly less than 1 μsec wide, but a line approximately 0.3 μsec wide or less is a real advantage. It will show a sharper transition between line and background and make convergence much easier. The brightness of the line should not cause excess blooming; that would disturb the high-voltage regulation and thus the focus.

The horizontal pattern should be a single line which

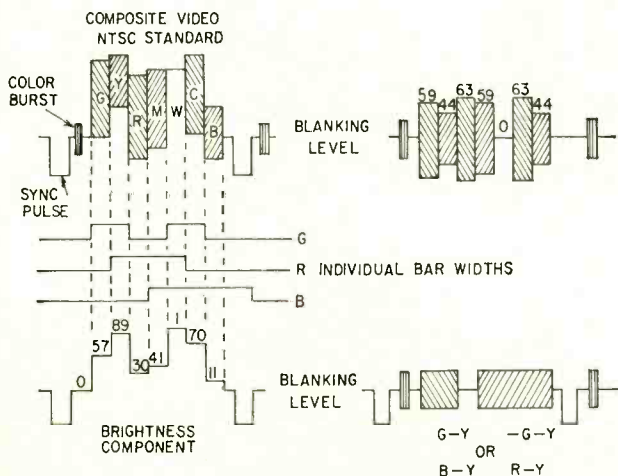
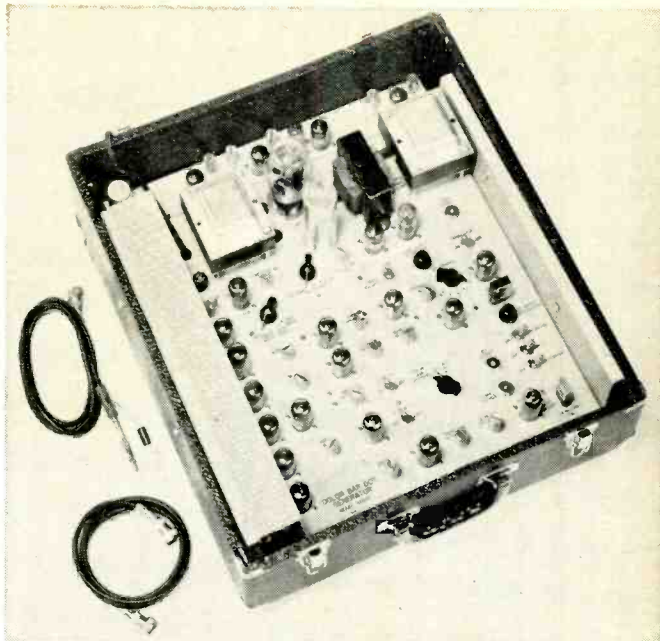

Fig. 4—The “crankshaft” signal—named for the composite-video scope trace’s resemblance to an auto engine crankshaft. Here specific, predecided colors are generated, each with a specific phase relationship to the burst and with a certain amplitude (brightness level).



Hickok 656XC generates NTSC *type* color signals.

originates in the horizontal retrace period and ends just before the next horizontal sync pulse. The single line permits the most accurate convergence. The level of the horizontal lines (and vertical lines) should be adjustable from zero to full output. If the vertical-line amplitude can be reduced to zero, the clear raster can be used for purity adjustments.

Crosshatch is the combination of the horizontal and the vertical lines. Their brightnesses should be equal. The patterns should be straight with the background clean and free of retrace lines at a normal brightness setting.

Dots are the intersections of the vertical and horizontal lines. Therefore, they can be only as sharp as the vertical line—and the narrower (shorter duration) the better. They are usually used for center convergence, but some service technicians prefer dots for all-over convergence.

Certain parts of generator performance can be evaluated nicely by analyzing them on a black-and-white set. The greater video bandwidth of the black-and-white set will show up any *ringing* (a ghost pattern). Ringing indicates that the pattern will be much more difficult to use on the color set for convergence because the image will not be clean and sharp.

The generator will not be as useful as it can be if the horizontal sync pulse information it provides is not accurate. This is the most important information the color signal must bear, for adjustment of color and hue controls and accurate convergence. Naturally, the set was designed to operate from a TV station signal to assure that the set is color-synchronizing on the back-porch section of the horizontal sync pulse. Absence of back porch can cause unstable color sync and may cause you to misadjust something.

The *color killer* is a threshold adjustment that is made most reliably with a black-and-white sync signal with a back porch. If video signals are present during the back-porch period of black-and-white patterns, they may key the color-burst amplifier and cause distortion of the pattern.

An excellent way to select a color generator is to connect it to a color set and observe how easily or how hard the set syncs with the color signal, and if the colors appear at the same place every time when the generator is turned off and on. This same sync test can be tried with black-and-white signals to determine the ease with which a set syncs to the generator. There should be no need for repeated or finicky sync adjustments.

END

MALE

career opportunities with

Programmers SYSTEMS & APPLICATIONS

Professional programmers with college degrees and 2 or more years of experience on large-scale computers are needed to participate in the specifications and implementa-

MALE HELP WANTED
TECHNICIANS

MAINTENANCE
TECHNICIANS

For
Commercial
communications
Equipment

are immediate opening
technical school graduate
related experience,
with equivalent training
experience. Must have
class FCC radio tele-
phone license and telecom-
munications experience. Ac-
quaintance in data communi-
cations systems and
transmission systems
is helpful.

LABORATORY TECHNICIAN

High school graduate with good technical ability and high intelligence to train for photo- resist application of precision patterns in metal and on glass.

Complete benefit program including profit sharing

ELECTRONIC TEST TECHNICIANS

Production testing and trouble- shooting of VHF and UHF aviation radio equipment. Exceptional opportunity for permanent first and second shift positions with AAA standing profit-sharing program. Male and female.

MECHANICAL DRAFTSMEN

Male openings for both local and experienced draftsmen. High school graduates, preferably with advanced schooling in drafts- manship. These

ELECTRONIC TECHNICIANS

Permanent positions offering excellent working conditions and new equipment. Mir- aculous opportunity for a

ELECTRONICS TECHNICIAN

With experience in transis- tor circuitry and electro- mechanical devices wanted as an incoming assistant for experimental work in the development of data com- munication equipment. Ex- cellent technical background and full familiarity with

ELECTRONIC WIRING & SOLDERING

We are adding to our staff and need workers on precision electronic equipment. Ability to read

ELECTRONIC SERVICE TECHNICIAN

Radio and television service. Must be able to troubleshoot electronic equipment. Gas less, colorless, DC, minimum 3 years experience plus ac- credited training. Excellent salary and benefits.

ELECTRONIC MICRO-ELECTRONICS

Sell, up, maintain, and trouble shooting electronic equipment in testing micro- electronic units. Good training program. Excellent salary and benefits.

DATA REDUCTION TECHNICIANS

Duties involve scanning film records of radar and optical data. Use log and data sheets. Various voice recordings and processing of data. Must be able to read and understand data characteristics. Operate procedures and signature

TECHNICIANS

FOR ANALOG, DIGITAL AND HYBRID COMPUTERS & CALIBRATION

We offer challenge, advanced educational opportunities and the opportunity to learn the latest advances in computer technology.

GOOD SALARY
LIFE-SPAN SAVINGS PLAN

RADAR SYSTEMS

Long term opportunity in an exciting field. Excellent educational and training opportunities available.

Requires 3 or more years experience in radar system design, analysis and evaluation. Associate degree preferred. Bachelor's degree of electronics engineering with emphasis on radar systems and display systems. Excellent salary and benefits.

ELECTRONIC TECHNICIANS

INSTRUMENTATION TECHNICIANS

Must be experienced in the maintenance and repair of electronic test equipment. Excellent opportunity for permanent first and second shift positions with AAA standing profit-sharing program. Male and female.

RESEARCH TECHNICIANS

Excellent opportunity for men exp

WANTED: half a million

RCA HOME TRAINING CAN PREPARE YOU FOR THE BIGGEST CAREER OPPORTUNITIES IN HISTORY! NEW 'CAREER PROGRAMS' POINT THE WAY!

Electronics Jobs Expanding Every Day; Trained Technicians in Demand; RCA Institutes "Space Age" Methods make learning faster, easier!

Government reports have indicated the increasing demands for manpower in the electronics fields.* New developments in modern technology, automation, the growth of new areas of work, such as atomic energy, earth satellites and other space programs, and systems analysis and processing are changing the occupational picture daily. To help meet this need, RCA Institutes offers a wide variety of Home Training Courses, all geared to a profitable, exciting electronics career in the shortest possible time.

New Career Programs right on target

RCA Institutes new "Career Programs" are complete units that train you for the specific job you want. And each of them starts with the amazing "AUTOTEXT" Programmed Instruction Method—the new scientific way to learn. RCA "AUTOTEXT" helps even those who have had trouble with ordinary home training methods in the past. Learn faster and easier than ever before!

Valuable Equipment Included

With each RCA Institutes Career Program, you receive valuable equipment to keep and use on the job. You'll get the new Programmed Electronics Breadboard which provides limitless

laboratory type experimentation, from which you construct a working signal generator and a superheterodyne AM Receiver. And as a special bonus, you get valuable Multimeter and Oscilloscope Kits—all at no additional cost!

Liberal Tuition Plan Ideal for Today's Budgets

RCA Institutes offers you this most economical way to learn. You pay for lessons only as you order them. No long term contracts. You can stop your training at any time and you will not owe one cent! Compare this with any other home training plan!

Choose from these Job-Directed Programs.

- TELEVISION SERVICING
- FCC LICENSE PREPARATION
- AUTOMATION ELECTRONICS
- AUTOMATIC CONTROLS
- DIGITAL TECHNIQUES
- TELECOMMUNICATIONS
- INDUSTRIAL ELECTRONICS
- NUCLEAR INSTRUMENTATION
- SOLID STATE ELECTRONICS
- ELECTRONICS DRAFTING
- plus a wide variety of separate courses from Electronics Fundamentals to Computer Programming.

technicians!

CLASSROOM TRAINING ALSO AVAILABLE

You may also learn electronics at one of the most modern laboratory and classroom electronics schools in the country—RCA Institutes Resident School in New York City. Day and Evening Courses start four times a year—and courses are planned so as not to interfere with your job or social life. No previous technical training needed for admission. You are eligible even if you haven't completed high school.

SEND NOW FOR NEW VALUABLE FREE CAREER BOOK—YOURS WITHOUT COST OR OBLIGATION. SEND POSTAGE PAID CARD TODAY. CHECK HOME TRAINING OR CLASSROOM TRAINING.

Free Placement Service For all Students

Recently, RCA Institutes Free Placement Service has placed 9 out of 10 Resident School graduates in jobs before or shortly after graduation! And, many of these jobs are with top companies—like IBM, Bell Telephone Labs, General Electric, RCA, and radio and TV stations throughout the country. This service is now available to Home Study students as well.

RCA INSTITUTES, Inc. Dept. ZRE.16

350 West 4th St., New York, N. Y. 10014

A Service of Radio Corporation of America



The Most Trusted Name in Electronics

*"Scientists, Engineers, and Technicians in the 1960's" U.S. Dept. of Labor Bureau of Labor Statistics, 1964.

Circle 21 on reader's service card

EQUIPMENT REPORT

RCA WR-64B Color-Bar/ Dot/Crosshatch Generator

Circle 22 on reader's service card



RCA's WR-64B color-bar/dot/cross-hatch generator is the latest in their attractive look-alike line of test equipment. However, it's all new and different inside.

The 189-kc crystal oscillator starts the countdown. From 189 kc, dividers manufacture 31.5, 15.75 and 4.5 kc, then 900, 180 and finally 60 cycles.

A highly accurate rf carrier is very important in color work. The WR-64B uses a channel 3 crystal, with another 4.5-mc crystal oscillator giving an accurately spaced sound carrier. The sound carrier can be switched off after the fine tuning of the TV set is adjusted. A channel 4 crystal can be substituted, if you'd rather.

Although the 4.5-mc carrier is referred to as the "sound", it's unmodulated. But without it, you'll hear the squawking and buzzing of the pattern signals in the speaker; turning on the sound carrier quiets this. It should be turned off after the fine-tuning has been set up.

For color bar signals, a 3.563795-mc crystal oscillator is used. Fed into the receiver, this gives a 15,750-cycle

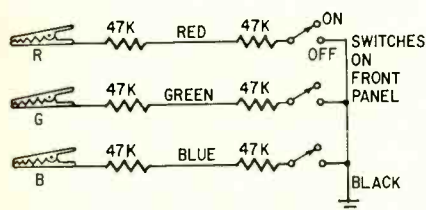

Gun-killer assembly. Circuit is unusual in that, instead of single 100,000-ohm isolating resistor for each grid, two 47,000-ohm resistors are used. This, according to the manufacturer, reduces capacitive loading by the cables on the grids.

beat with the 3.579545-mc oscillator in the set, or one scanning line. So, we get a full 360° "swing" during each line, going through the whole range of colors. This gives us the rainbow pattern on the screen: maximum red at left, blue in the center and green at right.

By squaring and shaping the 189-kc output, we get pulses; these are used to gate the rainbow signal into ten color-bar signals, accurately spaced at 30° phase intervals. Very narrow brightness (Y) pulses are added at the edges to check the fit of the color signals against the brightness.

This instrument makes exceedingly small dots and a very fine-line cross-hatch pattern. I'm a crosshatch man myself, but if you like dots, they're here. Both patterns are most exceedingly stable; in fact, the stability of the whole instrument is very good, including the rf carriers. We gave it a very exhaustive check against a channel 3 TV signal. It came on right on the nose each time and stayed there. This is a very useful thing in field work.

The WR-64B, from a cold start, comes on locked in. One of my favorite tests, that one, and one that was passed with flying colors. (That's a very bad simile, for what I mean is that the generator came on with color bars locked in place every time.)

The ten color bars include R — Y, B — Y, G — Y, I and Q signals (in both polarities, of course). The sine-wave output of the color circuit has maximum amplitude at 90° in the R — Y demodulator, 180° in the B — Y demodulator, and about 300° in the G — Y demodulator. Out of curiosity, I traced the signals through the demods of a CTC9 RCA chassis, and found patterns just like in the book. Pulses, bars and sync are all very clean and sharp. This makes troubleshooting defects in color circuits a lot easier.

The rf output cable is permanently attached to the back panel, terminated in a 300-ohm pad enclosed in RCA's familiar "hairy egg" with two "hot" clips and a ground clip. Another four-wire cable comes out the back for the gun-killer switches. Color-coded alligator clips, with insulation-piercing teeth in the jaws, can be attached to the grid wires of the CRT without taking the socket off.

This is something I like better every time I use it for convergence. Since they started using the combination-red-green circuits, you can get much faster results by killing the blue gun, working up a good yellow pattern, and then overlaying the blue with its controls.

A handy bracket for winding up

the cables is fastened to the back panel, but can be taken off if you use the WR-64B for shop work only. A very well written instruction book comes with the instrument, giving full details on how to use it, plus valuable tips for servicing. Counters can be easily adjusted with a low-capacitance probe and scope. Test points are provided just inside the tube-access panel door on the back; you don't have to take the chassis out of the case to reset any counters.

One trouble I ran into on this generator, as on many similar ones: There is no control over the rf output amplitude. If the set you're working on has been used in a fringe area, the agc may be set too "hot", and you'll get an agc blackout when you feed the strong rf output of a bar-dot gen into it. This is a common cause of instability complaints, in patterns! Remember to reset the agc to deal with the high signal input (also to reset it for weaker signals when you take the set home!).

Price: \$189.50

Sencore CG135 All-Transistor Deluxe Color-Bar Generator

Circle 23 on reader's service card

INSTANT COFFEE, INSTANT TEA, AND now instant color bars. The Sencore CG135 color-bar/dot/crosshatch generator is all-transistor, and starts in a hurry. Actually it isn't really instant; it takes almost a *second and a half* (actually timed!) to display a pattern! (Tsk-tsk.) Ac-powered, this instrument uses a total of 23 transistors, three diodes and two silicon rectifiers.

The CG135 uses the crystal-countdown circuit, by now almost standard. A crystal oscillator at 189 kc in a Pierce circuit with a 2N1304 is the starting point. All other signals are derived from it, except the color and sound. A 2N404 is a buffer-shaper, feeding the 189-kc signal to a series of six unijunction transistors (2N2646's) in the "timer" countdown stages. The sequence is 31.5 kc, 15,750 cycles, 6,300, 900, 180 and 60 cycles. All divider circuits are identical for part values.

The 189-kc signal, clipped and shaped, makes vertical lines; the 900-cycle signal makes the horizontal lines. Both are fed into the mixer to get a crosshatch. To give the dot pattern, the mixer diode is biased so that it conducts only when *both* signals are present. The 15,750 and 60-cycle signals are fed into a sync-former stage. The output of this, together with the bar, dot, color and crosshatch signals, goes to the series-diode rf modulator.

The rf oscillator is a Colpitts, tunable from channel 3 through channel 5.

An internal control can change modulation percentage, if needed. A 4.5-mc crystal oscillator provides an unmodulated sound carrier, also fed into the modulator, which can be switched on or off as desired.

A color control has a range of "0 to 200%." For sets with color sync troubles, the extra output can be used to hold color until the trouble can be pinned down.



Composite video output, of either positive or negative polarity, 2 volts peak-to-peak, can be picked up at a panel jack on the CG135. This is for tracing trouble by injecting a video signal at the video-amplifier input. All patterns, plus color bars, can be used with this output. In addition, a separate COMPOSITE SYNC (only) output is provided, for use with Zenith receivers having the separate sync detector ahead of the video detector. When injecting a video signal at the detector output, it is necessary to have sync fed into this sync-detector input, to get a locked picture. This is -2 volts p-p in amplitude.

A very handy color-gun interrupter is furnished. Three test leads have color-coded alligator clips with insulation-piercing needles inside the jaws. These are clipped to the CRT grid leads at the socket, and go to ground through slide switches on the CG135's panel. A 100,000-ohm resistor is mounted at each clip for isolation. This is an appealing feature, at least for me. By cutting the blue out and working on the R - G controls, badly misconverged sets can be straightened up in much less time.

This is a very stable instrument. I checked it on a thoroughly warmed-up color set, tuned to a color program, with all set controls adjusted properly. From a cold start, a locked color bar pattern will show up in about 1.5 seconds. The same with the bar, dot and crosshatch patterns. No crawl or jitter was found on cold-start or long-run tests.

The CG135 is a real compact: 8 pounds, 9½ by 10¼ by 4 inches. Takes up much less room on top of the set, and

you can see the convergence board over it if you have to. A real, wrinkle-free glass mirror, protected by a foam-plastic pad for traveling, is thoughtfully fastened to the inside of the lid. Sencore's customary test-lead storage compartment at the bottom of the front panel holds all the leads, line cords, etc., with plenty of room; no dangling cables.

It doesn't seem that there would be much trouble with this instrument, but if there is, the timer has adjustable controls. These are accessible by removing the front panel. A well written instruction book is furnished, and the troubleshooting chart and full schematic will help if disaster should strike!

Price: \$146.95

AR-2a^x Speaker System

Circle 24 on reader's service card

ACOUSTIC RESEARCH IS ONE FIRM THAT has never been guilty of resting on its laurels. Each of its products has undergone constant scrutiny and, when possible, been updated. That is the case with this new (but really not new) AR-2a^x.

The ^x designation is the clue. This is a modification of the AR-2a, a three-way acoustic-suspension system that has been a mainstay of the AR line for some years. The AR-2a was, and is, a fine speaker. However, it did suffer somewhat from mid-range weaknesses. The range between that covered by the woofer and tweeter was somehow not in keeping with the very high standards set at both ends of the frequency spectrum.

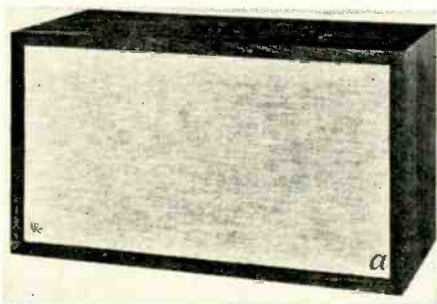

By way of review, the original AR-2a was an outgrowth of a still earlier speaker, the AR-2. This was (and as an AR-2^x still is) a fine, low-cost two-way system. It uses a 10-inch acoustic-suspension woofer and two cross-fired 5-inch tweeters. These components were installed in a cabinet 2 feet long and a foot wide and deep. The AR-2a, sharing the same cabinet, was born as a result of AR's deluxe AR-3. The "fried-egg" dome tweeter of the AR-3 was added, with appropriate crossover changes, to the AR-2. The result was the AR-2a—the 10-inch woofer, the dual cross-fired units, now as mid-range, and the little egg yolk as a tweeter.

This speaker has enjoyed wide suc-

continued on page 70

for successful COLOR TV servicing

own these SAMS BOOKS



Color TV Training Manual, New Second Edition

by C. P. Oliphant & Verne M. Ray. This newly revised comprehensive manual is the most up-to-date guide available for technicians preparing to service color TV receivers. Full information on: Colorimetry; Requirements of the Composite Color Signal; Make-up of the Color Picture Signal; RF and IF Circuits; Video, Sync & Voltage-Supply Circuits; Bandpass Amplifier, Color-Sync and Color-Killer Circuits; Color Demodulation; Matrix Section; Color Picture Tube & Associated Circuits; Setup Procedure; Aligning the Color Receiver; Troubleshooting. Includes full-color illustrations invaluable for setup, alignment, and troubleshooting. 224 pages; 8½ x 11". \$5.95
Order TVC-2, only.

Color TV Servicing Made Easy

by Wayne Lemons. Written in "made easy" style. Takes the mystery out of color TV servicing. Familiarizes you with color principles and setup adjustments; thoroughly covers color circuitry, adjustments, and servicing of all color TV sets produced to date. This book will help to put you into this fast-growing, profitable service work. 128 pages; 5½ x 8½". Order CSL-1, only. \$2.50

Know Your Color-TV Test Equipment

by Robert G. Middleton. Explains clearly and easily the function and circuit action of each color TV test instrument. Covers: White-Dot and Cross-Hatch Generators, Color-Pattern and Color-Bar Generators, Rainbow and NTSC Generators, Principles of Video-Frequency Sweep Generators and Testing. Lab-type equipment, and valuable setup information. Profusely illustrated. 160 pages; 5½ x 8½". Order KOC-1, only. \$2.50

Color TV Trouble Clues

Invaluable field-tested guide to trouble clues and procedures for color TV receiver repair. Describes types of troubles encountered, troubleshooting techniques, alignment and sync problems, convergence, etc. Includes data on use of test equipment to speed color TV servicing. Fully illustrated with photographs and schematics. A "must" for color TV service technicians. 96 pages; 5½ x 8½". \$1.95
Order COL-1, only.

101 Ways to Use Your Color TV Test Equipment

by Robert G. Middleton. Written in the time-tested formula acclaimed by thousands of TV technicians. Shows you practical uses for your test equipment to diagnose color TV circuit troubles quickly and easily. Describes proper equipment hookups, how to evaluate test results, how to check instruments; includes time-saving techniques. 144 pages; 5½ x 8½". Order TEM-9, only. \$2.50

Color TV Guidebook

A special Howard W. Sams publication about color TV servicing techniques, equipment required, and related subjects. General information includes outlook for color TV manufacturers, broadcasting networks, and technicians. Specific sections deal with starting a color TV service business, troubleshooting and repair techniques, antennas, color tube stocking, transistorized color TV, small-town color TV problems, new circuits and developments. \$1.00
8½ x 11". Order PFR-1, only.

HOWARD W. SAMS & CO., INC.

Order from your Sams Distributor today, or mail to Howard W. Sams & Co., Inc., Dept. RE-1
4300 W. 62nd Street, Indianapolis, Ind. 46206

Send me the following books:

- TVC-2 KOC-1 TEM-9
 CSL-1 COL-1 PFR-1

Send FREE Sams Booklist. \$_____ enclosed

Name _____

Address _____

City _____ State _____ Zip _____

My Distributor is _____

Circle 26 on reader's service card

How To Have Fun While You Save . . .

Something For Everyone . . . In This Vast Heathkit Selection!

Kit GR-43
\$159⁹⁵

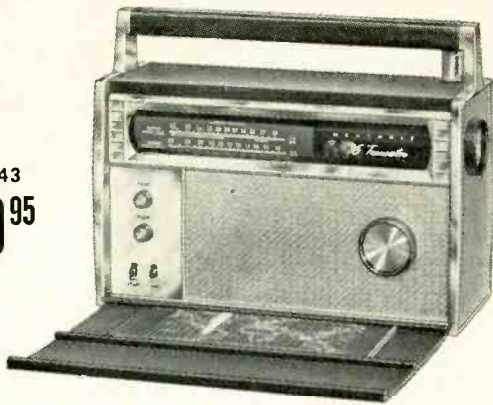

New Heathkit 10-Band Transistor Portable!

10 bands tune Longwave, Standard Broadcast, FM and 2-22.5 mc Shortwave. 16 transistors, 6 diodes, and 44 factory assembled and pretuned circuits. Two separate AM & FM tuners and IF strips. FM tuner & IF strip are same components used in deluxe Heathkit FM stereo gear. 2 built-in antennas. Battery saver switch cuts current drain up to 35%. Rotating tuning dial. Dial light. 4 simple controls for tuning, volume, tone, AFC and band switching. 4" x 6" PM speaker. Earphone & built-in jack. Optional 117 v. AC converter/battery charger available @ \$6.95. Time zone map & "listener's guide." Man size: 13½" W x 5½" D x 10½" H. 17 lbs.

Kit GW-14
\$89⁹⁵

Assembled GWW-14
\$124⁹⁵

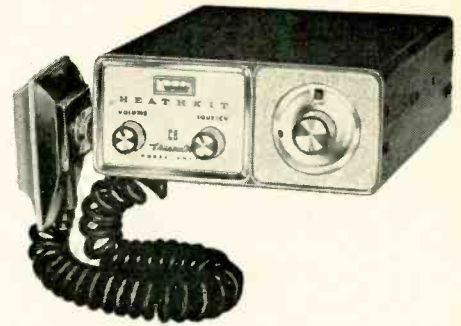

New 23-Channel, 5-Watt, Transistor CB Transceiver!

Your best 23-channel CB buy—bar none! Compare! 23 crystal-controlled transmit & receive channels for the utmost reliability . . . at lowest cost. All-transistor circuit for instant operation, low battery drain . . . only .75 A transmit, .12 A receive. Compact . . . 3" H x 7" W x 10½" D . . . ideal for car, boat, and 12 v. neg. gnd. mobile use. ½ uv sensitivity for 10 db signal plus noise-to-noise ratio. Includes "S" meter, adjustable squelch, automatic noise limiter, built-in speaker, ceramic PTT mike, gimbal mounting bracket, aluminum cabinet with die-cast chrome-plated front panel. 8 lbs. Kit GWA-14-1, optional power supply for AC operation, 5 lbs. . . \$14.95. GWA-14-2, complete 23 channel crystal package (46 CB crystals)—\$135.70 value. . . only \$79.95

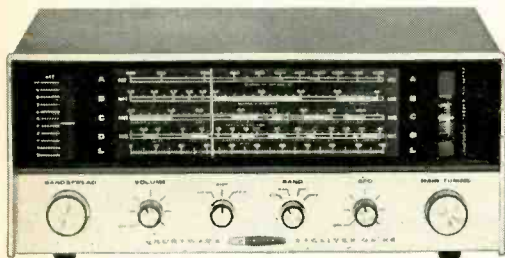

Kit GR-64
\$37⁹⁵

Enjoy World-Wide Listening With This Low-Cost Shortwave Receiver!

Hear live broadcasts from hundreds of foreign countries, Voice of America, Radio Moscow, hams, ship-to-shore radio, weather and popular AM. Covers 550 kc to 30 mc—includes AM plus 3 shortwave bands; 5" speaker; bandspread tuning; signal strength indicator; 7" sliderule dial; BFO; 4-tube circuit plus 2 rectifiers; noise limiter; external antenna connectors; gray aluminum cabinet; AM antenna; 15 lbs.



Kit SB-100
\$360⁰⁰

New DeLuxe 5-Band SSB Ham Transceiver

Full SSB-CW transceive operation on 80-10 meters. 180 watts PEP SSB—170 watts CW. Switch select for USB/LSB/CW operation. Operates PTT and VOX; VOX operated CW with built-in sidetone. Triple Action Level Control™ allows greater variation in speech level. Heath SB series Linear Master Oscillator (LMO) for true linear tuning. Mobile or fixed operation with appropriate power supply. 23 lbs. Accessory mobile mount, SBA-100-1 \$14.95.

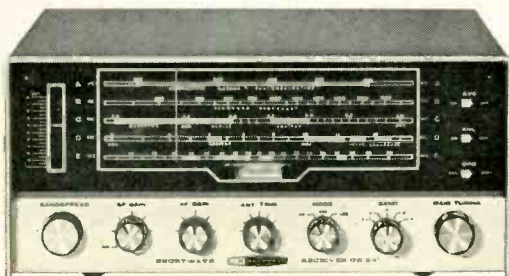

New Deluxe Shortwave Radio

Compare it to sets costing \$150 and more! 5 bands cover 200-400 kc, AM, and 2-30 mc. Tuned RF stage, crystal filter for greater selectivity, 2 detectors for AM and SSB, tuning meter, bandspread tuning, code practice monitor, automatic noise limiter, automatic volume control, antenna trimmer, built-in 4" x 6" speaker, headphone jack, gray metal cabinet, and free SWL antenna. 25 lbs.

Kit GR-54
\$84⁹⁵



Kit HD-10
\$39⁹⁵

New Heathkit Solid-State Electronic Keyer

All solid-state circuitry. Speed range—15 to 60 words per minute. Solid-state switching—no relays to stick or clatter. Adaptable to either right or left handed operators. Convertible to semi-automatic operation. Variable dot-space ratio. Self-completing dashes. Sealed switches on paddle—no exposed contacts to clean or adjust. Built-in paddle—"feel" is adjustable to your fist during assembly. "Hold" switch for transmitter tuning. Transformer-operated power supply isolates keyer from line power. Fused for protection. 6 lbs.

... Build A Heathkit®!

Now Choose From 2 Heathkit® Transistor Stereo Receivers!

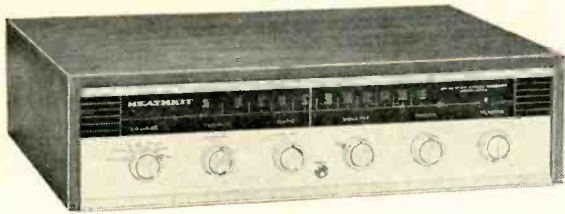

New 30-Watt Transistor FM Stereo Receiver . . . Less Than \$100!

Features 31 transistors, 11 diodes for cool, natural transistor sound; 20 watts RMS, 30 watts IHF music power @ ±1 db, 15 to 60,000 cps; wideband FM/FM stereo tuner plus two preamplifiers & two power amplifiers; front panel stereo headphone jack; compact 3 3/4" H x 15 1/4" W x 12" D size. Assembles in 20 hours or less. Custom mount it in a wall, or optional Heath cabinets (walnut \$9.95, beige metal \$3.95) 16 lbs.

Kit AR-14
\$99⁹⁵
(less cabinet)



66-Watt Transistor AM/FM Stereo Receiver

Just add 2 speakers for a complete stereo system. Boasts AM/FM/FM Stereo tuning; 46-transistor, 17-diode circuit for cool, instant operation and natural transistor sound; 66 watts IHF music power (40 watts RMS) at ±1 db from 15 to 30,000 cps; automatic switching to stereo; preassembled & aligned "front-end" & AM-FM IF strip; walnut cab. 35 lbs.

Kit AR-13A
Now Only
\$184⁰⁰

Best Hi-Fi News Of '66 . . . New Low-Cost Transistor Stereo Twins!

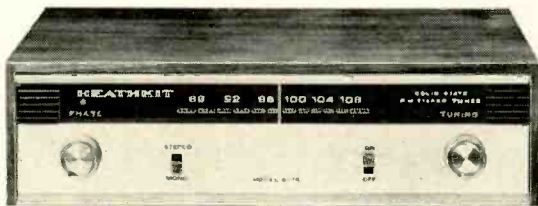

New Transistor FM/FM Stereo Tuner

Heath's easiest to build stereo/hi-fi kit . . . takes only 4 to 6 hours! 14 transistor, 5 diode circuit for cool instant operation, transparent transistor sound. Phase control assures best stereo performance. 3 transistor "front-end" plus 4-stage IF section. Filtered outputs for direct stereo recording. Automatic stereo indicator light. Preassembled & aligned "front-end." Install in a wall or either Heath cabinet (walnut \$7.95, beige metal \$3.50). 6 lbs.

Kit AJ-14
\$49⁹⁵
(less cabinet)

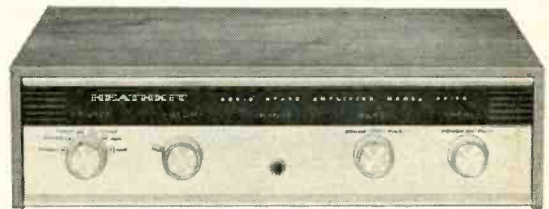

Matching 30-Watt Transistor Stereo Amplifier

Assembles in 10 hours or less! 17 transistors, 6 diodes. 20 watts RMS, 30 watts IHF music power @ ±1 db, 15 to 60,000 cps. No audio transformers . . . assures minimum phase shift, extended response, lower distortion. Solid-state power supply plus electronic filter for regulation within 10%. Accommodates phono, tuner, auxiliary . . . 4, 8, 16 ohm speaker impedances. Lighted panel. Installs in wall, or Heath cabinets (walnut \$7.95, metal \$3.50). 10 lbs.

Kit AA-14
\$59⁹⁵
(less cabinet)

— Buy Now—Use This Order Blank—

NEW 1966 CATALOG!



Free! 108 pages . . . many in full color . . . describe these and over 250 easy-to-build Heathkits. Save up to 50%. Mail coupon for your free copy.

Heath Company, Dept. 20-1
Benton Harbor, Michigan 49023



Please send FREE Heathkit Catalog

Model	Description	Weight	Price

Name _____ (Please Print)

Address _____

City _____ State _____ Zip _____

SHIP VIA:

Parcel Post Express Collect Freight 20% Included, C.O.D. Best Way
All prices & specifications subject to change without notice.

CL-232

Circle 27 on reader's service card

cess both with the critics and on the sales floor. If those dual tweeters-turned-mid-range were less smooth and transparent than they should have been, the AR-2a was still a highly competitive speaker within its price range.

This AR-2a^x has done away with the dual 5's, replacing them instead with a single broad-dispersion 3½-inch unit.

I have always felt that the old AR-2a suffered particularly from a mid-range that was depressed in amplitude. Even at the maximum rear-panel control setting, the mid-range output was still low compared to the woofer and tweeter. The tweeter, with its own level control, could, of course, be toned down to match the mid-range; both would now be low relative to the fixed woofer. The result of this action was a speaker with a certain hollow quality—more so in heavily padded rooms, but even in highly live rooms that in themselves tend to boost mid-range output. This weakness is gone in the ^x version.

The mid and high drivers still have individual controls on the rear of the cabinet. I found, in a rather live-sounding listening room, that it was still necessary to *raise* the mid-range output slightly above AR's suggested normal setting, but the tweeter was best a slight bit below their mark.

The AR-2a^x emerges as a very smooth 8-ohm speaker capable of delivering a very wide-range sound. There is good bass response to the 40-cycle region. Frequency sweeps upward show no bumps or dips of consequence.

The new mid-range also seems to have made significant improvement in the transient-response capabilities of the speaker. This is now a highly transparent speaker, able to do justice to the most complex musical material.

Best of all, the AR-2a^x is offered at no price increase over its immediate predecessor. Oiled or polished walnut is still \$128; other finishes are available at the same or lower prices. It needs a good 20-watt, or bigger, amplifier (each channel) and it deserves a good program source.

Price: \$128, oiled walnut; \$109, unfinished pine

BUILD AN ULTRASENSITIVE LIGHT METER

This electronics writer-hobbyist-photographer wanted a simple, extremely sensitive light meter for fine closeup photographs of miniature parts and wiring. He built his own! You can too, for less than \$10! See it on the cover next month!

Coming in February
RADIO-ELECTRONICS

Garrard Lab 80 Automatic Turntable

Circle 25 on reader's service card

GARRARD HAS, FOR YEARS, USED A pusher-platform type of changing mechanism in its top-of-the-line changer. The Lab 80 uses a single long spindle with three extendable arms that hold up the record stack. At the critical moment, the three arms contract, while a collar expands. The collar grabs all of the records except the bottom one, holding them securely by their center holes. The bottom disc, with no hold on it, falls gently to the turntable. Obviously, there is no abrasion of the bottom disc against the one above as was the case with pusher systems.

The tone arm is a long and graceful wooden structure—at least so it appears. It is long and it is graceful—but it is not *all* wood. Rather, it is a bonding of wood to an aluminum structure, for



great rigidity and strength. The wood in the arm is not merely decorative. It is lightweight, relatively rigid and tends to damp normal arm resonances.

The Lab 80 arm is of *static balance* design. A rear weight is adjusted to balance the arm and cartridge, and then spring pressure is applied to provide the proper tracking force. This popular system is stable and isn't quite so critical about non-level locations. (This is the type of arm that can track upside down.)

The counterweight of the Lab 80 has continuous click-stops as it screws in and out for balance. This makes it easy to obtain hair-perfect balance. Once the arm is balanced, stylus force is dialed on a knurled knob under the arm. This, too, has click-stops. Each click represents an exact force change of ¼ gram.

A basic law of physics states essentially that any pivoted arm with an offset head will glide toward the center of rotation when the head is placed on a revolving disc. This is *skating*—the force that tends to pull the arm to the record's center. With stereo discs, where there is different information on each side wall of the groove, skating pull (even if it isn't enough to yank the stylus from the groove) can cause distortion in the outer-wall channel because the stylus is

pulled away from intimate contact.

Located near the base of the Lab 80's arm pivot, an adjustable *anti-skating counterweight* pushes against the arm to equalize the pressures.

Four levers operate the Lab 80. The first (from the left) is for speed selection: 33⅓ or 45 rpm. The second and third levers set the unit in operation as either a manual or automatic player. The manual control does one other thing: it activates an *arm cue* mechanism. This allows you to position the arm manually *over* any point on the record. Then you depress a lever in the arm rest stand and the arm will float gently down to the record. Once it has done its job, the device becomes completely disengaged from the arm. It's great; it ends butterfingering fumbling.

The final front-panel lever selects the record size for automatic play. The Lab 80 will not intermix different diameters or speeds of discs. So, for automatic play, you set the control to 12-, 10- or 7-inch and pull the next-to-last lever to AUTO. The Lab 80 does the rest.

One expected feature I found *missing* was the ability to play a single record automatically with the short spindle in place. You must position the arm manually (with the cue system). The arm will still pick up automatically at the end of play, or if you activate the AUTO lever.

Performance was consistent and reliable. There was no jamming. Construction seems sound enough for long, trouble-free service.

Rumble and flutter/wow measurements are the two prime barometers of a turntable's qualities. The rumble on our sample was 33 db below a 3.54-cm/sec recorded signal. Much of this rumble was centered around 60 cycles. The practical result is that the Lab 80 had some audible rumble when a stereo record was played at high volume settings. This was not judged objectionable.

Flutter and wow measurements showed the Lab 80 up as top-notch. Total flutter was .08% and total wow 0.15%. These figures compare very favorably with the best manual tables. By ear, even *piano tone*, the toughest test of all, gave no *indication* of warble or wow.

The arm will track at 0.25 gram, if you can find a cartridge that will. However, the trip mechanism required 0.4 gram minimum for activation. Either figure is well below the lower force limit of even the best cartridges and the Lab 80 may be used with the highest-compliance, so-called "manual play" cartridges.

Arm resonances were centered at 20 cycles—well below the point where trouble might be caused. Tracking error was also low, never over 1% when used with a standard-mount cartridge.

—Leonard Silke

END

Price: \$99.50 (plus \$3.95 for optional walnut base)

Most People Build Heathkit® Test Gear . . .



But Many Buy Them Factory Assembled!

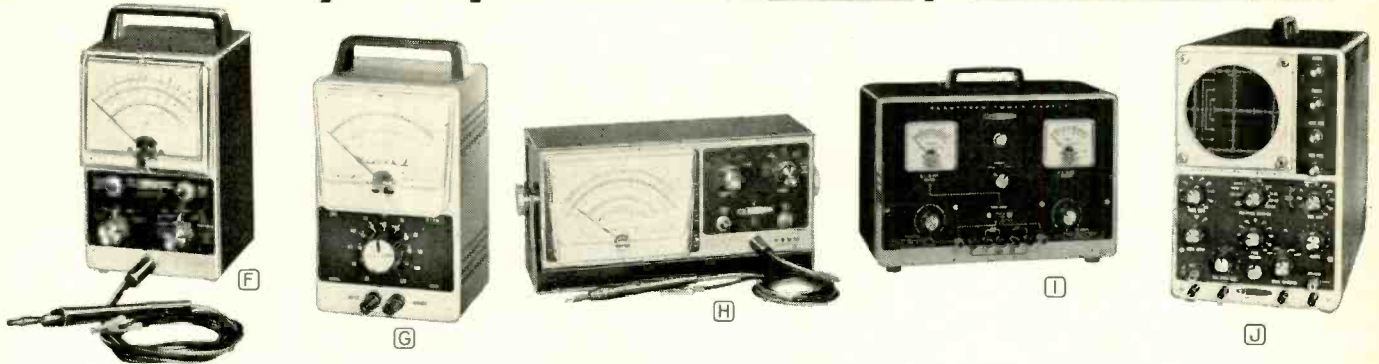

Either Way, These 10 Are Best Buys

A RF Signal Generator . . . Countless Applications In Radio & TV Servicing! Covers 100 kc to 220 mc in 6 bands; large accurately calibrated dial scales; modulated or unmodulated RF output; 400 cps signal for audio tests. 6 lbs.

Kit IG-102 \$27.95
Assembled IGW-102 \$54.95

B Switch-Selected Audio Frequency Generator. Produces near-perfect sine waves; switch-selected output frequencies—10 cps to 100 kcs; less than 0.1 of 1% distortion—20-20,000 cps; calibrated in volts & db; accuracy within $\pm 5\%$. 8 lbs.

Kit IG-72 \$41.95
Assembled IGW-72 \$64.95

C Deluxe Capacitor Checker . . . A Direct-Reading Bridge. Tests all capacitor types; low-bridge voltage for testing miniature electrolytics; 16 leakage test voltages; direct reading scale measures resistance from 5 ohms to 50 megohms; measures 10 uuf to 1000 mfd, L, C, or R. 9 lbs.

Kit IT-11 \$29.95
Assembled ITW-11 \$49.95

D Solid-State Regulated DC Power Supply 50 MA, 150 MA, 500 MA, & 1.5 A current ranges; 5, 15, 50 v. DC voltage ranges; fil-

tered output for less than 150 uv ripple; adjustable current limiter, 30 to 100% on each range. 16 lbs.

Kit IP-20 \$72.95
Assembled IPW-20 \$114.95

E "Low-Ripple" Battery Eliminator. Switch selection of 6 or 12 v. DC power; special filter circuit holds AC ripple to less than 0.3%; metered output voltage & current; doubles as a battery charge. 21 lbs.

Kit IP-12 \$47.50
Assembled IPW-12 \$59.95

F World's Largest Selling VTVM. Single AC/Ohms/DC probe; 7 AC/DC/Ohms ranges; 1% precision resistors for high accuracy; frequency response ± 1 db from 25 cps to 1 mc; voltage doubler rectifier; $4\frac{1}{2}$ ", 200 UA meter. 5 lbs.

Kit IM-11 \$24.95
Assembled IMW-11 \$39.95

G Laboratory AC VTVM . . . 10 Voltage Ranges! Covers 0.01 to 300 volts RMS full scale in 10 voltage ranges with 5% accuracy; frequency response ± 1 db from 10 cps to 500 kc; 10 megohm input impedance for high accuracy; calibrated db scale for audio measurements. 5 lbs.

Kit IM-21 \$39.95
Assembled IMW-21 \$52.95

H Deluxe "Service Bench" VTVM. 7 AC/DC/Ohms ranges; measures AC volts (RMS), DC volts, resistance & db; separate 1.5 & 5 volt AC scales; gimbal mount for bench, shelf, or wall; 6", 200 UA meter; single AC/Ohms/DC probe; smooth vernier controls for zero & ohms adjust. 8 lbs.

Kit IM-13 \$32.95
Assembled IMW-13 \$49.95

I Variable-Voltage Regulated Power Supply. Furnishes B+, bias & filament voltages; DC output variable from 0 to 400 volts; separate panel meters for voltage & current; output terminals isolated for safe AC/DC work. 17 lbs.

Kit IP-32 \$56.95
Assembled IPW-32 \$84.95

J Extra-Duty Wide-Band 5" Oscilloscope. Full 5 mc bandwidth for color TV servicing; Heath patented sweep circuit 10 cps to 500 kc, push-pull vertical & horizontal amplifiers; positive trace position controls; peak-to-peak calibration reference; Z-axis input. 24 lbs.

Kit IO-12 \$76.95
Assembled IOW-12 \$126.95



FREE HEATHKIT® CATALOG!

Packed with over 250 Heathkits including complete Test Instrument line. Save up to 50%. Mail coupon, or write Heath Company, Benton Harbor, Michigan 49023 for your Free copy.



Use To Order And/Or Get FREE Catalog

Heath Company, Dept. 20-1, Benton Harbor, Michigan 49023

Please send FREE 1966 Heathkit Catalog.

Enclosed is \$ _____, plus shipping.

Please send model(s) _____.

Name _____

Address _____

City _____ State _____ Zip _____

Ship Via: Parcel Post Express Collect

Freight 20% Included, C.O.D. Best Way

TE-140

Prices and specifications subject to change without notice.

The following free advertising material is available through

RADIO-ELECTRONICS READER'S SERVICE

ALLIED RADIO CORP. (Pg. 90-93) 1966 Catalog.	Circle 124
AMPEREX (Second Cover) List of tubes.	Circle 1
BRACH MFG. CORP. (Pg. 78) Catalog on antennas.	Circle 112
BROOKS RADIO & TV CORP. (Pg. 98-99) Catalog sheets and price lists of tubes and parts.	Circle 130
BURSTEIN-APPLEBEE (Pg. 80) Catalog.	Circle 115
CASTLE TV TUNER SERVICE (Pg. 6) Information on complete tuner overhaul by mail.	Circle 5
CLEVELAND INSTITUTE OF ELECTRONICS (Pg. 77) Electronics slide rule Booklet and data guide.	Circle 109
CONAR INSTRUMENTS (Pg. 22) Catalog on kits.	Circle 11
CORNELL ELECTRONICS, INC. (Pg. 105) Catalog and price list of tubes and parts.	Circle 138
COYNE ELECTRONICS INSTITUTE (Pg. 102) Booklet: "Your Opportunities in Electronics".	Circle 133
DATAK CORP. (Pg. 84) Folder and sample of "Instant Lettering".	Circle 118
DE VRY TECHNICAL INSTITUTE (Pg. 5) Booklets "Pocket Guide to Real Earnings" & "Electronics in Space Travel".	Circle 4
EASTMAN KODAK (Pg. 7) 24-Page booklet "Plain Talk" on Tape performance.	Circle 6
ELECTRONIC COMPONENTS CO. (Pg. 106) Information on Rectifiers & Transistors.	Circle 137
FINNEY CO. (Third Cover) Booklets on Color Ve-Log Antennas.	Circle 141
GARRARD (Pg. 14) Comparator guide on Lab 80 record changer.	Circle 7
GRANTHAM SCHOOL OF ELECTRONICS (Pg. 102) Catalog.	Circle 134
HEALD'S ENGINEERING COLLEGE (Pg. 101) Catalog and registration application.	Circle 132
HEATH COMPANY (Pg. 68, 69, 71) Catalog.	Circle 27
INTERNATIONAL CRYSTAL MFG. CO. (Pg. 1) Information on Model MO Transceiver for Citizens Radio Service.	Circle 2
INTERNATIONAL RADIO EXCHANGE (Pg. 79) List of equipment in stock.	Circle 114
JERROLD ELECTRONICS CORP. (Pg. 86) Information on the Pathfinder TV and FM antennas.	Circle 122
JFD ELECTRONICS CORPORATION (Pg. 32) Information on LPV Color Log Periodic Antennas.	Circle 18
LECTROTECH, INC. (Pg. 97) Catalog on test equipment.	Circle 129
MERCURY ELECTRONICS CORP. (Pg. 16) Catalog on test equipment.	Circle 9
MILWAUKEE SCHOOL OF ENGINEERING (Pg. 102) Booklet: "Your Career".	Circle 135
OLSON ELECTRONICS, INC. (Pg. 101) Catalog.	Circle 131
PERMA-POWER CO. (Pg. 75) Information on Color-Brite brighteners.	Circle 106
POLY PAKS, INC. (Pg. 107) Catalog of semiconductors.	Circle 139
PRECISE ELECTRONICS & DEVELOPMENT (Pg. 2) Information on test instruments.	Circle 3
QUAM-NICHOLS CO. (Pg. 24) Information on color TV replacement speakers.	Circle 13
RCA INSTITUTES (Pg. 62-65) Brochure on home study and classroom study.	Circle 21
RCA TEST INSTRUMENTS (Pg. 23) Information on RCA WR-64B color Bar/Dot/Crosshatch generator.	Circle 12
READING IMPROVEMENT PROGRAM (Pg. 79) Booklet: "Adventures in Reading Improvement".	Circle 113
RADIO SHACK (Pg. 108) Catalog.	Circle 140
SAMS, HOWARD W. CO. INC. (Pg. 17) 1966 Photofact Annual Index and information on Encyclopedia offer.	Circle 10
SAMS, HOWARD W. CO. INC. (Pg. 67) Booklist.	Circle 26
SCOTT, H. H. (Pg. 77) Spec sheet on solid-state stereo amplifier kit.	Circle 108
SECO ELECTRONICS CORP. (Pg. 81) Information on all-transistor color bar generator.	Circle 117

SENCORE (Pg. 95) Information on CG 135 Transistorized color generator.	Circle 126
SONAR (Pg. 96) Information on Model FR101/102 Monitor Receiver.	Circle 128
SPRAGUE ELECTRIC COMPANY (Pg. 26) Electrolytic capacitor experiment Manual K-107.	Circle 15
SYLVANIA ELECTRIC CO. (Pg. 25) Information on color bright 85 color picture tube.	Circle 14
TEXAS CRYSTALS (Pg. 81) Catalog.	Circle 116
UNIVERSITY SOUND (Pg. 78) Hi Fi Guide and Guide to Commercial Sound Products.	Circle 111
WARREN ELECTRONIC COMPONENTS (Pg. 103) Information on Silicon Rectifiers.	Circle 136
WELLER ELECTRIC CORP. (Pg. 94) Literature on soldering guns.	Circle 125
WINDSOR (Pg. 96) Booklet: "The Open Door to TV Profits".	Circle 127
WINEGARD CO. (Pg. 84) Fact-finder #242 with information on Chroma-Tel antenna.	Circle 119
WUERTH PRODUCTS CORP. (Pg. 85) Information on the Surgistor.	Circle 121

RADIO-ELECTRONICS READER'S SERVICE

P.O. Box 7365, Philadelphia, Pa. 19101

The numbers I have circled below indicate the material I would like to receive:

1	2	3	4	5	6	7	8	9	10	11	12	13	14	15
16	17	18	19	20	21	22	23	24	25	26	27	28	29	30
31	32	33	34	35	36	37	38	39	40	41	42	43	44	45
46	47	48	49	50	51	52	53	54	55	56	57	58	59	60
61	62	63	64	65	66	67	68	69	70	71	72	73	74	75
76	77	78	79	80	81	82	83	84	85	86	87	88	89	90
91	92	93	94	95	96	97	98	99	100	101	102	103	104	105
106	107	108	109	110	111	112	113	114	115	116	117	118	119	120
121	122	123	124	125	126	127	128	129	130	131	132	133	134	135
136	137	138	139	140	141	142	143	144	145	146	147	148	149	150

VOID AFTER FEBRUARY 28, 1966

Name _____

Address _____

City _____ State _____

1-66 _____ Zip Code _____

Here's how you can get manufacturers' literature fast:

1. Tear out the post card on the facing page. Clearly print or type your name and address.
2. Circle the number on the card that corresponds to the number appearing at the bottom of the New Products, New Literature or Equipment Report listing in which you are interested. For literature on products advertised in this issue circle the number on the card that corresponds to the number appearing at the bottom of the advertisement in which you are interested, or use the convenient checking list in the column at the left.
3. Mail the card to us (no postage required in U. S. A.)

Note: If the postcard has already been detached from your copy of RADIO-ELECTRONICS, use the coupon on this page instead. Enclose the coupon in an envelope and address it to: RADIO-ELECTRONICS READER'S SERVICE, P. O. Box 7365, Philadelphia, Pa. 19101. (Use this address only for Reader's Service requests.)

NEW PRODUCTS

More information on new products is available free from the manufacturers of items identified by a Reader's Service number. Turn to the Reader's Service Card facing page 72 and circle the numbers of the new products on which you would like further information. Detach and mail the postage-paid card.



PICTURE-TUBE ANALYZER, the CRT-100, for color or black-and-white. Line-voltage adjustment; grid-cathode leakage measurement; heater-cathode leakage; quality-tests black-and-white CRT's (continuously variable and calibrated G2 voltage so that all tubes, present and future, can be tested); quality-tests color CRT's; removes shorts. High-energy rejuvenation; life test; plug-in cables, no unsoldering within instrument necessary; portable, in carrying case.—Lectrotech, Inc.

Circle 46 on reader's service card

COLOR BAR GENERATOR, model 900, has design feature which produces exceptionally square waveshapes. Instead of conventional oscillators for dividers, the 900 uses a ring-counter design with unijunction transistors serving as switches for counters. Has 10 color bars with posi-



tive graduation from color to color; bright and sharp single-trace horizontal lines that begin and end during horizontal trace; no blanking on crosshatch at any intensity level. Zener-regulated power supply, crystal-controlled oscillators. Channel tuner on front panel.—Seco Electronics Corp.

Circle 47 on reader's service card

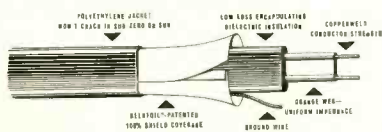

SHIELDED LEAD-IN, 8290 Shielded Permoht, features an orange-web-insulated 300-ohm pair encapsulat-

ed in low-loss cellular polyethylene insulation and Beldfoil, a patented 100% shield that stops transmission-line pickup of electrical noise, including automotive

ignition. Noncontaminating polyethylene jacket covers lead-in overall. Standoffs at antenna not required; 8290 can be taped to mast. 50-, 75-, 100-foot lengths with

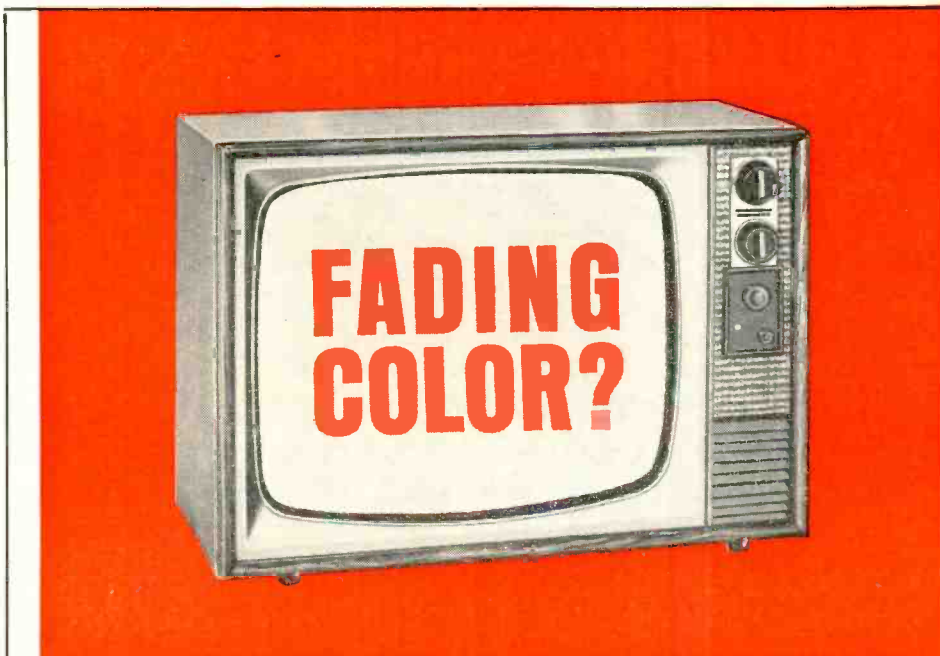

Perk it up with Perma-Power COLOR-BRITE

Perma-Power does for color TV sets what we've done for millions of black and white CRT's: adds an extra year of useful picture tube life.

When a color tube begins to fade, COLOR-BRITE *instantly* brings back the lost sharpness and detail. It provides increased filament voltage to boost the electron emission and return full contrast and color quality to the 3 gun color picture tube.

COLOR-BRITE is automatic... no switching or wiring. Just plug it in. Your delighted customers will brighten up as fast as their color sets!

Model C-501, for round color tubes.

List Price \$9.75

Model C-511, for rectangular color tubes.

List Price \$9.75



COLOR-BRITE is a Hue-Brite product from Perma-Power, famous in TV service for b & w Vu-Brites and Tu-Brites.

Perma-Power COMPANY

5740 N. TRIPP AVE., CHICAGO, ILLINOIS 60646
PHONE (312) 539-7171

Circle 106 on reader's service card

don't miss this exhibition
February 3 to February 8, 1966
at the Porte de Versailles in Paris

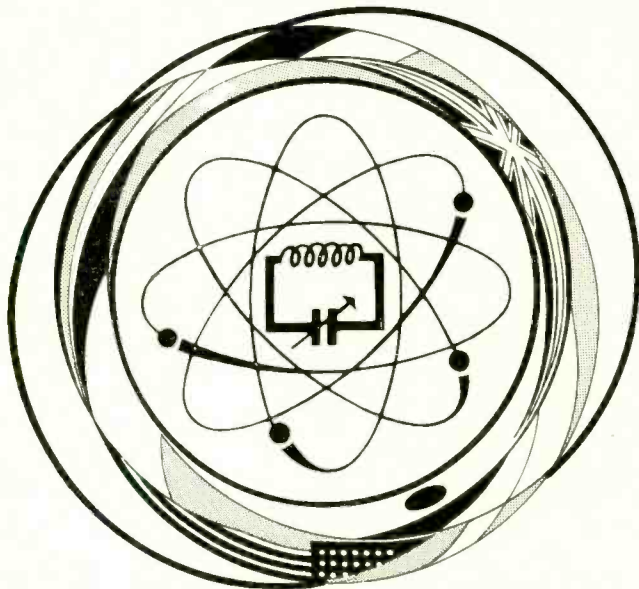

The first world-wide show of the year
the international exhibition of

ELECTRONIC COMPONENTS

and the International Exhibition of
AUDIO EQUIPMENT

featuring the most recent developments in electronic components, tubes and semiconductors, test equipment, control equipment, audio and hi-fi units

For information write directly to:

S.D.S.A., 16, Rue de Presles,
Paris, France. Tel. 273-24-70

Official Carrier:

Air France, Overseas Trade Show Department
683 Fifth Avenue, New York, N.Y. 10022

PUBLIC SERVICE
PARIS



To get your ticket of admission, fill in this coupon and mail it to S.D.S.A. Relations Extérieures, 16, Rue de Presles, Paris 15, France.

NAME

COMPANY

ADDRESS

INTERNATIONAL EXHIBITION OF ELECTRONIC COMPONENTS

factory-installed terminals; also bulk lengths.—Belden Mfg. Co., PO Box 5070A, Chicago, Ill. 60680

Circle 48 on reader's service card

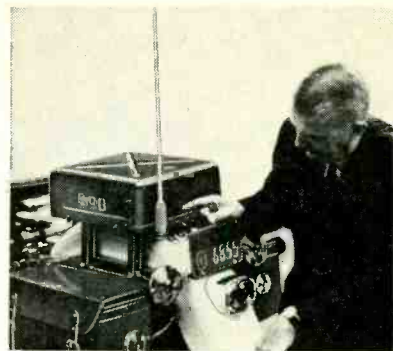

ANTENNA, Colorguard. Mobile communications antennas made with fluorescent "International Emergency Orange" material, designed for maximum visibility and easy identification of emergency radio-equipped vehicles on CB and business bands.—Antenna Specialists Co.

Circle 49 on reader's service card



COLOR TV TUNER CLEANER, Color Lube, built around chemical formula "TC-5", cleans and lubricates tuners in color sets without causing any frequency drift or detuning.—Chemtronics, Inc.

Circle 50 on reader's service card

LOW-CAPACITANCE LEVER SWITCHES, Series 10000 Lo-Cap, available in 2- and 3-position models, locking and nonlocking types, in variety of circuits from 2-A (dpst) to 8-C (8pdt). All models have flat actuator springs, round

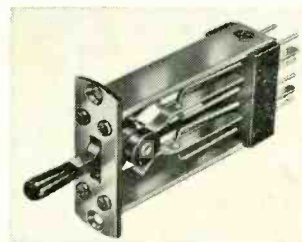

contact springs mounted in molded phenolic insulating block which eliminates induced alternating current between springs. Silver contacts are rated at 1 ampere, 100 watts max ac with noninductive load. Tinned terminals.—Switchcraft, Inc.

Circle 51 on reader's service card

LARYNX MIKE, AC-77, energized directly through vibrations of vocal cords, will not pick up sound waves from out-

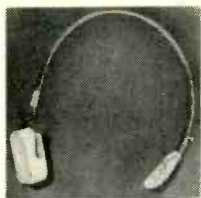

side. Available from 50 to 5,000 ohms. Frequency response 200 to 3,000 cycles. —Telephone Dynamics Corp.

Circle 52 on reader's service card

PROJECT CONSTRUCTION KIT, model PK-5. 5 Veroboards and instruction book for these projects: impedance-



matching module, engine pulse-counter module, audio amplifier and rf probe module, multivibrator module, audio oscillator module.—Vero Electronics

Circle 53 on reader's service card



STEREO CHANGER, model RC-2, the Balfour Princess, now available with audio cables, ac line cord, cartridge and diamond stylus. Tone arm has free lateral movement for uniform response on stereo channels, plus self-locking device against stylus damage.—Distributed by RFS Industries, Inc.

Circle 54 on reader's service card



PUSHBUTTON MULTITESTER, model TE-192, has 10 pushbuttons. 30,-

The only lab instrument you need to complete Scott's new 80-watt solid-state stereo amplifier kit

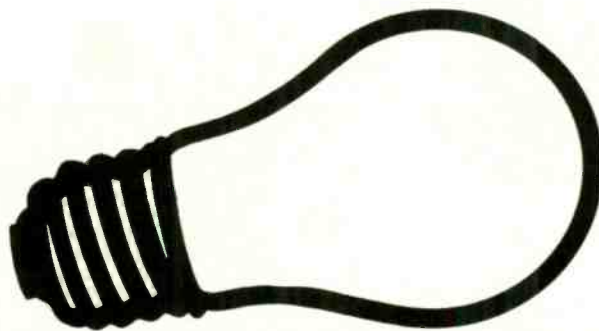

Scott's new solid state amplifier kit is completely protected against transistor blow-out. An ingenious "Fail-Safe" circuit using an ordinary light bulb takes the load off expensive silicon transistors when you first plug in your LK-60 . . . so, if you've made a wiring error (almost impossible with this kit), no harm done! Other bright new ideas from Scott: preassembled, factory-tested modular circuit boards; full-color instruction book; amazingly low price: \$189.95

Write for complete spec sheet: H. H. Scott, Inc., 111 Powdermill Road, Maynard, Mass. Export: Scott International, Maynard, Mass. Cable HIFI. Prices slightly higher west of Rockies.



Circle 108 on reader's service card

LOOK! A NEW ELECTRONICS SLIDE RULE

with complete instruction program

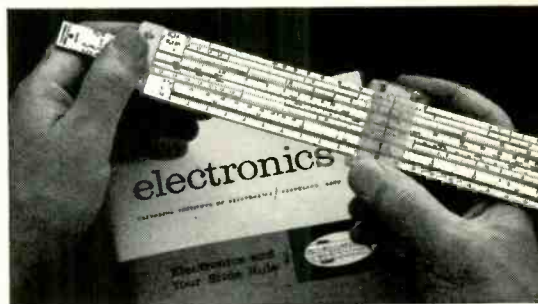

Here's a great new way to solve electronic problems accurately, easily . . . a useful tool for technicians, engineers, students, radio-TV servicemen and hobbyists. The Cleveland Institute Electronics Slide Rule is the only rule designed specifically for the exacting requirements of electronics computation. It comes complete with an illustrated Instruction Course. You get four AUTO-PROGRAMMED lessons . . . each with a short quiz you can send in for grading and consultation by CIE's expert instructors.

See for yourself. Learn how to whip through

all kinds of reactance, resonance, inductance, AC and DC circuitry problems in seconds . . . become a whiz at conventional computations too!

This all-metal 10" rule is made to our rigid specs by Pickett, Inc. . . . comes complete with top grain leather carrying case and Instruction Course. A \$50 value for less than \$20. Send coupon for FREE illustrated booklet and FREE heavy vinyl Pocket Electronics Data Guide. Cleveland Institute of Electronics, 1776 E. 17th St., Dept. RE-118, Cleveland, Ohio 44114.

GET BOTH FREE!



Send coupon today →

Cleveland Institute of Electronics

1776 E. 17th St., Dept. RE-118 Cleveland, Ohio 44114

Send FREE Electronics Slide Rule Booklet. Special Bonus: Mail promptly and get FREE Pocket Electronics Data Guide too!

NAME _____ (Please Print)

ADDRESS _____ COUNTY _____

CITY _____ STATE _____ ZIP _____

A leader in Electronics Training . . . since 1934

Circle 109 on reader's service card

Otto Werk sent in this Coupon

UNIVERSITY SOUND
Desk A-69, P.O. Box 1056 Oklahoma City, Okla. 73101

Please send me the New '66 University Hi Fi Guide.

Send me the New '66 Guide To Commercial Sound Products.

Name

Address

City State ZIP

Look what he got!

Lots of help . . . right from the horse's mouth. 'cause now University's got a Mustang! Plus a corral full of other speakers. University speaker guides showed him how to choose a speaker system, how to build a custom system with separate speakers—and much more! Send for these guides right away. You'll be an expert, too. Just like a smart Dane named Otto.



UNIVERSITY SOUND
A DIVISION OF LTV LING ALTEC, INC.

9500 W. Reno Oklahoma City, Oklahoma

Circle 111 on reader's service card

LATEST and GREATEST!

NEW *Brach* UHF/VHF TV ANTENNAS FOR Black/White & Color

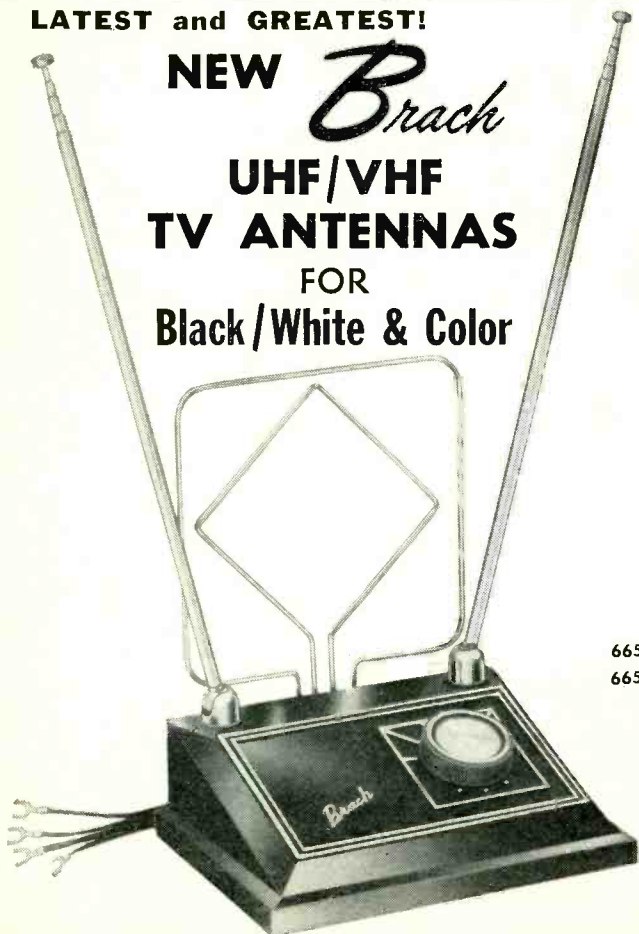

- Ultimate in Design!
- Unequaled in Performance!
- Outstanding in Value!

6651 Gold Finish
6652 Chrome Finish

SEND FOR our latest catalog with our complete line of antennas

BRACH MFG. CORP. DIV. of General Bronze Corp.

899 Main Street, Sayreville, N.J. 08872

Circle 112 on reader's service card

000-ohm-per-volt sensitivity. 1-volt dc full-scale range for measuring critical bias voltages in transistor circuits. "Off" switch damps meter movement for safety during transit. 1% precision resistors. Ranges: dc volts, 1, 10, 50, 250, 500, 1,000; ac 10, 50, 250, 500, 1,000. Current (dc) 50 μ a, 50 ma, 500 ma. Resistance 10 k, 100 k, 10 megohms. Capacitance 250 pf-0.2 μ f. Inductance 50-5,000 henry. -20 to +22 db, +22 to +36 db. Meter sensitivity 25 μ a. Uses 2 penlight batteries (included).
—Olson Electronics, Inc.

Circle 55 on reader's service card



SPLITTER/COMBINER, model SC80, a signal-divider network for distributing separate vhf, uhf and FM signals from single antenna system. All input and output connections matched to standard 300-ohm impedance of conventional antennas, transmission lines, TV or FM receivers. Insertion loss 0.5 db. Voltage standing-wave ratio 1.3 to 1. Frequency response in each band flat within $\pm 1/2$ db.
—JFD Electronics Corp.

Circle 56 on reader's service card

SKIN DIVERS' "UNDERCOM", called *Yack-Yack*, has two parts: face mask including mike and special sound diffuser to eliminate bubble sounds, and



compact noncorroding plastic case containing the amplifier circuitry, dry-cell battery and speaker. Complete system weighs 25 oz in water. Speech sounds heard 50 ft or more.—Raytheon Co.

Circle 57 on reader's service card

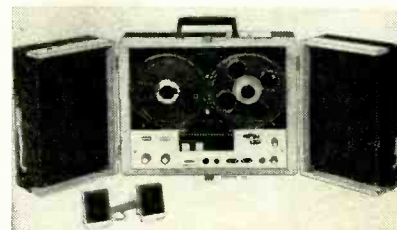

4-TRACK STEREO TAPE RECORDER, model RK-237. Speeds: 3 $\frac{3}{4}$ and 7 $\frac{1}{2}$ ips. Response: 40-15,000 cycles at 7 $\frac{1}{2}$. Wow/flutter 0.2%. Stereo separation: 45 db. Signal-to-noise ratio: 45 db. Inputs: mike, phono/radio. Outputs: hi-fi preamp, headphone. For 117 volts, 60 cy-

RADIO-ELECTRONICS

cles ac. 16½ x 11 x 7½ in. Two 4 x 6-in. detachable wing speakers, gray vinyl case.—Lafayette Radio Electronics Corp.

Circle 58 on reader's service card

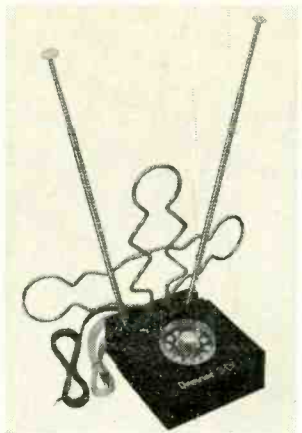

3 INDOOR TV ANTENNAS, 3D-2, 3-DX-2 (shown), S-3D-2, feature 2 lead-in cables for uhf and vhf reception, double set of phasing bars, one as uhf reflector and the other for vhf and color reception. 12-position dial switch.—Snyder Mfg. Co.

Circle 59 on reader's service card



MOISTURE-REPELLENT SPRAY, Cramolin Spray 3S, drives out condensation and seals dielectrically. Temperature range -50°C to +200°C, can be used continuously at 180°C, is able to stand temperature of an arc for up to 80 seconds.—Caig Laboratories

Circle 60 on reader's service card

HAND TOOL, the *Triceps*. Depress the plunger and 3 resilient, hooked fingers flare out from tip, retract and grasp

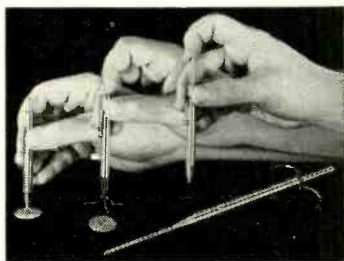

an object by positioning the fingers and releasing plunger. Stainless steel, 6 models ranging in length from 4½ to 18 in.—Universal Technical Products Co.

Circle 61 on reader's service card

PORTABLE RADIO KIT, model GR-43, all-transistor, 10 bands. Tunes 150-400 kc long-wave, 88-108 mc FM,



550-1,600 kc AM, plus 7 short-wave bands covering 2-22.5 mc. 16 transistors, 6 diodes, 44 factory-assembled rf circuits. Two built-in antennas, battery-saver switch. 4 x 6-in. speaker. Runs on 6 "D" flashlight batteries and 1 "C" battery for dial light. Also operates on 117 vac with optional converter/charger.—Heath Co.

Circle 62 on reader's service card

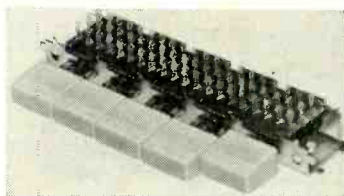

MINIATURE PUSHBUTTON SWITCH, type MX, available for printed-circuit and/or hand wiring. Maximum 15 watts dc, 25 ac; 1 to 12 buttons, each button supplied with maximum of 8 poles, double-throw. Overall thickness under ¼

Why Do You Read So Slowly?

A noted publisher in Chicago reports there is a simple technique of rapid reading which should enable you to double your reading speed and yet retain much more. Most people do not realize how much they could increase their pleasure, success and income by reading faster and more accurately.

According to this publisher, anyone, regardless of his present reading skill, can use this simple technique to improve his reading ability to a remarkable degree. Whether reading stories, books, technical matter, it becomes possible to read sentences at a glance and entire pages in seconds with this method.

To acquaint the readers of this publication with the easy-to-follow rules for developing rapid reading skill, the company has printed full details of its interesting self-training method in a new book, "Adventures in Reading Improvement" mailed free to anyone who requests it. No obligation. Simply send your request to: Reading, 835 Diversey Parkway, Dept. 4481, Chicago, Ill. 60614. A postcard will do. Include your zip code.

Circle 113 on reader's service card

ATTENTION! CB OPERATORS

save on citizens radio equipment

Discontinued Models From International Radio Exchange

Select that extra transceiver for mobile or base installation, or equip a new station. Our stock includes International types as well as other makes.

Write Today for A Complete List of Equipment in Stock



RADIO EXCHANGE
18 NO. LEE, OKLA. CITY, OKLA. 73102
Division Of International Crystal Mfg. Co.
Dealing In Used Citizens Radio Equipment



Circle 114 on reader's service card

in.; used on printed-circuit board, height above board is less than 15/32 in.—Seacor, Inc., 598 Broadway, Norwood, N.J.

Circle 63 on reader's service card



FM/STEREO TUNER-AMPLIFIER, the RA-727. FM multiplex tuner has

input sensitivity of 1 μ v, multiplex channel separation of 30 db. Amplifier power output: 44 watts. Frequency response 30 to 30,000 cycles. 9 1/2 x 12 1/2 x 5 1/4 in.—Olson Electronics

Circle 64 on reader's service card

FM-STEREO MULTIPLEX SIGNAL GENERATOR, model FMX-103. Internal audio oscillator: 500, 2,000, 5,000 cycles \pm 1 db, 67 kc SCA, 1 volt rms. FM rf output: 107 mc (\pm 2 mc adj) carrier, deviated 75 kc. FM SCA per FCC (rear switch for 60-cycle sweep). Composite MPX output: 0 to 3 volts peak-to-peak composite FM stereo. Pilot carrier: 19 kc \pm 2 cycles stability, 0 to 10% amplitude control at rear, special -45° se-

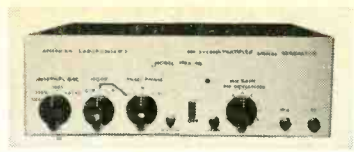

lection for left- and right-channel identity and for checking receiver subchannel quadrature null. 1% audio distortion. 35-db left and right stereo separation. Down 50 db residual hum (zero on battery). 1% or less 38-kc carrier residual. Main to stereo subchannel crosstalk: 40 db or more. Printed-circuit chassis, 8 transistors, 9 diodes. 3 1/2 x 10 1/2 x 7 1/2 in.—American Laboratories

Circle 65 on reader's service card

FREE

NEW 1966 GIANT CATALOG

1966 ANNUAL CATALOG NO. 661
RADIO-TV-ELECTRONICS
INDEX PAGE 226...PHONE BALHmore 1-1156

BURSTEIN-APPLEBEE CO.
1000 Burt St., 2nd Fl. Kansas City, Mo. 64106
1237 14th St. Denver, Colo.

TUBES PARTS ETC. AT LOWEST PRICES

SAVE UP TO 50% ON CHOICE KITS

Satisfaction GUARANTEED or your money back!

SAVE ON CAMERAS FILM & PHOTO EQUIPMENT

NO MONEY DOWN PLUS REVOLVING CHARGE ACCOUNT

100's of pages packed with savings

100'S OF BARGAINS NOT IN ANY OTHER CATALOG

100's of new items listed for first time

EVERYTHING IN HI-FI AND STEREO

TOP VALUES IN POWER & HAND TOOLS

FOR 38 YEARS THE OUTSTANDING MONEY SAVING BUYING GUIDE FOR:

- Stereo & Hi-Fi Systems and Components
- Tape Recorders
- Electronic Parts, Tubes, Books
- Phonos & Records
- Ham Gear
- Test Instruments and Kits
- Cameras and Film
- Public Address
- Citizens Band
- Transistor & FM-AM Radios.

RUSH COUPON TODAY

BURSTEIN-APPLEBEE CO. Dept. RE, 1012-14 McGee St., Kansas City, Mo. 64106

Rush me the FREE 1966 B-A Catalog.

NAME _____

ADDRESS _____

CITY _____ STATE _____

Please be sure to show your Zip No. _____

Circle 115 on reader's service card



PRINTED-CIRCUIT SPRAY, Poly Spray, a polyurethane composition, forms transparent coating to resist moisture and abrasion, prevents intermittent defects by damping the vibration of parts of printed circuit. To be used after printed-circuit repair.—Injectorall Electronics Corp.

Circle 66 on reader's service card

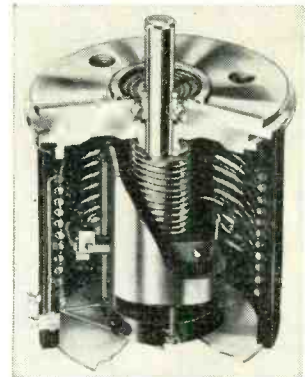

POTENTIOMETERS with improved linearity announced by Amphenol. The 10-turn 900 series now has \pm 0.1% absolute linearity; the 3-turn 930 \pm 0.25%. No additional cost.—Amphenol Controls Div. END

Circle 67 on reader's service card

WHY GLOW LAMPS GLOW

Ionic glow lamps (like neon lamps) are used in computers, electronic organs, color television sets, tape recorders, test instruments, regulated power supplies, and hundreds of other kinds of electronic apparatus. How do they work? Read all about them, and try practical circuits: an electronic siren or chime, computer logic flip-flops, relay triggers.

Coming in February RADIO-ELECTRONICS

NEW LITERATURE

All booklets, catalogs, charts, data sheets and other literature listed here are free for the asking (except where a price is given). Each item is identified by a Reader's Service number. Turn to the Reader's Service Card facing page 72 and circle the number of items you want. Then detach and mail the card. No postage required!

SIMPLIFIED TOOL CATALOG, SD-76. Over 300 items in screwdrivers, nutdrivers, pliers, wrenches, specialty tools. Illustrated.—Vaco Products Co.

Circle 68 on reader's service card

ANTENNA ROTOR SYSTEMS, Bulletin 252-8P. 8 pages, looseleaf punched, description and photos of CDE series rotor (rotator) and controls, TEN series rotor and controls.—Cornell-Dubilier Electronics.

Circle 69 on reader's service card

BOOKLET, No. 50, How to Plan a Home TV System. Pocket-size, 12 pages, with charts for selecting the best TV antenna system for your area.—Blonder-Tongue Labs, Inc.

Circle 70 on reader's service card

COLOR TV REPLACEMENT GUIDE, Stancon 5-1064C, 6-page foldout gives replacement numbers for flybacks, yokes, vertical outputs, power transformers on 28 makes of color TV.—Electronic Marketing Div. of Essex Wire Corp.

Circle 71 on reader's service card

GLASS CAPACITORS CATALOG B-9157, 4 pages, specs, charts, dimensions of military type CY and industrial type CYW capacitors.—Westinghouse Electronic Capacitor Dept.

Circle 72 on reader's service card

TOOL CATALOG, No. 65. 8 pages, universal-punched, photos, dimensions, prices of inspection mirrors, magnetic retrieving tool (all-angle and flexible), mechanical fingers, screw starters. Ulman Devices Corp.

Circle 73 on reader's service card

SPEAKER/MICROPHONE STAND CATALOG, No. 565. 10 pages, looseleaf-punched, with photos and specs of complete line of speakers, trumpets, driver units, transformers, mike stands, accessories.—Atlas Sound

Circle 74 on reader's service card

'66 TV POCKET PROMPTER, 3 x 6½ in., spiral-bound, 96 pages, illustrates complete line of black-and-white and color TV, solid-state stereo. Has foldout feature guides on each category.—Westinghouse Appliance Sales & Service

Circle 75 on reader's service card

BUSINESS/INDUSTRIAL COMMUNICATIONS BROCHURE, 6 pages, describes features and applications of line of Messenger 2-way radio equipment, from 1½-watt hand-held units to high-power units. FCC type-accepted.—E. F. Johnson Co.

Circle 76 on reader's service card

WIRE GUIDE, a wall chart which features theoretical values of standard annealed copper wire AWG (B & S), and copper wire stranded construction.—Birnbach Radio Co., Inc.

Circle 77 on reader's service card

REVISED TEFLON ENGINEERING MANUAL, Bulletin 206, Rev. A, 12 pages, well illustrated, gives history of Teflon, applications such as wire harness, tube support, insulating clamps with detailed engineering prints, characteristics chart of Teflon.—TA Mfg. Corp. END

Circle 78 on reader's service card

Whether on land, sea or air, your radio communications will be more dependable with TEXAS CRYSTALS... made with the same precision, care and quality as those supplied to numerous space projects. And, you'll appreciate the attractive prices. Send for descriptive catalog today.

If your dealer can't supply your TEXAS CRYSTALS needs, send his name with your order to our plant nearest you.

TEXAS CRYSTALS
A Division of Whitehall Electronics Corp.

1000 Crystal Drive Fort Myers, Florida Phone 813 WE 6-2109
4117 W. Jefferson Blvd. Los Angeles, California Phone 213 731-2258

Circle 116 on reader's service card

new!

All-Transistor Color Bar Generator

Rugged, solid-state Seco 900 puts you on top of the booming Color-TV Service Market... with the finest unit in the field!

Setting new standards in both engineering and design, Seco's new Model 900 will outperform every other color bar generator on the market! A true precision instrument that offers brightest dots and purest color quality, the 900 takes the "guess" out of color TV-servicing, makes possible big new profits in the booming color service field!

Only the Seco 900 offers all of these features:

- Single Burst Dots are bright—"rock" solid... will not move
- Purest Color Quality—10 completely different color bars... positive graduation from color to color
- Single Trace Horizontal Lines—are bright, sharp... begin and end during horizontal retrace
- No Blinking On Cross Hatch—at any intensity level
- All Transistor Circuit—for highest reliability and instant operation with no warm-up
- Outstanding Stability—Zener regulated power supply... crystal controlled oscillators!



SECO ELECTRONICS CORP., 1209-B So. Clover Dr., Minneapolis, Minn. 55420

\$12995

Dealer Net



Circle 117 on reader's service card

THE PHANTOM RESISTOR

A tale of spring love and a shorted transistor on a winter's day

By WAYNE LEMONS

THE WINTER WINDS WERE WHISTLING. Cy, owner of Town & Country TV, had his coat collar turned up and almost missed the bizarre scene in front of the shop. He hadn't realized before just how odd it must look to passersby to see two size 10 shoes attached to spindly legs sticking up toward the ceiling of a car. He recognized the shoes as belonging to his young helper Lucky. He knew the customer must have been very persuasive or very pretty to induce Lucky to pull a car radio on a morning like this.

Cy opened the car door and peeked in.

"Shut that darn door," growled Lucky "I'm having enough trouble with this radio without freezing to death too!"

Cy ignored the outburst. "Just what's the trouble?"

"No trouble," said Lucky disgustingly, "I like pulling car radios on cold mornings. It's good for my circulation."

Cy grinned, "It must be, to look at your face. All that blood up there should fertilize your brain and maybe we can make a technician out of you yet. Just what is the matter? No output or what?"

"That's right," said Lucky, "no output."

"Did you check the speaker?"

"Nope, couldn't get to it."

"Was there a thump in the speaker when you turned the radio on?"

"I don't remember. Should there be?"

"Sure there should be. This is a hybrid radio with transistor output. Always check for a thump when you turn the radio on."

"What does a thump mean?"

"Well, if you hear it, it means the speaker is probably OK, and most likely the transistor output stage too."

"You mean you won't hear a thump if the transistor isn't working?"

"Usually not."

"What if the transistor were shorted? Wouldn't there be a thump in the speaker anyhow?"

"That's a good question," said Cy.

"But you forget that, if the transistor is shorted, the chances are the fuse resistor in the emitter is open and so there won't be much thump."

"OK, so I'll turn it on and see what happens."

He turned it on. There was no noticeable noise in the speaker.

"Tubes lit?" asked Cy.

"Yep," said Lucky. "So I know the fuse is good. Should I go ahead and pull the radio now, sir?"

"Not without making another test."

"What's that?"

"The speaker."

"But I told you I couldn't reach it till I get the radio out."

"Well, I'm not so sure about that, but you can reach the heat sink, can't you?"

"Sure."

"So, OK. Wait a minute and I'll get an ohmmeter."

Cy returned with the ohmmeter and handed the leads to Lucky. "Use the $R \times 1$ scale and touch between the heat sink and ground."

"Why that?"

"Well, in this model the heat sink is insulated from the chassis and the transistor collector is tied to it."

There was a scratching sound as Lucky moved the probes about between the heat sink and the chassis.

"What's all this prove?" Lucky wanted to know.

"Well," said Cy, "for one thing it proves that the speaker isn't open and that it's connected to the radio. And it proves that the output transformer isn't open or shorted and . . ."

"It also proves," Lucky broke in, "that the heat sink isn't grounded to the chassis."

"Now you're getting the idea," praised Cy. "The more we find out about the radio before we pull it the better off we'll be."

"Is there anything else to do before I pull a radio?"

"Depends a lot on the trouble," said Cy. "There are several other things

that could be done, depending on circumstances."

"What, for instance?"

"Turn the volume full up and listen carefully in the speaker for signs of life . . . a slight pop or crack or a sustained hiss."

"What's that mean?"

"It means you may be able to tell if you really have radio trouble."

"Just what do you mean by that? We know we've got radio trouble!"

"Yep, in this case we do since there wasn't any thump in the speaker and we now know that the speaker is probably OK, but what if we had heard the thump?"

"We'd know the trouble probably wasn't in the output stage."

"Right," Cy agreed. "But you wouldn't know if the trouble was in the radio or if it might be in the antenna."

"I see what you mean. You mean if we had heard a thump the trouble could be any place before the output stage, including the antenna."

"That's what I said, and that's the reason for turning the volume up full and listening for 'signs of life'."

"But what if we do hear 'signs of life'?"

"Then before we pull the radio we plug in our test antenna and try again."

"So, if there's no music then?"

"Then we probably have either rf or oscillator trouble and, if we can't get the tubes out, we pull the radio."

"Fine," said Lucky. "That's what I've been trying to do for the last hour."

"Nobody's holding you, hop to it," laughed Cy. "But now you can be reasonably sure you're not going to be embarrassed by having to tell that pretty girl in there that you made a mistake and that the radio wouldn't have to be pulled after all."

"Say," said Lucky, "she is kinda pretty at that."

"I figured you noticed," Cy smiled knowingly.

"What do you think is wrong with her radio here?"

"Oh ho," laughed Cy, "so you want to impress the pretty girl with a fast diagnosis and repair. Well, I have nothing against young love. I'll help you if I can, but an unproved diagnosis is just a hunch."

"So what does your hunch say?"

"A defective transistor, I would guess."

"Wouldn't that burn out a fuse?"

"Not very likely, but if it shorted it will probably have blown the emitter fusible resistor."

Ten minutes later Lucky had the set on the bench. He pulled the output transistor and put it in the checker. It was shorted. "That's it," he said half to himself. He installed a new one hurriedly. He hoped the pretty girl was watching. She'd be impressed with his efficiency. He soldered in the emitter and base connections, tightened up the collector nut, made a check with the ohmmeter and turned on the radio.

He waited a minute, then two, but there was only very weak output on a strong local station. He made a check with the voltmeter and looked dumfounded; the pretty girl was watching intently now. Cy also noticed the exasperation on Lucky's face and felt a little sorry for him. After all, she was a very pretty girl.

"Still got troubles?" he asked quietly.

"I'm afraid so," admitted Lucky.

"The transistor shorted?"

"Yow."

"You replace the emitter resistor?"

"Nope, it checked OK."

"I was afraid of that."

"Afraid of what?"

"I'll bet you got a false reading. What did the ohmmeter say?"

"I don't know exactly," confessed Lucky, "but somewhere around 20 or 30 ohms. The schematic says the resistor is 33 ohms so I figured it was OK."

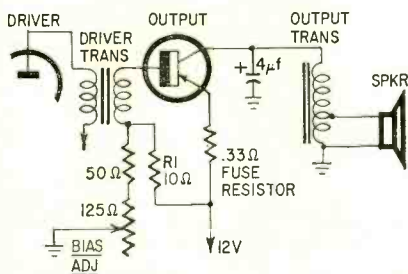

Schematic of the output stage of the car radio Lucky got snagged on. Simple circuit hides a number of troubleshooting pitfalls.

"That's fine, except you figured wrong. You either overlooked a decimal point or the schematic has a misprint."

They looked at schematic together.

"See? 33 ohms," said Lucky.

"Let's look at the parts list," advised Cy. "That value can't be right."

The parts list showed 0.33 ohm.

"Just what I thought. That resistor is always less than 1 ohm. I think your troubles will be over when you replace the emitter resistor. And be sure to replace it with the same type. We have them in stock."

"But how did I get a reading across it? Did it change value to 20 or 30 ohms?"

"I doubt it," Cy said. "Look at the schematic. You were the victim of a common occurrence in transistor circuit testing. You measured across the resistor, and even with it open you still got a reading through the 10-ohm bias resistor R1, through the secondary of the input transformer and through the transistor itself which gave you the 20 or 30 ohms."

"If the ohmmeter probes had been reversed, I wouldn't have got a reading through the transistor, would I?"

"No, not so much, and you would have noticed the difference if you'd reversed the probes after the first reading. However, if you'd known the resistor was a small one, you'd have also known that 20 or 30 ohms was wrong."

"But one other thing I did."

"What's that?"

"I checked the voltage on the emitter and it was just what it was supposed to be. How could it have 12 volts on it with the emitter resistor open?"

"Just like the ohmmeter can read through the transistor. The voltage from the base appears on the emitter when the emitter is open. You should have read between emitter and base. Then you'd have noticed that the transistor was zero-biased—cut off."

"Well, I'll be darned," Lucky muttered.

Neither had noticed till now that the pretty girl was looking over their shoulders.

"Oh, I think you people in electronics are so clever. It's just like detective work, isn't it?"

Lucky reddened but Cy smiled and answered for them both, "A little bit, I guess," he said.

Fifteen or twenty minutes later Cy looked out the front window. Lucky and the girl were in deep conversation. "It must be pretty cold out there," thought Cy. The two young people didn't seem to notice, though. "The first signs of spring," Cy thought happily and turned to his work with a smile. END

Now save hours of design time
with GERNSBACK LIBRARY'S new

ELECTRONIC DESIGN CHARTS

By Norman H. Crowhurst

A comprehensive collection of nomographs in one convenient book.

Simplifies design procedures. Saves hours of time and effort on computations. Helps solve virtually every electronic design problem quickly. Eliminates uncertainty and mistakes. Large, accurate, clear charts on 8½ x 11 page size. Lies flat or stands up.

- 59 CHARTS
- 128 PAGES
- FULL EXPLANATION
- EASY-TO-READ TEXT

An invaluable, convenient working tool for engineers and technicians with useful charts like these: Frequency and Wavelength • Reactance and Frequency • Time Constants • Input Chokes • Vector Addition of Complex Quantities • Parallel Resistors and Series Capacitors • AND 53 OTHER CHARTS.

BOOKS PURCHASED FOR PROFESSIONAL PURPOSES ARE TAX DEDUCTIBLE

Permanently cloth-bound \$5.95

Money-back guarantee within 10 days if not completely satisfied with book

GERNSBACK LIBRARY, Inc., Dept. 166
154 West 14th Street, New York, N. Y. 10011

Enclosed is \$_____. Please send _____ copy(ies) of **Electronic Design Charts** @ \$5.95.

Name _____

Street _____

City _____ State _____ Zip Code _____

Because you've got to SEE it to BELIEVE it... we will send you a FREE sample!



A REVOLUTIONARY NEW METHOD FOR MARKING ELECTRONIC EQUIPMENT

Try this sample and you'll agree "Instant Lettering" is the easiest, quickest way to get professional lettering you've ever seen. Self-adhesive letters printed on a special plastic sheet are just pressed down into position on any equipment, drawing, schematic, etc. Transfers to practically any surface. Looks like printing.

- AVAILABLE IN THE FOLLOWING SETS AT \$4.95 EACH
- TITLES FOR ELECTRONIC EQUIPMENT
 - TERMINAL & CHASSIS MARKING KIT
 - METER & DIAL MARKING KIT

With these three kits you can completely mark prototype electronic equipment from component parts to finished control panel and meters—and make them look like finished production equipment. In stock at leading electronics distributors or direct.

SEND FOR FREE SAMPLE AND FOLDER
THE DATA CORPORATION
 63 71st STREET • DEPT. 649 • GUTTENBERG, N. J.
 Circle 118 on reader's service card

Meet Winegard Chroma-Tel

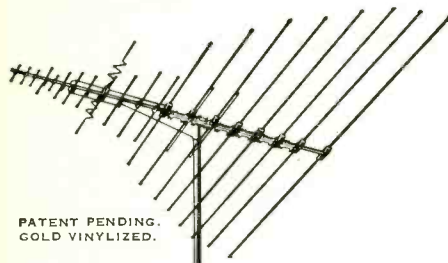

PATENT PENDING.
 GOLD VINYLIZED.

First 1/2 size all-band (UHF, VHF, FM) antenna with full size power

- Delivers Brilliant Color, Beautiful Black and White, Full-Tone FM Sound
- Brings in All the UHF, VHF and FM Stations in Your Area

Now there's an All-Band (UHF, VHF, FM) antenna that is actually half the size of most other all-band antennas. It eliminates half the bulk, half the wind loading, half the storage space, half the truck space and half the weight of ordinary all-band antennas... without sacrificing one bit of performance! Features Winegard's new Chroma-Lens Director System and impedance correlators.

Compare size, cost and performance... you'll choose Winegard Chroma-Tel every time. Ask your distributor or write for Fact-Finder #242 today.

3 Models from \$17.50 list.

Winegard Co. ANTENNA SYSTEMS
 3000 Kirkwood • Burlington, Iowa

Circle 119 on reader's service card

NEW SEMI-CONDUCTORS AND TUBES

NEW TUBES FOR COLOR

The sudden growth of color TV during 1965 spawned schools of new receiving tubes designed especially for the stiffer high-voltage and deflection-power requirements of color, and for the special circuits like chroma demodulators, bandpass amplifiers, and such-like.

Most prolific of the new-tube producers was Sylvania, which racked up a score of 13, not including the heater-

rating variations of a single basic type.

New are the **2AV2**, a focus rectifier with a 9-pin miniature base; **3BF2**, high-voltage rectifier with 12-pin base and peak-inverse-voltage rating of 35 kv; **6AC9** (8AC9), pentode with double diode on 12-pin base, for use as i.f. amplifier and phase detector; **6CE3** (34CE3), 12-pin dampers with 11 watts dissipation; **6CH3**, same as the 6CE3 except for a large 9-pin base; **6JS6A** (31JS6A), 12-pin horizontal deflection amplifiers with 28 watts plate dissipation; **6KN6** (42KN6), twin beam pentode with sections internally connected in parallel, for high-power horizontal deflection (30 watts total tube dissipation); **6LR8** (21LR8), vertical deflection oscillator and amplifier with 9-pin (large) base, high-mu triode oscillator and low-B-plus beam pentode amplifier; **6LU8** (21LU8), same as 'LR8 except for 12-pin base; **9KC6**, frame-grid pentode with 9-pin miniature base and dual-

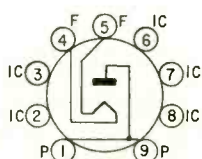

2AV2

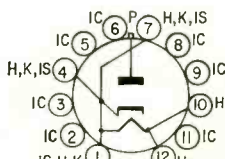

3BF2

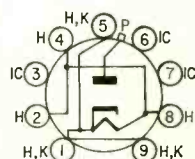

3BH2

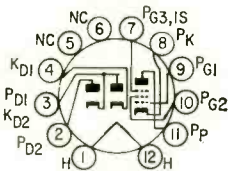

6-8AC9

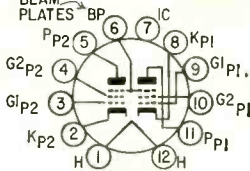

6AF10

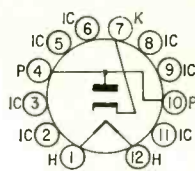

6-34CE3

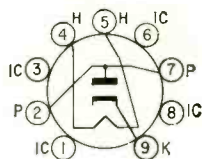

6CH3

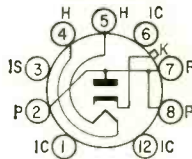

6EC4

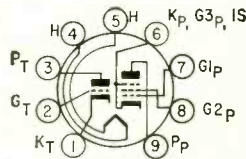

6-8-10J78

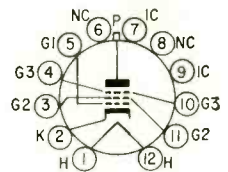

6-31JS6-A

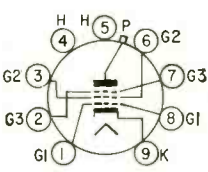

6KG6

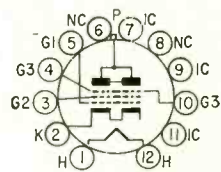

6-42KN6

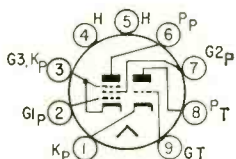

6-21LR8

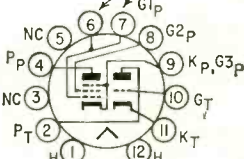

6-21LU8

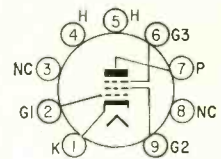

9KC6

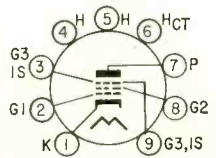

12GN7-A

Radio-Electronics Is Your Magazine!

Tell us what you want to see in it. Your suggestions may make it a better magazine for the rest of the readers as well as yourself. Write to the Editor, RADIO-ELECTRONICS, 154 West 14th St., New York, N. Y. 10011.

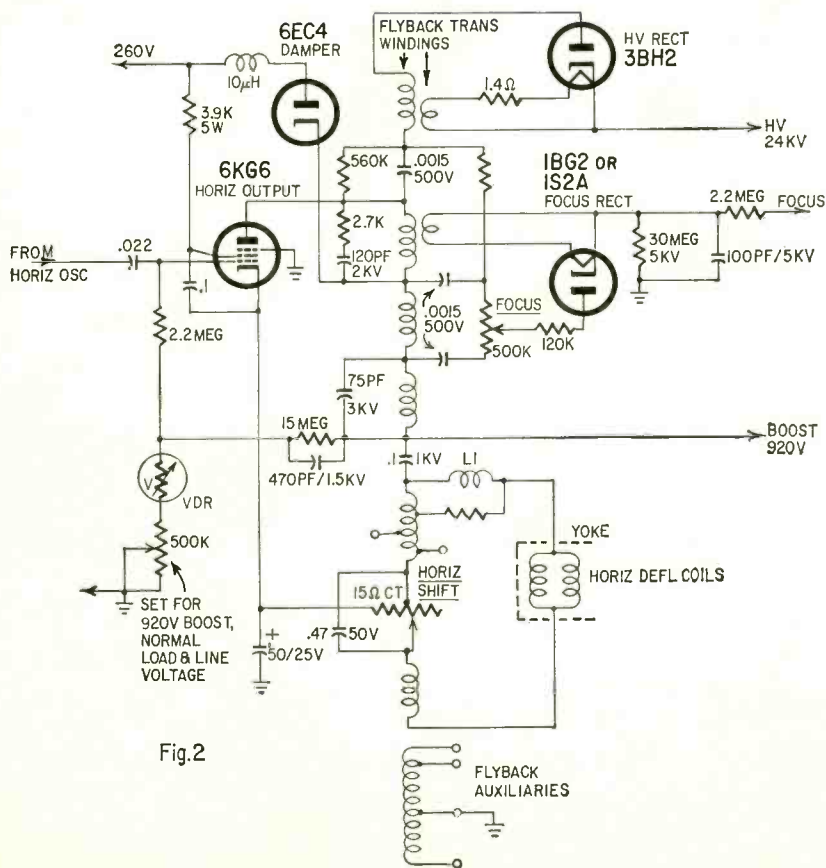
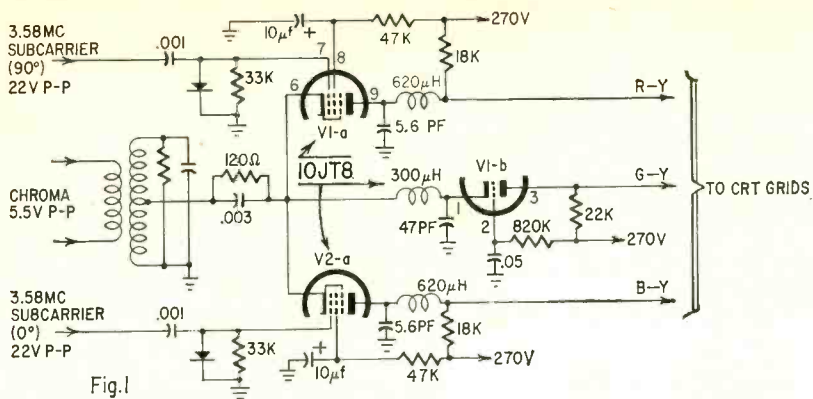

INNOVATION INNOVATION INNOVATION INNOVATION



In Electrical Electronics Engineering

EXHIBITS (4 days only)

Monday - Thursday
11:30 A.M. - 9:30 P.M.

NEW YORK COLISEUM

TECHNICAL SESSIONS

Monday - Friday
NEW YORK HILTON
MARCH 21-25

Members \$2. Non-Members \$5.



IEEE EXHIBITION

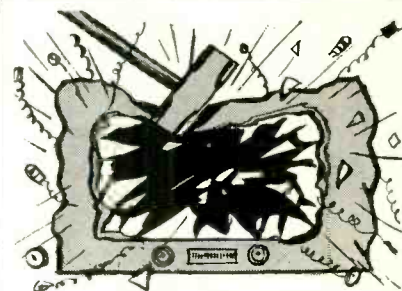

STOP!

WRECKING YOUR TV . . .

Inrush surge currents at 'Turn-On' destroy more TUBES, RECTIFIERS, and CAPACITORS than all other causes . . . EFFECTIVE, AUTOMATIC REDUCTION of the punishing inrush currents is immediately provided by the . . .

WUERTH SURGISTOR®



117 V.
AC-DC

Watts Range	Wuerth No.	Workman No.	G-C No.	List Price
100-275	4100-2	SR-1	25-894R	1.95
250-400	8050-4	SR-2	25-896R	2.95
300-500	8035-5	SR-3	3.30
450-650	1025-6	4.95
600-850	1020-7	5.45
800-1200	1015-8	5.95
1170-1500	1010-9	6.95

Use SURGISTORS with your TV, Hi-Fi, Film Projector, or any other device requiring inrush surge current protection. SEE your distributor or dealer TODAY. Or, send order direct to us for prompt action.

WUERTH PRODUCTS CORP.
1931 Pembroke Road Hollywood, Florida

Circle 121 on reader's service card

control-grid arrangement, for use as chroma bandpass amplifier, color demodulator or video amplifier; **12GN7A**, very-high-transconductance video amplifier pentode ($G_m = 36,000$) with 9-pin miniature base; and the **6AF10**, a double-dissimilar pentode with 12-pin base, of which the first pentode, with ordinary grid construction, can be used as sound i.f. amplifier, while the other, with a strap frame grid, is intended as a video amplifier.

Sylvania has developed an interesting circuit around one of the new tubes

—the **6JT8** (or 8- or 10-). It's shown in Fig. 1. Two 'JT8's are used, leaving one triode section free to work as a color killer or sync separator. Chroma (color) information is applied to the cathodes of both pentode sections (V1-a, V2-a) from a low-impedance source, while the 3.58-mc subcarrier voltage is applied, with the correct phase relationship, to the two No. 1 grids. The demodulated R - Y and B - Y signals are developed across the 18,000-ohm plate resistors, and drive the red and blue guns directly.

The G - Y signal is developed

across the 120-ohm resistor in the common cathode circuit, and applied through a low-pass filter to the cathode of the triode amplifier, V1-b. The filter blocks the chroma and subcarrier voltages, and prevents the triode (a grounded-grid stage with a low input impedance) from loading the chroma source. The grounded-grid circuit amplifies the G - Y signal in the proper phase to drive the green gun of the picture tube.

Amperex Electronic Corp. has introduced a family of three tubes for use in the horizontal deflection circuitry of color sets. It includes the **3BH2** high-voltage rectifier, with a peak-inverse rating of 35 kv; the **6EC4**, a damper

First One-Piece All-Channel Antenna with Individual UHF and VHF Orientation

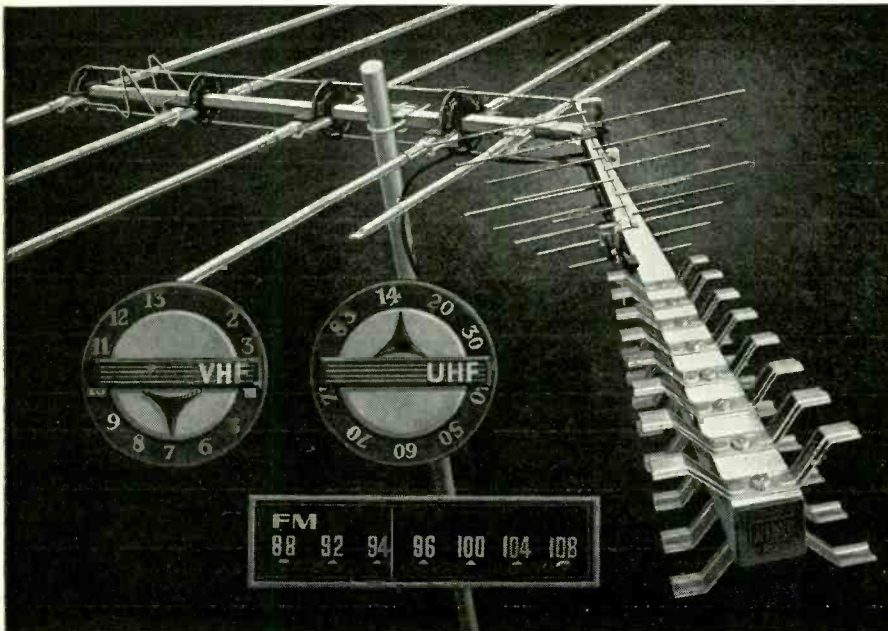

New JERROLD Coloraxial™ *Pathfinder*™

Take advantage of the growing UHF and FM stereo markets by selling *the* antenna to answer every home reception need from metropolitan to deep-fringe areas... Jerrold's new Coloraxial PATHFINDER.

Look at the advanced design of the PATHFINDER (Series PAB and PXB): a cascaded periodic VHF section plus a radically new UHF section hinged for individual orientation and maximum directivity. Here's all the flexibility of separate antennas, without the splitter losses from coupling separate antennas to a common download.

Both 75-ohm Coloraxial and 300-ohm standard outputs for every taste and budget. Prices as low as \$21.95. Rugged square-boom construction and Golden Armor corrosion-resistant finish assure long life. Flat response across all 82 channels, low VSWR, excellent front-to-back ratio make PATHFINDER a natural for quick sales and satisfied customers. Send coupon for complete information.

JERROLD

JERROLD ELECTRONICS CORPORATION
Distributor Sales Division, Dept. RE-1
1514 & Lehigh Ave., Philadelphia, Pa. 19132
Please send me complete information on
PATHFINDER all-channel TV and FM antennas.

Name _____
Company _____
Address _____
City _____ State _____ Zip _____

Circle 122 on reader's service card



diode with an 11-watt plate dissipation rating, and the **6KG6**, a beam pentode with a large 9-pin base and a 34-watt dissipation rating. Their base diagrams are shown with the others.

Amperex has designed a comparatively simple horizontal deflection and high-voltage circuit around its three new tubes (Fig. 2). It is designed around a 1.5- to 3-mh yoke requiring about 3 amps peak-to-peak deflection current. B-plus need be only 260 volts nominal, with a current draw of 220 to 310 ma for zero to 850- μ a beam-current variation. Nominal high voltage is 24 kv. The horizontal deflection oscillator (not shown) is the pentode half of a 6BL8, connected in a Colpitts-like circuit. The focus rectifier could be omitted by deriving the focus voltage from a high-resistance divider across the high-voltage supply. If component tolerances are small enough, even the horizontal centering circuit could be omitted.

Note the absence of a high-voltage regulator tube (a 6BK4-A in RCA sets, for example). The voltage to the CRT ultor is held stiff by a feedback circuit that includes a voltage-dependent resistor (VDR) in the grid circuit of the horizontal output stage. This is considerably simpler than the tube regulator circuit used in most sets. High-voltage swings between 24 and 21.5 kv as beam current rises from zero to 850 μ a. END

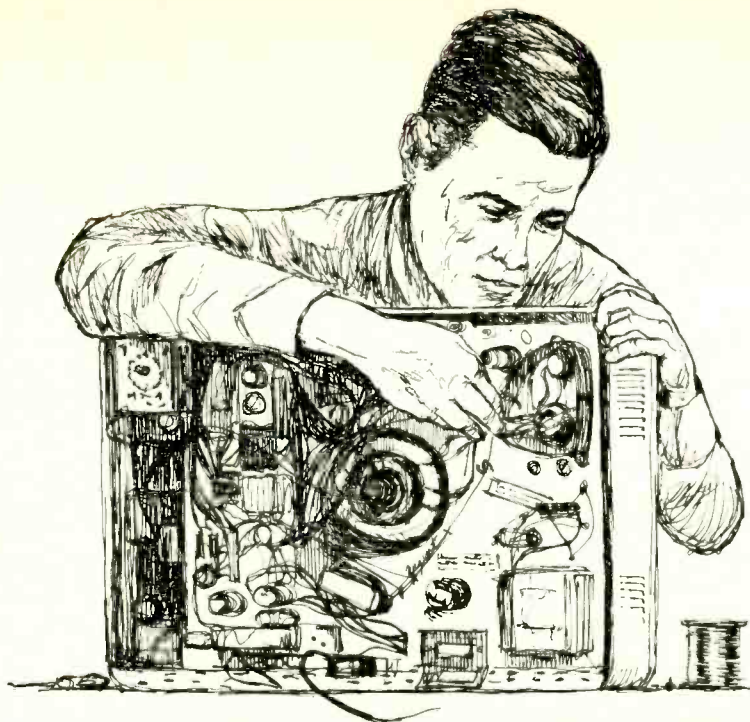

A CHALLENGING INVITATION

for the man who looks to electronics for profitable employment and leisure-time enjoyment . . .

Everyone talks about the great future of Electronics—but how many people are really doing something about it? If you are the one man in seven who is determined to get ahead in electronics—who wants to cash in on the steadily increasing demand for trained technicians—the Electronics Book Club has astonishing benefits for you.

Your membership in this unique book club will help you protect your future . . . increase your knowledge and earning power . . . keep you up-to-date on all the latest electronic developments . . . and bring you greater enjoyment from leisure hours if electronics is your hobby.

Special Invitation

Judge for yourself—without risk—what the Electronics Book Club can do for you, your job, your future. Examine the special introductory offer and exciting membership benefits described on this page. Then mail the coupon without delay. You will receive immediately, 2 valuable handbooks (originally a \$25 home-study course)—yours for only \$2 with membership. If not delighted, return both books in 10 days and forget the matter.

JANUARY, 1966

**GET THESE
2 INCOME-
BOOSTING
BOOKS
FOR ONLY \$2
(originally a \$25
home-study
course).**

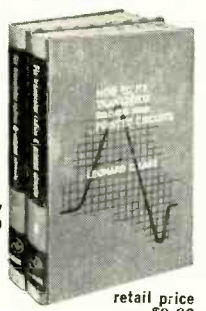

retail price
\$9.90

Here is a **complete** self-training course that tells you everything you want to know on HOW TO FIX TRANSISTOR RADIOS AND PRINTED CIRCUITS. Written by servicing expert Leonard C. Lane, it gives you practical, non-math guidance you can use at once to **spot trouble** in the audio section, **pinpoint** speaker and earphone circuit defects, **check** distortion in the audio amplifier, **locate** front-end troubles, **eliminate** printed-circuit board pitfalls, and work more effectively with signal generator, vtvm, scope and isolation probe.

NOTHING IS LEFT OUT!

These two giant books treat **every** area, much of it new, original, unavailable anywhere else in book form. Reveals answers to every question you've ever had on fixing transistor radios and printed circuits. Hundreds of illustrations and schematics practically turn equipment inside out for you to examine. You get practical tips to save shop time, to lessen servicing trial and error, to find and fix any trouble with professional know-how. So mail coupon for your books today!

YOU RISK NOTHING, NOW OR EVER, BY MAILING COUPON

The purpose of this extraordinary invitation is to demonstrate—*by your own actual experience*—the many benefits you enjoy as a member of the nationally acclaimed Gernsback Electronics Book Club.

Learn more, earn more this easy way:

Every other month the Club's News Bulletin will tell you about a significant new self-teaching book on color TV or radio servicing, test instruments, transistors, hobby projects, stereo, tape recording, industrial electronics, communications, or on some other area of electronics of vital interest to you. Each handbook is a *working tool* designed to help you learn the subject quickly and easily.

Cash savings on books you want!

As a member, *you alone* decide whether you want a particular book or not. You receive 2 books now for only \$2, and you need choose only 4 additional books within a year, out of a wide selection. *The Club saves you up to 30% off retail prices on books you select!*

Free 10-Day Examination!

- ★ Get two valuable books immediately for only \$2.
- ★ Act now! If not pleased, return books in 10 days and forget the matter. Books are always returnable, with no obligation!
- ★ Free charts and tables given with many books.
- ★ Choose only 4 additional books a year, from a wide selection.
- ★ Continuous cash savings, regardless of higher retail prices! So mail coupon now.

Gernsback Electronics Book Club, Dept. 166,
154 West 14 Street, New York, N.Y. 10011

Enroll me in the Electronics Book Club and send me the TWO HANDBOOK SET: How to Fix Transistor Radios and Printed Circuits. Bill me only \$2 plus shipping. If not pleased, I may return both books in 10 days and forget the matter.

As a member, I need only accept as few as 4 additional books within a year—and may resign any time after purchasing these books. All books will be described to me in advance, in the Club Bulletin, and a form will always be provided for my use if I do not wish to receive a forthcoming book. You will bill me the special Club price for each book I take. This will often be as much as 30% off retail prices, plus a few cents postage.

Name

(please print)

Address

City State Zip Code

SAVE POSTAGE COSTS—enclose your payment of \$2 now and we will pay postage. Same return guarantee privilege.

Service

Many service technicians unconsciously plant the seeds of failure in otherwise healthy operations, simply because they never learned these simple facts of good business practice. Regardless of your technical skills, you may find yourself with a losing proposition unless you follow the do's and don'ts prescribed by service editor Jack Darr. He comes to the heart of the thorny credit-risk tragedy in February RADIO-ELECTRONICS and shows how to maintain a thriving business.

Sound

With the discotheque craze sweeping the country, smart technicians and hobbyists are finding a goldmine in setting up and servicing discotheque sound systems. It's simple, direct and astonishingly easy-to-do, once you know the answers outlined by a man who's piloted a project. What you need, what to do, what not to do, how to charge for your services are all included in February RADIO-ELECTRONICS. You'll discover how much audio power you'll need for different sized rooms, how many speakers, where to mount them, tips on controlling reverberation and wall flutter, how to prevent overload distortion, plus hints on turntables, tone arms, phono cartridges, spare parts and servicing.

Sensitivity

Here's an ultrasensitive light meter you can build for under \$10. It all began when this electronics writer, who is also a crack photographer, discovered he needed a simple, extremely sensitive light meter for fine closeup photographs of miniature parts and wiring. When nothing on the market suited his needs, he built his own. And you can too, by following his down-to-earth advice, in February RADIO-ELECTRONICS.

All in February

Radio-Electronics

On sale January 20th—at your favorite newsstands and electronics parts distributors!

TV PIX ON SCOPE ✓ SCREEN PRETTY COMMON

THE RESPONSE TO LAMBERT HUNEALT'S SHORT STORY ("TV Picture on Oscilloscope Screen," October R-E, page 92) was downright overwhelming, in terms of the usual mail response to a published item (except when we goof, which always brings scads of letters).

Turns out that, in contrast to Mr. Huneault's and our thinking, the phenomenon is commonplace. One reader, Victor Castens of Pittsburg, Kans., even went so far as to chide us and Heath's engineers for not having any suggestions about how it occurred.

Practically everybody agreed on the basic setup conditions: scope's horizontal sweep set at 15,750 or 7,875 cycles (the TV horizontal scanning rate or half that), and 60-cycle hum to the scope's vertical plates. But letter writers differed on how the 60-cycle signal was to be got, and most of all on how that all-important video information was going to get in to modulate the beam. The whole puzzle centered around the fact that *there was no connection to the Z-axis (intensity modulation) input* of Mr. Huneault's scope. One reader missed that point. If you use the Z-axis input, you're cheating; after all, what does that give you but a green TV monitor?

Ronald R. Lemanowski of Hamtramck, Mich., wrote: "Enough of the composite video information was getting into the sync. Stray hum was picked up and displaced the beam vertically. The picture was produced by beam displacement. To get a picture on your scope, connect a low-capacitance probe to the video detector output. Use unshielded wire to pick up stray 60-cycle hum, and set the sweep to 15,750 cycles. That's all there is to it."

The most elegant explanation came from Steve Dow of Vancouver, B. C., a frequent contributor to RADIO-ELECTRONICS. Here, greatly condensed, is his version of what happened.

"In the sync circuit of even a good TV you can find a point where vertical and horizontal pulses and clipped video are mixed. Let's take a point where the vertical pulses are greater than the horizontal pulses and the video is lower than both. At such a point, horizontal pulses might be fed to a scope probe by stray capacitance and would have a steep wavefront. This point might be the feed to the vertical integrator in a set with bad age.

"The Health O-10 scope has 5-mc vertical amplifiers, sync fed direct into the sweep oscillator from the vertical amplifiers, retrace blanking direct from the sweep oscillator to an intensity-modulation point on the CRT, and a horizontal oscillator than can sync at any frequency to 500 kc.

"Setting the scope sweep to 15,750 cycles gives us our horizontal scanning. The mixture of vertical, horizontal and video is all going to the vertical plates, but because vertical pulses are the biggest and slowest, they are being seen. This gives frame scanning.

"The video is made of harmonics of the line scan rate (Mertz & Gray theory), so that any video pulse will occur at a specific time during the operation of the scope's sweep multi-vibrator. (Remember that the scope is synced to the TV's horizontal oscillator, which is synced to the video signal.) At this time during the scan of the scope, video is operating the blanking amplifier and thus modulating the beam."

Robert A. Diehl of Fort Wayne, Ind., quotes at length from Robert G. Middleton's book, *101 Ways to Use Your Oscilloscope*. Middleton says that when unshielded test leads are used to get video into the vertical terminals of a scope, the 60-cycle hum picked up causes vertical scanning of the beam, and the video produces a picture on the scope screen by beam displacement, not by intensity modulation. He mentions a few practical situations in which this can happen, and even

shows three pictures of television on a scope screen. That explanation has the virtue of simplicity, at any rate.

Gary Tytler of Hamilton, Ontario, mentions a slightly different experience. "While working on a Philips P-3550 with the picture pulling," he writes, "I connected the scope between the plate of the sync limiter and the first half of the horizontal multivibrator. Lo and behold, there were pictures on the screen.

"I had the scope set at 30 cycles [italics ours—Editor], and between the sync pulses were two fairly clear pictures. My scope is also a Heathkit and the probe was a Heath low-capacitance type."

Now all we need is for someone to write in and tell us he was servicing a wide-band FM tuner with a scope and all of a sudden he saw a perfect full-color TV picture on the scope screen. If somebody does, we won't print it.

BUILD A JIG FOR SPEEDY RECORD-PLAYER SERVICE

The original design of this convenient, easily built adjustable stand for turntables and changers appeared in *Funkschau*, a German service/hobby electronics publication.

Dimensions and materials are given in the drawing. Most of the assembly needs no comment, but the chief feature, the adjustable support post, should be built as shown in the detail.

Drill a hole centered in one end of the post, $\frac{5}{16}$ inch in diameter and about $1\frac{3}{8}$ inches deep. Drill another hole $1\frac{1}{4}$ inches from the same end, through the post so that it intersects the first hole. File out this second hole to make a rectangular channel through the wood approximately $\frac{3}{8}$ inch square (not critical).

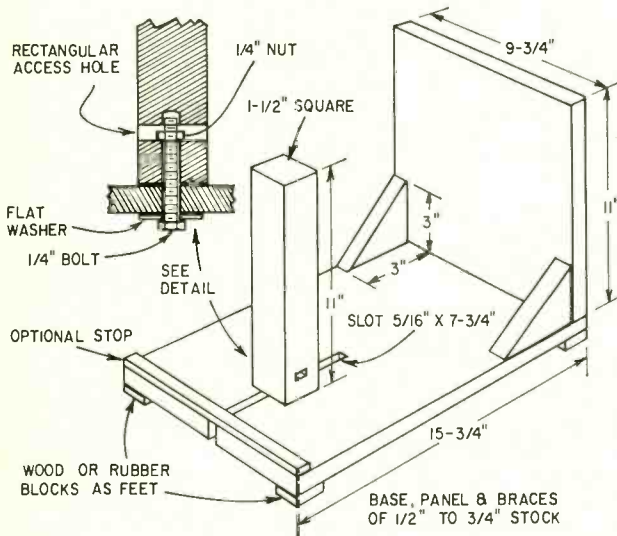

Slip a $\frac{1}{4}$ x 20 hex nut into the rectangular slot so that it rests over the round hole drilled up from the bottom. Push a $\frac{1}{4}$ x 20 bolt about 2 inches long (exact length will depend on the thickness of the bottom board) up through the round hole and thread it a few turns into the nut. (The nut can be held with an open-end wrench or screwdriver tip inserted into the rectangular slot.) Before inserting the bolt, slip a flat washer over it (with an outer diameter of at least 1 inch).

Now slide the post assembly into the slot in the base board, making sure to keep the flat washer on the underside of the board, next to the bolt head. With a little adjustment (and perhaps a little soap), you'll find you can slide the post the length of the slot to accommodate various sizes of turntable and changer chassis. A few small nails driven almost flush into the top of the post will act as stops to prevent changer bases from sliding off it.

The final touch is to install a mirror (preferably unbreakable) in the base, angled so you can see the underside of the player chassis.

END

FIELD ENGINEERS & TECHNICIANS

STATESIDE
AND
OVERSEAS

... Philco's TechRep Division has provided technical support to government and industry for over twenty-four years. The Division continues to offer a variety of employment opportunities and a modern, liberal, benefits program. The following categories are typical of current needs:

- DIGITAL COMPUTERS / DATA PROCESSING
- HEAVY GROUND RADAR
- TELEMETRY & INSTRUMENTATION
- GROUND COMMUNICATIONS
- SHIPBOARD RADAR
- SHIPBOARD COMMUNICATIONS
- SONAR
- PRECISION TEST EQUIPMENT CALIBRATION
- POWER PRODUCTION—DIESEL/STEAM
- GROUND SUPPORT EQUIPMENT
- TECHNICAL WRITERS; TRAINEE TO SENIOR LEVEL

To investigate these opportunities please rush resume in confidence to:

PHILCO TECHREP DIVISION

A SUBSIDIARY OF *Ford Motor Company*

P. O. Box 10, Dept. 804-G, FORT WASHINGTON, PENNA. 19034

An Equal Opportunity Employer

EIGHT INSTRUMENTS IN ONE



- Out-of-Circuit Transistor Analyzer
- Dynamic In-Circuit Transistor & Radio Tester
- Signal Generator
- Signal Tracer • Voltmeter
- Milliammeter
- Battery Tester
- Diode Checker

Transistor Analyzer Model 212

Factory Wired & Tested — \$18.50

Easy-to-Assemble Kit — \$13.50

YOU DON'T NEED A BENCH FULL OF EQUIPMENT TO TEST TRANSISTOR RADIOS! All the facilities you need to check the transistors themselves — and the radios or other circuits in which they are used — have been ingeniously engineered into the compact, 6-inch high case of the Model 212. It's the transistor radio troubleshooter with all the features found only in more expensive units. Find defective transistors and circuit troubles speedily with a single, streamlined instrument instead of an elaborate hook-up.

Features:

Checks all transistor types — high or low power. Checks DC current gain (beta) to 200 in 3 ranges. Checks leakage. Universal test socket accepts different base configurations. Identifies unknown transistors as NPN or PNP.

Dynamic test for all transistors as signal amplifiers (oscillator check), in or out of circuit. Develops test signal for AF, IF, or RF circuits. Signal traces all circuits. Checks condition of diodes. Measures battery or other transistor-circuit power-supply voltages on 12-volt scale. No external power source needed. Measures circuit drain or other DC currents to 80 milliamperes. Supplied with three external leads for in-circuit testing and a pair of test leads for measuring voltage and current. Comes complete with instruction manual and transistor listing.

EMC, 625 Broadway, New York 12, N. Y.

Send me FREE catalog of the complete value-packed EMC line, and name of local distributor.

NAME _____ RE-1

ADDRESS _____

CITY _____ ZONE _____ STATE _____

EMC

ELECTRONIC MEASUREMENTS CORP.
625 Broadway, New York 12, New York
Export: Pan-Mar Corp., 1270 B'way, N. Y. 1

FREE



508 VALUE-PACKED PAGES
including exclusive products and
special values available only
from **ALLIED**

send today for your
ALLIED
1966 CATALOG
world's largest selection

SAVE MOST ON:

*Stereo Hi-Fi
Tape Recording
CB 2-Way Radio
FM-AM & AM Radios
Short Wave Radios
Portable TV • Phonographs
Amateur Gear
Intercoms & P.A.
Automotive Electronics
Test Instruments
TV Tubes & Antennas
Power Tools, Hardware
Parts, Tubes, Transistors*

MORE OF THE BEST IN ELECTRONICS FOR EVERYONE

EASY TERMS
Use the convenient
Allied Credit Fund Plan
—over 24 months to pay

ALLIED RADIO
The World's Largest Electronic Supply House
Circle 124 on reader's service card

*satisfaction
guaranteed or
your money back*

SPECIAL in your **FREE** 1966 ALLIED CATALOG

see what's new in the wonderful world of **knight-kits**[®]

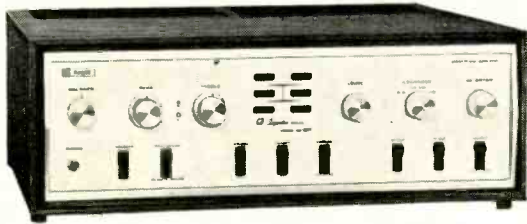

KG-895 Superba Series
120-Watt Solid-State
Stereo Amplifier Kit. \$149.95
(less case)

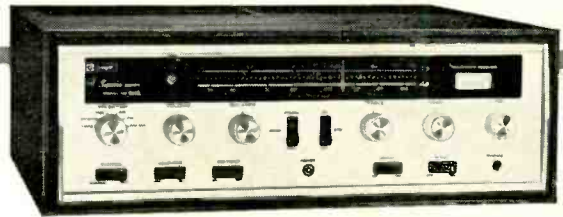

KG-964 Superba
Series 64-Watt Solid-
State FM-AM Stereo
Receiver Kit.
\$189.95
(less case)

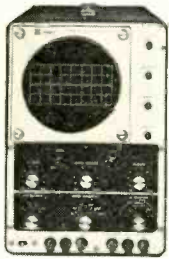

KG-635 5-Inch DC
to 5.2 Mc Wide-
band Oscilloscope
Kit. \$99.95



KG-371 Solid-State
Auto DC Power
Timing Light Kit.
\$19.95

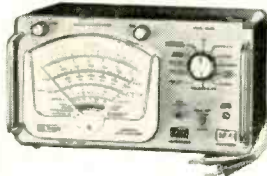

KG-375 Solid-State
Universal Auto Ana-
lyzer Kit. \$49.95



Safari-I Deluxe
23-Channel Citizens
Band Transceiver Kit. \$129.95



C-540 Low-Cost
5-Watt Citizens
Band Transceiver
Kit. \$49.95



KG-221 FM Moni-
tor Receiver Kit
(police, fire, ma-
rine, weather
bands, etc.) \$39.95



KG-201 Solid-State
Motor-Speed/Light
Control Kit. \$9.95

KG-415 Superba
Series Professional
Solid-State Stereo
Tape Deck Kit.
\$249.95
(less case)



Knight-Kit GUARANTEE: Buy any Knight-Kit. Build it. Operate it. You must be satisfied or we refund your money.

THERE IS A knight-kit FOR EVERY NEED!
easiest to build—enjoy big savings

- Stereo Hi-Fi
- CB 2-Way Radio
- Short-Wave
- Hobby Kits
- Test Equipment
- Automotive
- Intercom
- Amateur Gear

FREE

Send today for your
508-page Allied 1966
value-packed catalog



send for your 508-page 1966 Allied Catalog

FREE!

ALLIED RADIO, Dept. 2-A
100 N. Western Ave., Chicago, Ill. 60680

Send FREE 1966 Allied Catalog

Name _____
PLEASE PRINT

Address _____

City _____ State _____ Zip _____

ALLIED RADIO

not all sets. So long as there is a substantial price differential between color and monochrome, black-and-white sets will continue to sell in heavy volume.

There must come a day when color will completely supplant the black-and-white TV receiver. But that won't come about without that offspring of necessity—invention.

It seems almost inevitable that there must be a "second generation" of color sets if color is to sweep the field. The new system, or systems, to be acceptable, must make these promises:

1. Substantial cost reduction, to a level perhaps 25% higher than that of a comparable black-and-white receiver.
2. Reliability at least equal to the present system.
3. Capability of producing far greater brightness.
4. Power requirements low enough for battery operation.

The boom in color has shifted the electronics spotlight to consumer products for the first time in more than a decade. Since the consumer segment is now the fastest-growing part of the electronics field, it can no longer be the stepchild of the industry in terms of research and development. There is now a very strong possibility that electronic innovations will be aimed directly at consumer products—specifically color TV.

Actually, there are two approaches to color TV in commercial production today—the shadow-mask tube and the Chromatron, or Lawrence tube—the latter now being produced in limited quantities in Japan. Although some Chromatron-type receivers may well reach the United States, American picture-tube and receiver manufacturers have almost unanimously rejected this approach. It seems unlikely that it will now be given serious consideration in this country, in view of the well established and proven status of the shadow-mask design. The next major departure in color TV should, indeed, be far more significant than a switch to the Chromatron, with its mixed bag of blessings and drawbacks.

The shadow-mask tube and the existing circuits, without radical changes, may continue to serve the public's needs for the next few years. But the receiver of the 1970's could show a major departure from traditional design. Integrated circuitry, in large-volume production, can substantially cut costs as well as improve reliability and reduce weight and bulk. Although progress in electroluminescent display systems has been disappointingly slow, the potential rewards for a new, simple and compact color-TV screen are so great that they are accelerating developments.

Whether the electroluminescent panel will be the answer is, of course, not yet known. But the color picture tube of today is destined somehow to be retired to pasture. A true "thin" or "flat" tube may hold promise. New versions of projection TV are being explored, including one that uses low-cost plastic lenses and a special distortion corrector, and another that eliminates the cathode-ray tube by using a layer of viscous fluid to modulate an external light source.

Without a transfusion of substantial invention and innovation, the bloom will come off color's rose some time in the 1970's. The TV manufacturing industry is beginning to realize this and, as never before, the search is on for the new answer to the receiver for the all-color era.

That answer will be found, and some time after 1970 it is possible that no more black-and-white entertainment TV sets will be made—excepting possibly monochrome pocket portables.

In terms of consumer purchasing, color is growing at a rate faster than that set by black-and-white in TV's early boom days. In 1965, the public spent more for color than for monochrome sets. If the industry's scientific and technical skills can keep pace with its marketing ability, the color boom will last another 10 years, or longer. END



**Fastest
heating**

gun in the world

A Weller gun reaches full soldering temperature up to 40% faster than other guns. This is just one of the reasons why Weller is the choice of nearly all professional electronic service technicians.

Weller guns also have trigger-controlled dual heat that permits instant switching to high or low heat to suit the job. They deliver the most heat per rated watt, resulting in the greatest soldering efficiency.

When you buy a soldering gun, be sure to insist on Weller.

Weller Dual Heat Guns and Kits come in wattage ranges from 100 to 325, priced from \$6.95 to \$12.95 list.

Weller[®]

WELLER ELECTRIC CORP., EASTON, PA.

In England: Horsham, Sussex

World Leader in Soldering Technology

Circle 125 on reader's service card

TRY THIS ONE

THEY SAID IT COULDN'T BE DONE. . . . ✓

The radio was a Titan model TMA 70, a tube-transistor hybrid. I acquired it when it was taken out of a Chevy pickup truck during installation of Citizens-band equipment. I figured it would look nice in a certain '62 Volkswagen, except that the Chevy's battery was 12 volts and the VW's only 6. So the set sat while various voltage-boosting circuits were contemplated. Whoever heard of operating tubes on only 6 volts plate supply?

After nearly deciding on a transistor converter circuit, I thought it wise to check out the radio on its normal 12 volts with a variable dc power supply. Performance was excellent. Now came the thought, why not see how low I can bring the voltage before the audio becomes inaudible or

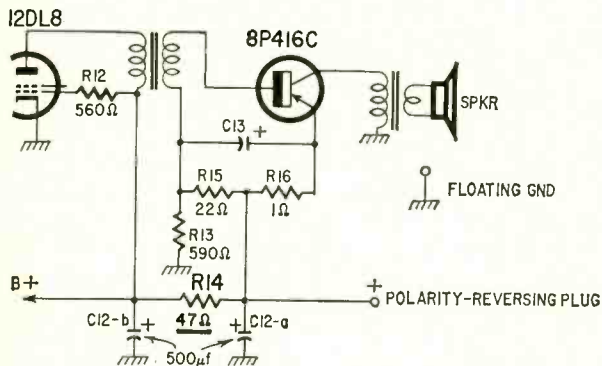

the local oscillator drops out? Down went the voltage, and with it the volume. At 8 volts, there was still output. Finally at 6 volts, two local stations could still be heard, faintly, and with the help of a long outdoor antenna. Could something be done to improve reception to an acceptable level at 6 volts?

First, I checked the tubes. All were in top condition, so no room for improvement here. Next came the power transistor, identified only as 8P416C. Several replacements were tried, including types 2N256, 2N268A and 2N554, but none equaled the original in output.

Circuit changes were necessary. But any increase in volume was bought at the price of greater distortion. At this point, I noticed R14, a 47-ohm resistor, forming a filter for the B+ with two 500-μf capacitor sections. Shorting out this resistor doubled the volume, bringing in many new stations. It is possible that switching the plate and screen supply connections of the 12DL8 detector-amplifier tube to the other side of the resistor would have done a similar thing. Since a 5-foot antenna now was sufficient, it remained only to replace the 12-volt pilot lamp with a 6-volt type. Warmup time does not exceed 60 to 70 seconds.

I do not claim that every 12-volt car radio can be made to operate on 6 volts, but at least there's no reason for not trying.—F. W. Chesson

CORRECTING LOW-LEVEL STEREO UNBALANCE

A trouble in stereo amplifiers with single gain and balance controls is low-level unbalance. At low-level settings, one channel is louder than the other. The cause is small wiper-to-ground resistance differences on the two tandem-mounted pots. To alter the mechanical position of the wiper arms is usually impossible. As this occurs only at

at last...
instant color patterns
at your finger tips...
zero warm-up time



THE ALL NEW SENCORE CG135 DELUXE TRANSISTORIZED COLOR GENERATOR

The big push is on in Color TV. Equip yourself now with the new, solid state Sencore CG135 and cash in on the zooming volume of new service business as Color-TV booms! Instant, service-ready RCA standard color bars, cross-hatch, white dots and individual vertical and horizontal bars enable you to set up or trouble-shoot more Color TV sets per day; earn top money in this fast growing service field. It's an analyzer too: Color gun interruptors, unmodulated video for chroma circuit trouble isolation and unmodulated sync pulses to keep Zenith receivers in sync for this test, make color trouble shooting a snap. Sturdy all-steel construction for rugged, heavy duty in the field or shop. Another Best Buy in profit-building service instruments. **\$149⁹⁵** from Sencore at

COMPARE THESE FEATURES: SEE WHY THE CG135 IS IN A CLASS BY ITSELF

- Solid state construction employs high priced GE "Unijunctions" to develop six "jump out proof counters" that guarantee stable patterns at all times with no warm-up
- Standard RCA licensed patterns as shown on schematics throughout the industry
- Handy universal color gun interruptors on front panel
- Lead piercing clips insure non-obsolence
- CRT adaptors optional
- Crystal-Controlled 4.5mc Sound Carrier Analyzing Signal to insure correct setting of fine tuning control
- RF output on Channel 4 adjustable to Channel 3 or 5 from front of generator when Channel 4 is being used
- No batteries to run down; uses 115 V AC
- Less than one foot square, weighs only 8 lbs.

professional quality — that's the difference!

SENCORE

426 SOUTH WESTGATE DRIVE • ADDISON, ILLINOIS

Circle 126 on reader's service card

Me...? Rebuild Color Tubes???

Why Not!

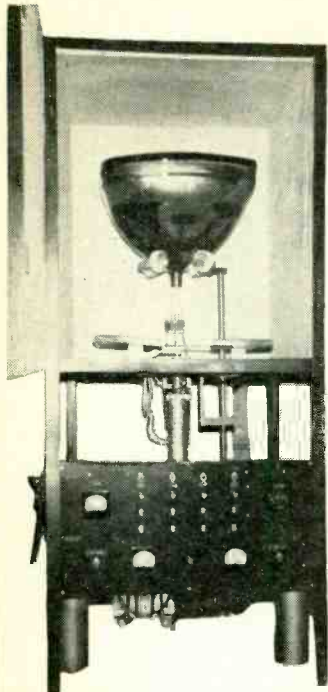

**Windsor Equipment
Handles Color & Bond-
ed-Face As Well As
Black-and-White Tubes.**

So What?

Rebuilding with Wind-
sor is a **QUALITY
PROCESS . . . and
PROFITABLE !!!**

Rebuild Color Tubes for
a Cost of \$11.75 each
. . . You sell them for???

**Windsor Equipment
pays for itself in a few
months.**

**Financing Available
Free Training at our
Plant**

Write for our Booklet "The Open Door to TV Profits"

WINDSOR ELECTRONICS, INC.

Equipment Division
999 N. Main St., Glen Ellyn, Illinois

Circle 127 on reader's service card

BE ON THE ALERT! with SONAR FM MONITOR RECEIVER

wired
for
"Tone
Alert."



**HAND WIRED
•
LOW COST &
GIVES HIGH
PERFORMANCE**

Monitor the calls and know
the facts as it happens.

NOW!—8 Super Deluxe FM communication receivers to meet your particular needs for home, office or car. Powerful and dependable. Engineered for rugged service under all operating conditions. Featuring High frequency oscillator, temperature compensated for stability, RF amplifier for maximum sensitivity, illuminated dial, safety rated components and ALL Aluminum construction plus many other outstanding features. Operates on 110 VAC. Includes power cord, mounting bracket.

Model FR-101—(25-50 mc)
Model FR-102—(150-175 mc)

\$89.95

TUNABLE
RECEIVER
AC Only

Slightly higher prices for DC and XTAL control

SONAR RADIO CORPORATION
73 Wortman Ave., Brooklyn 7, N.Y. Dept. 442
Please send me information on Model
FR101/102 Monitor Receiver.

Name.....
Address.....
City..... Zone..... State.....



Circle 128 on reader's service card

low-level settings, inserting resistance in the louder channel circuit will surely affect the normal, higher settings of the gain control. The balance control could be used to correct this level difference, but customers find it difficult to understand why this should be necessary in new units.

It is possible to balance low-resistance wiper-to-ground differences on the tandem controls by applying silver paint on both elements at the start of rotation. The paint is applied and allowed to dry. Then dip a cotton swab into acetone and remove the excess a little at a time. Each time ink is removed, measure resistance. Get the two sections to within about 10%. This moves the zero position up a few degrees, but effectively balances the few hundred ohms difference at the low end.—*Steve Dow*

SERIES DIODE CUTS SOLDERING HEAT

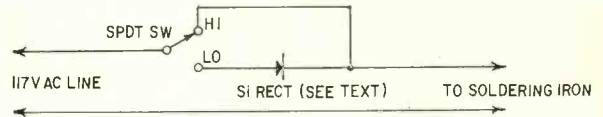

An efficient way to reduce the heat of any ordinary soldering iron is to connect a silicon rectifier in series with it, as shown in the diagram. Reduced heat will lessen oxidation of the tip during long standby periods, and will often be high enough for soldering delicate parts without damage.

A 200-volt diode will do: current rating depends on the demands of the iron. A 1N2069 is fine for 30- to 40-watt irons.—*Herbert E. Pasch*

PASSIVE "BOOSTER" PERKS UP RADIO DEMONSTRATIONS

This suggestion for radio dealers and service shops appeared in *Graetz Nachrichten*, a service publication of Graetz GmbH, a German radio-TV manufacturer:

If you work in a steel-frame building and you want to demonstrate an AM transistor portable to a prospective customer, or check out a repaired one in the owner's presence, the showing is likely to be unconvincing if the radio picks up only half as many stations and twice as much noise as usual, because of the shielding from the building's frame.

Try taping a long piece of any kind of wire, in a random, zigzag fashion, to the underside of a table or counter, on which you'll put the radio for all such demonstrations. Connect one end of this wire to an outside long-wire antenna—you may have to experiment. The wire will induce enough extra signal in the radio's built-in antenna to put performance near normal. If the table has a metal top, try connecting the outside antenna to it.—*Pete Sutheim*

TRANSMISSION-LINE SPLITTER

Extremely wide-band line splitters with any number of branches may be designed readily with the network configu-

HOW TO KEEP A SERVICE SHOP OPEN

Good will, technical know-how, enthusiasm and capital won't be enough! Courting bad credit risks and deadbeats can throw a new shop out of business in less than a year! Read Service Editor Jack Darr's simple approach to staying in the black!

**Coming in February
RADIO-ELECTRONICS**

ration composed entirely of resistors, shown below. All resistors are equal, and their value is given by

$$R = Z \left(\frac{N-1}{N+1} \right)$$

where Z is the line impedance and N is the number of branches.

Attenuation, expressed as a voltage ratio, is equal to 1/N.

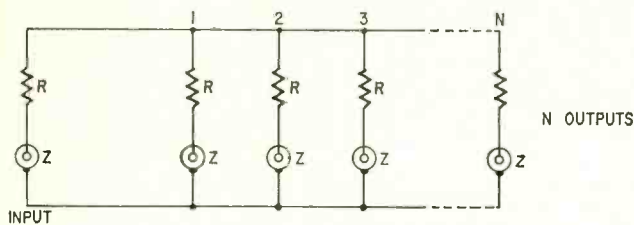

For balanced lines, resistors of value R/2 are placed in each side of the line.

The upper limit of frequency response is determined primarily by stray inductance and capacitance, if the resistors themselves are reasonably good. Minimize both for either high frequencies or extremely accurate impedance matches.—Donald H. Rogers

RUBBER CEMENT CATCHES DRILLING CHIPS

Dab rubber cement on the chassis where a hole is to be drilled. The cement catches and holds chips, preventing them from dropping into adjacent wiring or components. The cement dries as you drill and peels off easily later.—H. Josephs

MAKING BANDSPREAD DIALS MORE CONVENIENT

Many short-wave receivers have bandspread tuning dials with calibration from 0 to 100, and designed to be set at one end for normal tuning. However, it would be convenient if the set point were at the middle of the dial, so that the bandspread control could be used for fine tuning in either direction from the setting of the main tuning dial. To do this, set the bandspread dial to 50 and readjust the oscillator trimmer to return the main tuning dial to correct calibration.

If the oscillator trimmer does not have enough range, the set point will have to be placed at some place between 50 and the previous set point. Note that this idea does not apply if the bandspread dial carries actual frequency calibrations.—Charles Erwin Cohn

END

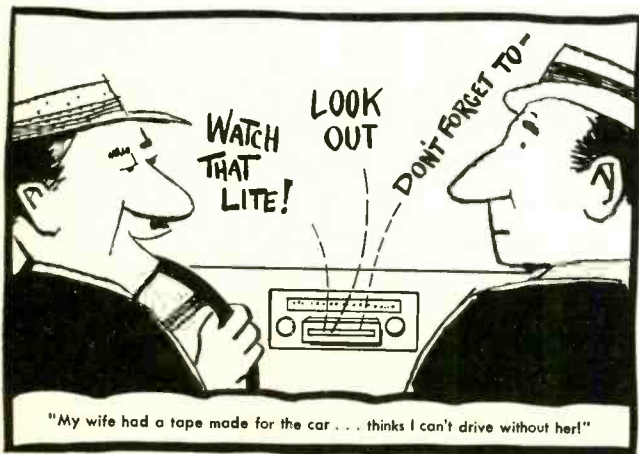

Nontronics Headliner

it's here! most advanced
color TV test instrument
ever developed



- OBSOLETE ALL OTHERS
- ELIMINATES ALL GUESSWORK

LECTROTECH V7*

A sensational new color generator with 4 major Lectrotech exclusives . . . plus all of the time-proven standard features . . . in one compact, portable unit. For the first time, you can install and service color TV completely, accurately and faster! Here are the facts:

EXCLUSIVE—COLOR VECTORSCOPE—Until now, available only in \$1500 testers designed for broadcast. Accurately measures color demodulation to check R-Y and B-Y plus all 10 color bars for color phase angles and amplitude. A must for total color and those hard to get skin tones.

EXCLUSIVE—SELF-CALIBRATING—Adjust timing circuit without the use of external test equipment. No need to return unit to a factory for adjustment.

EXCLUSIVE—DIAL-A-LINE—Now, you can adjust horizontal line to any width desired from 1 to 4 lines wide.

EXCLUSIVE—SOLID STATE RELIABILITY—Only two tubes are used in combination with fully transistorized diode-rectifier circuit.

PLUS— the V7 produces all Crosshatch, Dots, Vertical only, Horizontal only and Keyed Rainbow Patterns. RF at channels 3, 4 or 5. Video Output (Pos. and Neg. adjustable) for signal injection trouble-shooting. Red-Blue-Green Gun Killer. All transistor and timer circuits are voltage regulated to operate under wide voltage ranges. Lightweight, compact — only 8¼" x 7½" x 12½". Net. 189.50

ONE YEAR WARRANTY

For the full story on the V7, write for complete catalog or see your distributor.

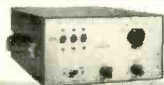

V6 Complete color bar generator with all the features of the Lectrotech V7 except the Vectorscope. Only 99.50



Distributors: Phone or Wire Collect.

LECTROTECH, INC.

Dept. RE-1

1221 Devon Ave. ■ Chicago, Ill. 60626 ■ Area 312 764-7005

Circle 129 on reader's service card

TECHNOTES

MODIFICATION TO CTC15 (REMOTE) VOLUME CONTROL

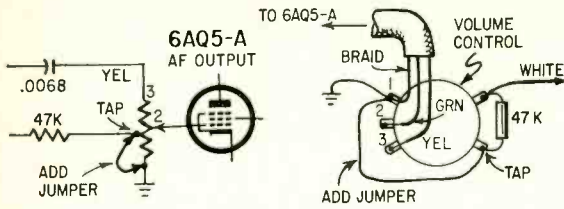

The RCA CTC15 color chassis with remote control uses two cam switches mounted on the volume-control shaft. When the volume is reduced, the cams operate and turn off the set. The cams prevent turning "off" the sound unless the whole set is turned off. This is very annoying to people who wish to kill the sound for a while, without turning off the pix.

An effective remedy is to run a jumper from the fixed tap on the volume pot to the ground lead on pin 1.

When the volume control slider is turned to the point where the tap is, the sound will be completely off.

This quick fix will slightly degrade tone-control action, but the benefit of being able to turn off the volume far outweighs the objection.—*J. M. Bruning*

DEAD NORELCO EL3542-A RECORDER

If there is no recording or playback on this machine, just a hum in the speaker, the contacts of RY1, the control

relay, have probably welded shut, shunting trip magnet RY2 across the B-plus supply.

Pull the contacts apart and burnish them lightly to remove burrs. Check the armature spring for cracks; check

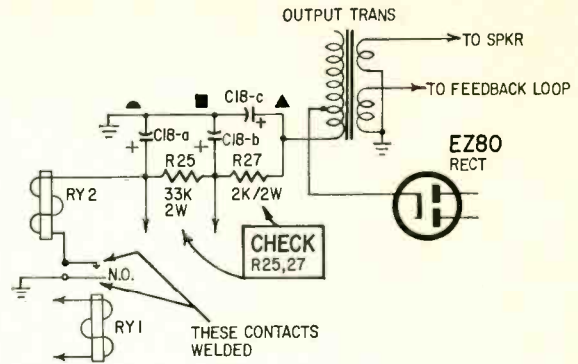

R25, R27 for damage. RY1 is accessible from the top of the machine, to the lower left of the takeup spindle. R25 is across two terminals of the electrolytic, and R27 is near the output transformer. Both are accessible from the bottom without dismantling the entire machine.—*Steve P. Dow*

RCA CTC10-C FADES OUT

An RCA CTC10-C had been getting progressively dimmer and was in constant need of gray-scale adjustment. Finally it got so bad that a picture could be seen only at full brightness setting. The set would go almost black at times, with no apparent pattern to the behavior. All high-voltage and brightness circuits checked out OK.

MOVING DATE EXTENDED—SALE CONTINUES

FREE \$1 BUY WITH EVERY 10 YOU ORDER

Only applies to "\$1" Buys

FREE GIFT WITH EVERY ORDER

- 1000—ASST. HARDWARE KIT \$1
screws, nuts, washers, rivets, etc.
- 250—ASST. SOLDERING LUGS \$1
best types and sizes
- 250—ASST. WOOD SCREWS \$1
finest popular selection
- 250 — ASST. SELF TAPPING SCREWS \$1
#6, #8, etc.
- 150—ASST. 6/32 SCREWS and 150 6/32 HEX NUTS \$1
- 150—ASST. 8/32 SCREWS and 150—8/32 HEX NUTS \$1
- 150—6/32 HEX NUTS and 150—8/32 HEX NUTS \$1
- 150—ASST. 2/56 SCREWS and 150—2/56 HEX NUTS \$1
- 150—ASST. 4/40 SCREWS and 150—4/40 HEX NUTS \$1
- 150—ASST. 5/40 SCREWS and 150—5/40 HEX NUTS \$1
- 500—ASSORTED RIVETS \$1
most useful selected sizes
- 500—ASSORTED WASHERS \$1
most useful selected sizes
- 100 — ASST. RUBBER & FELT FEET FOR CABINETS \$1
best sizes
- 10—ASSORTED SLIDE SWITCHES \$1
SPST, SPDT, DPDT, etc.
- CHAPT ZU DI MITZIA "JACKPOT" \$1
double your money back if not completely satisfied
- BONANZA "JACKPOT" not gold, not oil, but a wealth of Electronic Items—Money-Back-guarantee \$5
- 100'—MINIATURE ZIP CORD \$1
2 conductor, serves 101 uses
- 50 ASSORTED MYLAR CONDENSERS \$1
Popular types .001 to .47
- 10 SETS — DELUXE PLUGS & JACKS \$1
asst. for many purposes
- 10 — SETS PHONO PLUGS & PIN JACKS \$1
RCA type
- 10 — SURE-GRIP ALLIGATOR CLIPS \$1
2" plated
- 4—50' SPOOLS HOOK-UP WIRE \$1
4 different colors
- 200'—BUSS WIRE #20 tinned for hookups, special circuits, etc. \$1
- 50 — STRIPS ASSORTED SPAGHETTI \$1
handy sizes
- 100—ASSORTED RUBBER GROMMETS \$1
best sizes
- 50—ASSORTED PRINTED CIRCUIT SOCKETS \$1
best types
- 3—1/2 MEG VOLUME CONTROLS \$1
with switch, 3" shaft
- 20—ASSORTED VOLUME CONTROLS \$1
less switch
- 7—ASSORTED VOLUME CONTROLS \$1
with switch
- 15—RADIO OSCILLATOR COILS \$1
standard 456kc
- 20—ASST. PILOT LIGHTS \$1
#44, 46, 47, 51, etc.

TV BARGAIN COLUMN

- 3—MALLORY 80-450v ELECTROLYTIC CONDENSERS \$1
(sparkling new) top item for TV and amplifiers
- 10—ASST UHF TUNER STRIPS \$1
standard 16 to 67 \$50 value
- RCA 110° FLYBACK TRANSF. \$3
for all type TV's incl schematic
- 110° TV DEFLECTION YOKE \$2
for all type TV's incl schematic
- 90° FLYBACK TRANSFORMER \$1
for all type TV's incl schematic
- 90° TV DEFLECTION YOKE \$1
for all type TV's incl schematic
- 70° FLYBACK TRANSFORMER \$1
for all type TV's incl schematic
- 70° TV DEFLECTION YOKE \$1
for all type TV's incl schematic
- 4 — TV ALIGNMENT TOOLS \$1
most useful assortment
- 20—ASSORTED TV COILS \$1
I.F. video, sound, ratio, etc.
- 40—ASSORTED TV KNOBS \$1
all standard types, \$20 value
- 20—ASSORTED GRID CAPS \$1
for 1B3, 1X2, 6BQ6, 6BQ6, etc.
- 50—ASSORTED TV PEAKING COILS \$1
all popular types
- \$15.00 TELEVISION PARTS \$1
"JACKPOT" best buy ever

MARKET SCOOP COLUMN

- U-15 BSR RECORD CHANGER \$14
complete with dual sapphire arm
- \$10 QUAM 8" PM SPEAKER \$3
Top quality 6oz ceramic mag.
- \$14 QUAM 12" PM SPEAKER \$5
Top quality. 10oz ceramic mag.
- TRANSISTOR RADIO \$1.50
asst type good, bad, broken, as-is, potluck
- TAPE RECORDER—assorted types \$4
good, bad, broken, as-is, potluck
- 10—ASSORTED DIODE CRYSTALS \$1
1N34, 1N48, 1N60, 1N64, 1N82
- 10—TOP BRAND TRANSISTORS \$1
NPN & PNP 2N404, 2N414, etc.
- 1 — SQ. YARD GRILLE CLOTH \$1
most popular brown & gold design
- TELEPHONE RECORDING DEVICE \$1
place it under telephone
- CRYSTAL LAPEL MICROPHONE \$1
high impedance, 200-6000 cps
- 10 — ASST. RADIO ELECTROLYTIC CONDENSERS \$1
- 7 — ASST. TV ELECTROLYTIC CONDENSERS \$1
popular selection
- 50 — ASST. TUBULAR CONDENSERS \$1
.001 to .47 to 600v

IMMEDIATE DELIVERY . . . Scientific light packing for safe delivery at minimum cost.
HANDY WAY TO ORDER: Pencil mark or write amounts wanted in each box, place letter F in box for Free \$1 BUY. Enclose with check or money order, add extra for shipping. Tearsheets will be returned as packing slips in your order, plus lists of new offers.

Name
Address
Cost of goods
Shipping
estimated
TOTAL

Please specify refund on shipping overpayment desired: CHECK POSTAGE STAMPS MERCHANDISE (our choice) with advantage to customer

The solution finally lay with the series pair of NE-2 neon lamps connected from the brightness control circuit to ground. Although they appeared to be lighting normally, one or both had evidently aged and changed characteristics. Replacing both cured the trouble.

If you make such a change, you will have to readjust the high-voltage regulator current and the horizontal output and check the horizontal-oscillator waveform. I'd recommend a complete color-section alignment.—*Robert W. Bachman*

**DISTORTED SOUND, NO VIDEO
IN HEATH COLOR TV**

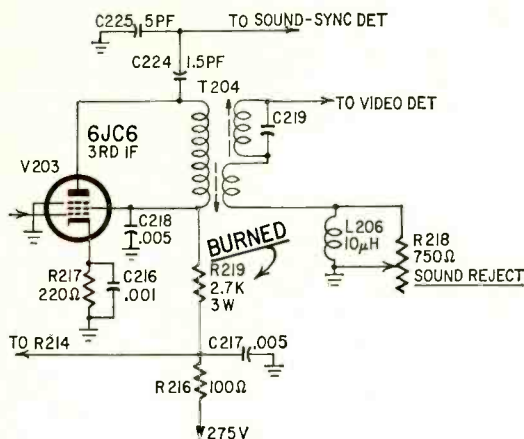

I ran into a rather unusual problem with a Heath GR-53 color set.
The conditions were: sufficient audio, though slightly

distorted; a raster, but no video. Since this set uses an inter-carrier i.f. system, the i.f. stages were pretty well out as a source of trouble. However, a 400-cycle signal injected into any of the video circuits produced distinct bars, and a 3.58-mc signal injected on either side of the video-detector diode produced color bars; so the video detector and circuits beyond were eliminated.

Re-examining the i.f.'s, I found there was almost no plate or screen voltage on the 6JC6, and R219 showed a whitish ring around it where overheating had bleached it. A control-grid-to-screen-grid short was found in the 6JC6; the circuit diagram shows how audio was received at the sound-sync detector.—*Gary Gustafson*

MANUFACTURERS' COLOR SERVICE NOTES

G-E—all chassis: reports from the field stressed a drift in color purity after the set was on for 2 or 3 hours. This produced a bright pink area on the right side of the screen. Engineers determined the cause to be insufficient warmup before setup. Every receiver should be warmed up for 20 minutes with the back fastened before any purity adjustments are made.—*G-E Service Talk, Vol. 7, No. 7, July 1965.*

Philco—15M91D, 16M91: In case one of these chassis needs CRT setup because of rough handling or accidental magnetization during shipping, follow the directions on pages 1-5 of PR3917 with this addition: Before you put the set in its final position in the customer's home, face it *north* or *south* for external degaussing and purity adjustments. This lets the internal automatic degausser perform at maximum efficiency to correct for magnetization in the final location, and for accidental magnetization from home appliances.—*Philco TV Service Bulletin TV7-65*

END

SARKES TARZIAN TV TUNER 41mc



Latest Compact Model—good for all 41 mc TV's.
BRAND NEW—MONEY BACK GUARANTEE

Best TUNER "SARKES TARZIAN" ever made—last word for stability, definition & smoothness of operation. An opportunity—to improve and bring your TV Receiver up-to-date.

COMPLETE with Tubes & Schematic .. \$7.95

RCA 110° FLYBACK TRANSFORMER



We scooped the Market on 10000 Latest type RCA—standard for all 110° TV's—also good for 90° TV's
RCA's design of extra large Coil produces upwards of 18KV—assuring adequate width
Included — Schematic Diagram showing easy application for any TV
List price \$13.90

Your price ... \$3

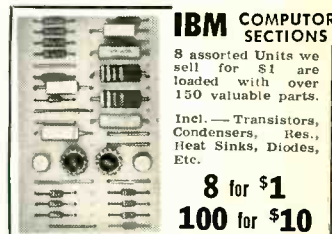

IBM COMPUTER SECTIONS

8 assorted Units we sell for \$1 are loaded with over 150 valuable parts.
Incl.—Transistors, Condensers, Res., Heat Sinks, Diodes, Etc.

8 for \$1
100 for \$10

- | | | | |
|--|--|--|--|
| <input type="checkbox"/> UNIVERSAL 4" PM SPEAKER
Alnico 5 magnet, quality tone ... 69¢ | <input type="checkbox"/> 100 — ASST. CERAMIC CONDENSERS
some in 5% ... \$1 | <input type="checkbox"/> \$15.00 RADIO PARTS "JACK-
POT" handy assortment ... \$1 | <input type="checkbox"/> 4—SHOCKPROOF SCREWDRIV-
ERS best sizes incl Phillips ... \$1 |
| <input type="checkbox"/> UNIV. 3" x 5" PM SPEAKER
Best type for Radios, TV, Etc. ... 75¢ | <input type="checkbox"/> 100 — ASST. MICA CONDENSERS
some in 5% ... \$1 | <input type="checkbox"/> 20—ITT SELENIUM RECTIFIERS
65ma for Radios, Meters, Chargers,
Transistors, Experiments, etc. ... \$1 | <input type="checkbox"/> 7 — ASST. 4 WATT WIRE
WOUND CONTROLS ... \$1 |
| <input type="checkbox"/> 300—ASST. 1/2 W RESISTORS
Top Brand, Short leads, excellent ... \$1 | <input type="checkbox"/> 100—ASST 1/4 WATT RESISTORS
stand. choice ohmages, some in 5% ... \$1 | <input type="checkbox"/> 20 — ASSORTED TUBES
Radio, Television and Industrial ... \$1 | <input type="checkbox"/> 4—TRANSISTOR RADIO EAR-
PIECES wired complete with plug ... \$1 |
| <input type="checkbox"/> 100—MOLDED TUBULAR COND.
Top brand, short leads, excellent ... \$1 | <input type="checkbox"/> 100—ASST 1/2 WATT RESISTORS
stand. choice ohmages, some in 5% ... \$1 | <input type="checkbox"/> 50 — WHITE TUBE CARTONS
Asst. for all 4 important sizes ... \$1 | <input type="checkbox"/> 2—G.E. PIECES OF EQUIPMENT
stacked with over 200 useful parts ... \$1 |
| <input type="checkbox"/> 50—ASSORTED #3AG FUSES
Popular assorted ampere ratings ... \$1 | <input type="checkbox"/> 70—ASST 1 WATT RESISTORS
stand. choice ohmages, some in 5% ... \$1 | <input type="checkbox"/> ALL AMERICAN TUBE KIT
Top Standard Brand — 12BA8,
12BE6, 12AV6, 50C5, 35W4 ... \$2 | <input type="checkbox"/> 20 — EXPERIMENTER'S COIL
"JACKPOT" assorted for 101 uses ... \$1 |
| <input type="checkbox"/> 5—I.F. COIL TRANSFORMERS
stand. for Transistor Radios ... \$1 | <input type="checkbox"/> 35—ASST 2 WATT RESISTORS
stand. choice ohmages, some in 5% ... \$1 | <input type="checkbox"/> 3 — TOP BRAND 35W4 TUBES ... \$1 | <input type="checkbox"/> 50—G.E. FLASHLIGHT BULBS
#PR-9, 2.7 volts ... \$1 |
| <input type="checkbox"/> 5 — AUDIO OUTPUT TRANS-
FORM sub-min for Trans Radios ... \$1 | <input type="checkbox"/> 50—PRECISION RESISTORS
asst. list-price \$50 less 98% ... \$1 | <input type="checkbox"/> 5—RCA 1U4 TUBES brand new
boxed, also serves as a 1T4 ... \$1 | <input type="checkbox"/> 5—ASSORTED TRANSFORMERS
Radio, TV and Industrial ... \$1 |
| <input type="checkbox"/> 4—TOGGLE SWITCHES
SPST, SPDT, DPST, DPDT ... \$1 | <input type="checkbox"/> 20 — ASS'TED WIREWOUND
RESISTORS, 5, 10, 20 watt ... \$1 | <input type="checkbox"/> 25 — SYLVANIA HEAT SINKS
for Transistors, etc. ... \$1 | <input type="checkbox"/> 5—G.E. SAPPHIRE NEEDLES
4G, VR-11, etc. (\$10.50 value) ... \$1 |
| <input type="checkbox"/> 15—ASST. ROTARY SWITCHES
all popular types \$20 value ... \$1 | <input type="checkbox"/> 100—ASST. TERMINAL STRIPS
all types, 1-lug to 6-lug ... \$1 | <input type="checkbox"/> 100—BRASS FAHNSTOCK CLIPS
popular type & size, plated ... \$1 | <input type="checkbox"/> RONETTE SAPPHIRE CARTRIDGE
dual flipover type—value \$5 ... \$1 |
| <input type="checkbox"/> 50—RADIO & TV SOCKETS
all type 7 pin, 8 pin, 9 pin, etc. ... \$1 | <input type="checkbox"/> 25 — INSTRUMENT POINTER
KNOBS selected popular types ... \$1 | <input type="checkbox"/> 3 — ELECTROLYTIC CONDEN-
SERS 50/30-150v ... \$1 | <input type="checkbox"/> RONETTE STEREO CARTRIDGE
latest dual sapphire flipover type ... \$2 |
| <input type="checkbox"/> 2—UNIV. 2" PM SPEAKERS
for Radios, Multiple Speakers, Etc. ... \$1 | <input type="checkbox"/> 50—ASST. RADIO KNOBS
all selected popular types ... \$1 | <input type="checkbox"/> 6 — TV ELECTROLYTIC CON-
DENSERS Sprague 80-175v ... \$1 | <input type="checkbox"/> 3—SAPPHIRE STYLUS NEEDLES
Ronette type for most cartridges ... \$1 |
| <input type="checkbox"/> UNIVERSAL 4" PM TWEETER
SPEAKER for FM, Hi-Fi, etc. ... \$1 | <input type="checkbox"/> 5—PNP TRANSISTORS
general purpose, TO-5 case ... \$1 | <input type="checkbox"/> 2—POWER TRANSISTORS No. 1
Replace 2N155, 2N176, 2N301, etc. ... \$1 | <input type="checkbox"/> 3—STANDARD SAPPHIRE NEED-
LES for all thumbscrew cartridges ... \$1 |
| <input type="checkbox"/> 10—SPEAKER PLUG SETS
deluxe type, 2 conductor, wired ... \$1 | <input type="checkbox"/> 5—NPN TRANSISTORS
general purpose, TO-5 case ... \$1 | <input type="checkbox"/> 5—LINE FILTER COILS 110v, to
117v, 2.5mh, dual, many uses ... \$1 | <input type="checkbox"/> 50—BALL POINT PENS
Retractable, assorted colors ... \$1 |
| <input type="checkbox"/> CLEAN UP THE KITCHEN "JACK-
POT" Big Deal ... \$1 | <input type="checkbox"/> 50—RCA LUCITE RADIO KNOBS
popular type w. indicator pointer ... \$1 | <input type="checkbox"/> 100—MIXED DEAL "JACKPOT" \$1
Condensers, Resistors, Surprises ... \$1 | <input type="checkbox"/> 20—STANDARD TUBULAR
CONDENSERS .047-600v ... \$1 |
| <input type="checkbox"/> only one to a customer ... \$1 | <input type="checkbox"/> 10—ASST DUAL CONTROLS
for Radio, TV, Hi-Fi, Stereo, etc. ... \$1 | | |

BROOKS RADIO & TV CORP., 84 Vesey St., Dept. A, New York 7, N.Y. TELEPHONE
Cortlandt 7-2359

Circle 130 on reader's service card

Let these experts answer your questions on **COLOR TV** servicing

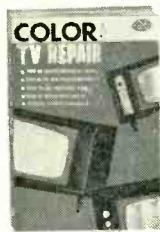

Color TV Repair

10 servicing experts who write for Radio-Electronics magazine reveal tested techniques, practical ideas, tricks-of-the-trade. Shows how to pinpoint defective color section fast, describes trouble-shooting with a color bar generator, outlines causes of TV failure. Includes servicing of chroma circuits, etc. 160 pages, paperback.

Order #123\$2.95

Servicing Color TV

by Robert G. Middleton. A practical book that shows how to service color TV sets and make money doing it. Includes facts on signal tracing, test equipment, color sync servicing, chroma circuit servicing, matrix testing, etc. 224 pages, paperback.

Order #65\$2.90

TV Sweep Oscillators

by Harry E. Thomas. A practical, non-mathematical handbook that explains relaxation oscillators, pulse techniques, transistorized oscillators, sawtooth generators, synchronization, failure analysis, sweep oscillator servicing, etc. 226 pages, paperback.

Order #119 (at parts jobbers only)\$3.95

Horizontal Sweep Servicing Handbook

by Jack Darr. Gives you fast, simple methods of locating and repairing troubles in the sweep system. Practical shortcuts, developed on the bench for rapid isolation of trouble. Includes horizontal oscillator, multivibrator, output stage, etc. 224 pages, paperback.

Order #115\$4.10

Order from your Electronic Parts Distributor today, or mail to:
Gernsback Library, Inc., Dept. RE-166,
154 West 14 Street, New York, N. Y. 10011

Send the following books:

- #123 (\$2.95)
- #65 (\$2.90)
- #115 (\$4.10)

I enclose \$..... (prices 10% higher in Canada)

Name
Address
City..... State..... Zip.....
My distributor is

NOTEWORTHY CIRCUITS

AMPLIFIER BIAS CIRCUIT

Distortion caused by clipping is often the result of poor bias regulation in the audio power output stage. In a stage with cathode bias, increased grid drive increases the cathode current. The drop across the cathode resistor shifts the bias point away from its optimum value. This bias shift decreases the maximum plate swing and causes flat-topping.

One way to eliminate this problem is to replace the cathode resistor with a Zener diode whose voltage rating equals the specified cathode bias voltage and whose wattage rating is at least 50% higher than the product of the bias voltage and the peak cathode current. A Zener diode used for cathode bias in a high-power output stage is rather expensive.

In an article in *Hi-Fi News* (Croydon, England), Reginald Williamson describes a unique method of using a Zener diode indirectly to regulate the bias of a power amplifier stage. The circuit, for which a patent has been applied for, is shown in the diagram.

With the original cathode-resistor biasing, the amplifier's sine-wave power output was 20 watts, with the clipping point somewhat higher. Using the biasing network shown, the continuous power rating is substantially higher and clipping does not occur below 48 watts output.

Here is how the circuit works: Instead of using an expensive Zener diode rated at 10 watts or higher, the inventor uses a small (1-watt) Zener diode to regulate the base bias of an inexpensive power transistor. The transistor is operated in a common-collector mode with nearly 100% negative feedback, and the emitter and base voltages are essentially equal. Thus, we have a low-power Zener diode regu-

lating cathode bias by regulating the transistor's base voltage.

The transistor can be almost any p-n-p power transistor whose V_{CB} and I_C ratings are at least 50% greater than the cathode bias voltage and peak cathode current. In this circuit, the transistor's dynamic impedance is very low so cathode bias remains constant regardless of variations in cathode current. The bypass capacitor protects the transistor against abnormal voltage surges that may appear between emitter and collector.

The transistor dissipates a lot of heat, so mount it in a cool spot on the chassis and use a silicone grease for good heat conductivity. END

ECLL800/6KH8 TUBES AVAILABLE

We still get inquiries from readers interested in building the 20-watt, 3-tube stereo power amplifier described in the November 1963 issue of *RADIO-ELECTRONICS*. The unique German-made ECLL800 twin-pentode-plus-triode output tubes are still available from Allied Radio Corp., 100 No. Western Ave., Chicago, Ill. 60680, but with a different stock number from that given in the May 1964 issue.

The new ordering information is: type ECLL800, stock No. 39 J 278, price \$4.95 apiece.

The output tubes will run somewhat cooler, with no appreciable change in performance, if R19 is increased to 120 or 130 ohms, 10 watts. Also, a smaller, less expensive and lighter power transformer can be used—520 volts ct at 90 ma (Allied stock no. 61 U 412). In that case, increase R20 to 30,000 or 33,000 ohms, 10 watts. END

Zener-plus-transistor bias clamping circuit. Note that collector is at chassis potential—no insulation required.

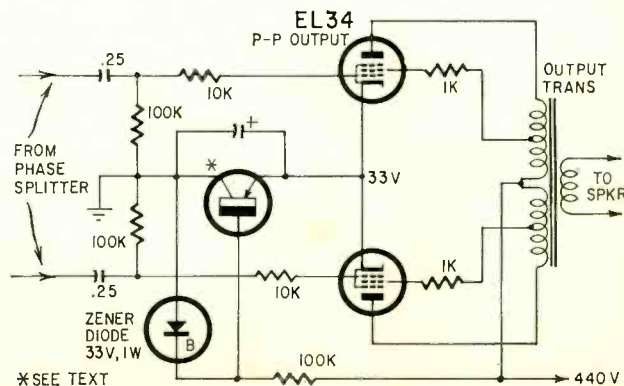

*SEE TEXT

3 → MAR P16
5 → JUNE P14

WHAT'S YOUR EQ?

These are the answers. Puzzles are on page 58.

How Many Relays?

Four relays can be controlled, as shown in the diagram. If only S1 is operated, pulsating dc is put on the line. The polarity is such that current passes through the rectifier to RY1, but is blocked from RY2 by its rectifier. The cable shield serves as return for all control circuits.

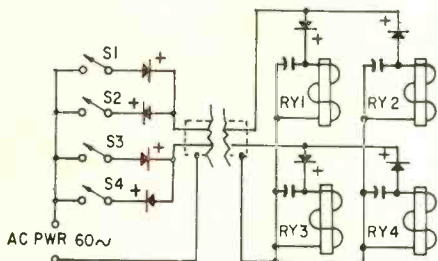

If only S2 is closed, pulsating dc of the opposite polarity is put on the line, passing through the rectifier to RY2, but blocked from RY1. If both S1 and S2 are operated, ac is put on the line, operating both RY1 and RY2.

The same sequence holds for S3-RY3, and S4-RY4. The capacitors connected across the relay coils eliminate chatter.

Glow-Lamp Memory Circuit

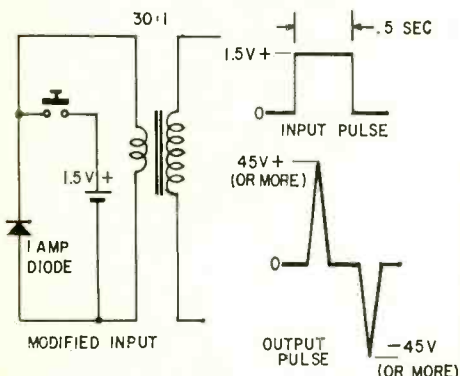

Assume NE1 is conducting and potential at point A is +60 volts—the maintaining voltage of NE1. When S1 is pressed, the transformer produces an

output pulse of +45 volts (or more). This causes the circuit to flip. The pulse passes through NE1, raising the potential of A to a peak that fires NE2. As the output-pulse voltage falls toward zero, N1 is extinguished and N2 remains conducting.

When S1 is released, a negative output pulse of -45 volts (or more) is induced in the transformer secondary. This causes the circuit to flop by firing NE1. As a result, A is clamped at +60 volts and NE2 is extinguished.

If NE2 is initially conducting, the positive output pulse does not switch NE1 into steady conduction. However, the succeeding negative output pulse causes NE1 to flop into conduction and, as a result, NE2 is extinguished.

A positive pulse of sufficient duration (produced by S1) always flops NE1 into steady conduction. Conversely, a negative S2 pulse of sufficient duration always flops NE2 into steady conduction.

Note: An approximation of the output waveform can be obtained by modifying the input circuit (one polarity) as shown in the diagram. Otherwise, when the button is released, the output-pulse amplitude is much greater than when the button is pressed. This is caused by the higher speed of field collapse in the transformer as compared to build-up. The diode simulates a low-impedance zero source when button is released.

END

Olson

FREE

Fill in coupon for a FREE One Year Subscription to **OLSON ELECTRONICS'** Fantastic Value Packed Catalog—Unheard of **LOW, LOW PRICES** on Brand Name Speakers, Changers, Tubes, Stereo Amps, Tuners, CB, Hi-Fi's, and thousands of other Electronic Values. Credit plan available.

NAME _____
ADDRESS _____
CITY _____ ZONE _____ STATE _____

If you have a friend interested in electronics send his name and address for a FREE subscription also.

OLSON ELECTRONICS, INC.

442 S. Forge Street, Akron, Ohio 48430

Circle 131 on reader's service card

Please include your ZIP code No. when renewing your Radio-Electronics subscription.

ELECTRONICS

Engineering-Technicians

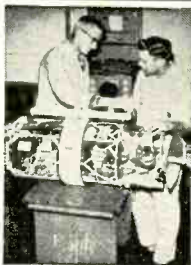

The Nation's increased demand for Engineers,

Electronic Technicians, Radio TV Technicians is at an all time high. Heald Graduates are in demand for Preferred High Paying Salaries. Train now for a lucrative satisfying lifetime career.

Bachelor of Science Degree, 30 Months
Save Two Years' Time

- Radio-Television Plus Color Technician (12 Months)
- Electronics Engineering Technology (15 Months)
- Electronics Engineering (B.S. Degree)
 - Electrical Engineering (B.S. Degree)
 - Mechanical Engineering (B.S. Degree)
 - Civil Engineering (B.S. Degree)
 - Architecture (B.S. Degree)

Approved for Veterans

DAY AND EVENING CLASSES

Write for Catalog and Registration Application. New Term Starting Soon.

HEALD'S

ENGINEERING COLLEGE

Est. 1863—103 Years
Van Ness at Post, RE
San Francisco, Calif.

Your Name _____
Address _____
City _____
State _____

Circle 132 on reader's service card

HOW TO BE A GO-GO SOUND MAN

There's spare-time cash for you in discothèque sound systems! Read how to set up a system—find out what you need, how to charge for your services, what precautions to take, plus pointers from an author who's learned by experience!

Coming in February
RADIO-ELECTRONICS

SCHOOL DIRECTORY

LEARN

ELECTRONICS

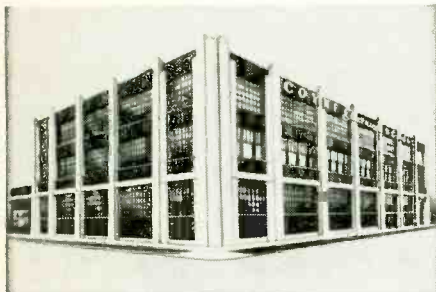

FOUNDED 1899

NOT-FOR-PROFIT

COYNE ELECTRONICS INSTITUTE

Electronics Engineering Technology	—	Degree (2 Yrs.)
Electrical-Electronics Technician	—	Diploma (40 Wks.)
TV-Radio-Electronics Technician	—	Diploma (40 Wks.)
Combined Electronics Technician	—	Diploma (80 Wks.)
Practical Electrical Maintenance	—	Diploma (32 Wks.)
Practical Refrigeration Air Conditioning and Appliance Repair	—	Diploma (24 Wks.)
Specialized Industrial Electronics	—	Diploma (16 Wks.)
Introduction to Electricity-Electronics	—	Certificate (8 Wks.)
FCC First Class Radiotelephone	—	Certificate (100 Hrs.)

Special finance plans. Part time employment service while in school. Also Free graduate employment service.



Use this coupon to get our FREE BOOK "YOUR OPPORTUNITIES IN ELECTRONICS"

COYNE ELECTRONICS INSTITUTE, Dept. of Electronics 16-N
1501 W. Congress Parkway, Chicago, Illinois 60607

Name _____ Age _____

Address _____ Phone _____

City _____ Zone _____ State _____

Unlike most other schools, we do not employ salesmen

Circle 133 on reader's service card

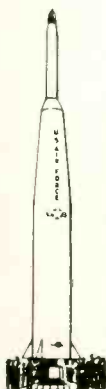

Learn Electronics for your SPACE-AGE EDUCATION at the center of America's aerospace industry

No matter what your aerospace goal, you can get your training at Northrop Tech, in sunny Southern California.

COLLEGE OF ENGINEERING. Get your B.S. degree in engineering in just 36 months by attending classes year round. Most Northrop Tech graduates have a job waiting for them the day they're graduated!

A & P SCHOOL. Practical experience on real aircraft. One-year course prepares you for F. A. A. A & P certificate. WRITE TODAY FOR CATALOG.

NORTHROP INSTITUTE OF TECHNOLOGY
1199 W. Arbor Vitae, Inglewood, Calif.

ENGINEERING DEGREES



Associate—Bachelor
Also Associate in LIBERAL ARTS earned by

HOME STUDY

Resident Classes Also Available if Desired
Specify course preferred

PACIFIC INTERNATIONAL COLLEGE OF ARTS & SCIENCES

Primarily a correspondence school
Chartered 1935
5507M Santa Monica Blvd. Hollywood, Calif.. 90038

GET INTO ELECTRONICS

V.T.I. training leads to success as technicians, field engineers, specialists in communications, guided missiles, computers, radar and automation. Basic & advanced courses in theory & laboratory. Electronic Engineering Technology and Electronic Technology curricula both available. Assoc. degree in 29 mos. B.S. also obtainable. G.I. approved. Graduates in all branches of electronics with major companies. Start Feb., Sept., Dec., campus. High school graduate or equivalent. Catalog.

VALPARAISO TECHNICAL INSTITUTE
Department C, Valparaiso, Indiana



Get Your First Class Commercial

F.C.C. LICENSE

and earn your

A.S.E.E. DEGREE

Move up. Increase your salary and prestige. How? By acquiring the knowledge and skill that industry needs and pays for!

The unique A.S.E.E. degree program available at Grantham School of Electronics teaches you what industry wants you to know for advanced employment. And you can complete three-fourths of this program while at home on your present job. Only one semester must be completed in residence.

Get the facts from our free catalog. Then, with our assistance, get the knowledge. Your F.C.C. license, your A.S.E.E. degree, and higher-paid employment follow naturally. Ask for *catalog 64*.

Grantham School of Electronics

1505 N. Western Ave., Hollywood, Cal. 90027
(Phone: HO 9-7878)

408 Marion Street, Seattle, Wash. 98104
(Phone: MA 2-7227)

818-18th St., NW, Washington, D.C. 20006
(Phone: 298-7460)

Circle 134 on reader's service card

Thinking of college and a space age career in electronics?

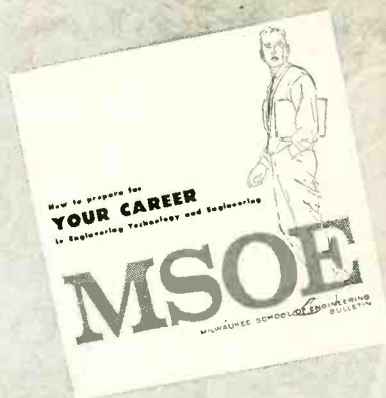

Send for this booklet on ENGINEERING TECHNOLOGY AND ENGINEERING

Learn how you can prepare for a dynamic career as an electrical or mechanical engineering technician or engineer in such exciting, growing fields as avionics, missiles, reliability control, fluid mechanics, data processing, metallurgy, microelectronics, and advanced aerospace research.

MSOE offers residence study programs leading to these degrees in engineering technology and engineering:

2 years—Associate in Applied Science
4 years—Bachelor of Science

Also get facts about scholarships and financial aids, job placement and other student services, plus photographs of MSOE technical laboratories and student activities. For your copy, just mail the coupon — no obligation.

MSOE

Milwaukee School of Engineering
Dept. RE-166, 1025 N. Milwaukee St.,
Milwaukee, Wisconsin 53201

Please send the "Your Career" booklet. I'm interested in
 Electrical fields Mechanical fields

Name.....Age.....

Address.....

City.....State.....ZIP.....

MS-227A

Circle 135 on reader's service card
RADIO-ELECTRONICS

NEW BOOKS

FIELDS AND WAVES IN COMMUNICATION AND ELECTRONICS, by Simon Ramo, John R. Whinnery, Theodore Van Duzer. *John Wiley & Sons, Inc.*, 605 3rd Ave., New York, N. Y. 10016. 6 x 9 1/4 in., 754 pp. Cloth, \$13.50

This engineering text is the successor to *Fields and Waves in Modern Radio*. Complete coverage of the subject, based on Maxwell's equations.

RCA SILICON CONTROLLED RECTIFIER EXPERIMENTER'S MANUAL. *RCA Electronic Components and Devices, Harrison, N.J.* 8 3/8 x 5 3/8 in., 80 pp. Paper, \$0.95.

Contains 14 experimental projects, ranging from lamp dimmer to electronic synchronous switch, as well as two chapters on the theory of the silicon controlled rectifier and a description of equipment. Intended for use with the RCA Experimenter kits, which contain all the components necessary for constructing the projects described, and which sell at \$2.45 to \$9.95 per kit.

THEORY OF ELECTROMAGNETIC WAVE PROPAGATION, by Charles Herach Papos. *McGraw-Hill Book Co.*, 330 W. 42 St., New York, N.Y. 10036. 6 x 9 in., 242 pp. Cloth, \$10

A graduate course for physicists and researchers. Discusses problems in radio astronomy, communications and space exploration.

APPLIED MECHANICS FOR ENGINEERS, by Sir Charles Inglis. *Dover Publications, Inc.*, 180 Varick St., New York, N.Y. 5 1/2 x 8 1/2 in., 404 pp. Paper, \$2

Assumes knowledge of basic statics, dynamics and differential equations. Numerical examples and problems make it especially suitable for self-study. Unaltered republication of 1951 work.

BASIC ELECTRONICS, "AUTOTEXT", A PROGRAMMED COURSE IN CIRCUITS, edited by Jack W. Friedman, Harry G. Rice, Gerald McGinty of RCA Institutes. *Prentice-Hall, Englewood Cliffs, N.J.* 6 x 9 1/4 in., 534 pp. Cloth, \$13

An excellent text for the beginner in electronics, especially for the one who has to study by himself. An answer sheet is removed from the back of the book and laid down in sight as each lesson is studied. The lessons consist of a series of statements and question. The student's understanding of each paragraph is verified before he goes on to the next. This puts him almost in the position of a student working with an instructor.

ELECTRONIC COMPONENTS HOBBY MANUAL. *General Electric, Owensboro, Ky.* 5 1/2 x 8 1/2 in., 199 pp. Paper, \$1.50

Beginning with a 40-page introduction on operation of components, the book continues with 35 projects (automobile, entertainment, home, workshop). The projects are especially slanted toward the GE-X series of experimenter electronic compo-

nents, and can readily be constructed with equipment purchasable in any good electronic supply house.

CRC HANDBOOK OF CHEMISTRY AND PHYSICS, 46th Edition, edited by Robert C. Weast, Ph.D., Samuel M. Selby, Ph.D. *Chemical Rubber Co.*, 2370 Superior Ave., Cleveland, Ohio 44114. 7 1/2 x 10 1/2 in., 1,700 pp. Cloth, \$16

The 46th edition carries on the 7 1/2 x 10 1/2-in. format introduced with the 45th edition. It has been increased by 200 pages, to a total of over 1,700 pages, and contains nearly 450 tables, including a number made useful by the very latest discoveries in physics and chemistry. The mathematics section has been revised, with many tables set vertically rather than horizontally, and the table of integrals is enlarged.

BRITISH MINIATURE ELECTRONIC COMPONENTS DATA, 1965-66, edited by G. W. A. Dummer and J. Mackenzie Robertson. *Pergamon Press*, 44-01 21 St., Long Island City, N. Y. 11101. 8 1/2 x 11 1/2 in., 984 pp. Cloth, \$28

Covers newer British miniature components, from accelerometers to wires and cables, in 984 large pages. More than 90% of the items listed in this fourth edition are new—readers are referred to the 1963-64 edition for components covered previously.

END

ADDITIONS TO SIGNAL-MAKERS DIRECTORY

Information and specifications on the Precise line of signal generators listed below did not arrive in time to be included in the directory in the November Issue. Perhaps you would like to clip this page and file it in your November Issue.

Model 610 rf signal generator tunes from 300 kc to 110 mc in five fundamental ranges and 60-220 and 90-330 mc on calibrated harmonics. Colpitts oscillator can be modulated by external source or 60- and 400-cycle internal circuits.

Model 610K kit, 610KA kit with prewired and tuned rf head, 610W wired. 8 1/2 x 12 x 5 in., 11 lb (shpg wt).

Model 630 (RF-AF-TV Marker and Bar Generator) uses Colpitts rf oscillator to cover from 300 kc to 110 mc on five fundamental ranges; 60 to 220 and 90 to 330 mc on calibrated harmonics. A Wien-bridge audio oscillator tunes from 20 to 20,000 cycles, providing sine-wave audio for audio tests and a source of modulating signal for the rf oscillator. Both oscillators can be used separately or in combination, with modulation variable to any desired level at any audio frequency. The modulated rf signal produces bars for vertical and horizontal linearity adjustments when tuned to a TV channel. Features include cathode follower output, rf step attenuator, constant output impedance and external modulation.

Model 630K kit, 630KA kit with prewired and tuned rf head, 630W wired. 8 1/2 x 12 x 5 1/2 in., 11 lb (shpg wt).

Model 635 (AF Sine, Square and Pulse Generator)—one of the latest additions to the Precise line—uses a 5-tube circuit with a Wien-bridge oscillator and 3-stage clipper to produce square waves and pulses to 50 kc with little or no distortion. Sine-wave output from 20 cycles to 200 kc in 5 ranges. Features two cathode-follower outputs with variable output impedance, full-wave transformer power supply, heavy filtering and 1% resistors in frequency-determining circuit.

Model 635K kit, 635W wired. 8 1/2 x 12 x 5 1/2 in., 11 lb (shpg wt).—*Precise Electronics and Development, Div. of Designatronics, Inc.*, 76 E. 2d St., Mineola, N.Y. END

start your career here

Tri-State graduates hold important engineering and business administration posts throughout the U. S. Tri-State is a small professionally-oriented college in the beautiful lake section of NE Indiana. Excellent faculty, well-equipped labs, new library and residence halls, 300-acre campus, small classes, rich tradition. Modest costs. Four-quarter year permits degree in three years. One-year Drafting-Design Certificate program. For Catalog, write Director Admissions indicating career interest. Graduate placement outstanding!



TRI-STATE COLLEGE

2416 College Avenue, Angola, Indiana

EARN Electronics Engineering DEGREE

You can earn an A.S.E.E. degree at home. College level HOME STUDY courses taught so you can understand them. Continue your education, earn more in the highly paid electronics industry. Missiles, computers, transistors, automation, complete electronics. Over 27,000 graduates now employed. Resident school available at our Chicago campus—Founded 1934. Send for free catalog.

American Institute of Engineering & Technology
1139 West Fullerton Parkway, Chicago 14, Ill.

A JOB or a POSITION?

The difference is **ELECTRONIC MATHEMATICS**

NOW! A NEW WAY TO LEARN—I. H. S. I. WAY! A complete home study course in electronic math to help you get the position you want—**MORE MONEY—MORE RESPECT.**

COURSE PREPARED BY COLLEGE PROFESSORS who have lectured to thousands of men on math and engineering. You learn at home quickly, easily—**AS FAST** as you want.

YOU SIGN NO CONTRACTS Pay only if satisfied—you owe it to yourself to examine the **INDIANA HOME STUDY INSTITUTE COURSE IN ELECTRONIC MATH. FREE BONUS**—If you join now, a refresher course in basic arithmetic.

Write for Brochure—No Obligation

THE INDIANA HOME STUDY INSTITUTE
Dept. RE-1, P.O. Box 1189
Panama City, Fla. 32402

SILICON RECTIFIER SALE

IMMEDIATE DELIVERY

FULLY GTD AMERICAN MADE  NEWEST TYPE FULLY TESTED

750 MA-SILICON "TOPHAT" DIODES
LOW LEAKAGE FULL LEAD LENGTH

PIV/RMS	PIV/RMS	PIV/RMS	PIV/RMS
50/35	100/70	200/140	300/210
.05 ea.	.07 ea.	.10 ea.	.12 ea.
400/280	500/350	600/420	700/490
.14 ea.	.19 ea.	.23 ea.	.27 ea.
PIV/RMS	PIV/RMS	PIV/RMS	PIV/RMS
800/560	900/630	1000/700	1100/770
.35 ea.	.45 ea.	.60 ea.	.75 ea.

ALL TESTS AC & DC & FWD & LOAD

SILICON POWER DIODE STUDS					
D.C. AMPS	50 PIV 35 RMS	100 PIV 70 RMS	150 PIV 105 RMS	200 PIV 140 RMS	300 PIV 210 RMS
1/2	.25 ea.	.12 ea.	.16 ea.	.22 ea.	.27 ea.
1	.50	.25	.32	.44	.55
2	1.00	.50	.64	.88	1.10
5	2.50	1.25	1.60	2.20	2.75
10	5.00	2.50	3.20	4.40	5.50
20	10.00	5.00	6.40	8.80	11.00
50	25.00	12.50	16.00	22.00	27.50
100	50.00	25.00	32.00	44.00	55.00

"SCR" SILICON CONTROLLED RECTIFIERS "SCR"							
PRV	7 AMP	16 AMP	25 AMP	PRV	7 AMP	16 AMP	25 AMP
25	.30	.50	.85	250	1.75	2.15	2.50
50	.60	1.00	1.70	500	3.50	4.30	5.00
100	1.20	2.00	3.40	1000	7.00	8.60	10.00
150	1.80	3.00	5.10	1500	10.50	12.90	15.00
200	2.40	4.00	6.80	2000	14.00	17.40	20.00

SPECIALS! SPECIALS!

100 Different Precision Resistors
1/2-1-2 watt 1/2%-1% TOL \$1.50
2 amp 1000 Piv Silicon Power Rect. .70 ea.
10 for \$6.50

R.C.A. P.N.P. TRANSISTOR
Type 2N406 4 for \$1.00, 100 for \$18.
FACTORY NEW

Computer Grade Condenser 15,500 MFD
15 VDC American Mfg. .75 ea.
Type IN34 DIODE GLASS .07 ea 100 for \$5
Money Back guarantee. \$2.00 min. order. Orders F.O.B. NYC. Include check or money order. Shpg. charges plus. C.O.D. orders 25% down.

Warren Electronic Components
230 Mercer St., N. Y., N. Y. 10012 • OR 3-2620

Circle 136 on reader's service card

MARKET CENTER

DISTRIBUTOR WANTED

No competition. To service and set up new accounts in exclusive territory. Investment secured by fast moving inventory of amazing plastic coating used on all types of surfaces interior or exterior. Eliminates waxing when applied to any type of floor. Eliminates all painting when applied to wood, metal or concrete surfaces.

Minimum Investment—\$500
Maximum Investment—\$12,000

For details write or call:
Phone: 314 AX-1-1500
MERCHANDISING DIVISION
P. O. BOX 66
ST. ANN, MISSOURI 63074

GENERAL

TV SERVICE ORDER BOOKS for use with your rubber stamp. Duplicate or triplicate. Low cost. Write for FREE 32 PAGE CATALOG and Special Rubber Stamp Offer. **OELRICH PUBLICATIONS**, 6556 W. Higgins, Chicago, Ill. 60656.

SAFEGUARD PRIVACY! New instrument detects electronic "bugs", wire-tapping and snooping devices. Free information. **DEE EQUIPMENT**, Box 7263-E8, Houston 8, Texas.

CONVERT ANY TELEVISION to sensitive Big-Screen Oscilloscope. Only minor changes required. No electronic experience necessary. Illustrated plans \$2.00. **RELCO-A25**, Box 10563, Houston 18, Texas.

FREE Wine Recipes and Home Brewing Supplies Catalog **COUNTRY WINEMAKER**, Box 243RE, Lexington, Massachusetts.

ALNICO-CERAMIC-FLEXIBLE-ASSEMBLIES. What you need, we have. **MARYLAND MAGNET**, 5412G Gist, Baltimore, Maryland 21215.

ADD, SUBTRACT, MULTIPLY, DIVIDE with switches and diodes. Instructions and theory \$1.95. **FERWALT**, Box 27, Lewiston, Idaho 83501.

MELODY ORGAN, easy to build. Demonstration record \$1. Construction Manual \$3. Free folder. **SOLOTRON COMPANY**, 29641 Gilchrist, Farmington, Mich.

ENGRAVED BADGE—call letters or name \$1.49 —both \$1.89, engraved key chain—deduct \$.60. **ARNAT**, 1864 Jerome, Bronx, New York 10453.

FIBERGLASS boats you make yourself with fabulous new kits. 40 pound dinghy and others. **McNAIR, KITS**, Box 489, Port Washington, N.Y. 11050.

DIAGRAMS—sent airmail—television \$3.00. Radio 1919-1965 \$2.00. Give model. **DIAGRAMS**, Box 55RE, Williamsport, Pa. 17704.

LOSING Hair? Balding? Dandruff? Free copyrighted booklet. **DR. SHIFFER LABORATORIES**, 529 Euclid Arcade, Cleveland, Ohio 44115.

WANTED

QUICK CASH . . . for Electronic EQUIPMENT, COMPONENTS, unused TUBES. Send list now! **BARRY**, 512 Broadway, New York, N. Y. 10012, 212 WALKER 5-7000.

CASH, SONY TRANSISTOR TV's etc. swapped for G-R, H-P, L&N etc. equipment, special tubes, manuals, military electronics. **ENGINEERING ASSOCIATES**, 428 Patterson Road, Dayton, Ohio 45419.

ELECTRICAL EXPERIMENTER, most issues 1913-1920 for cash, optical or electronic equipment or will swap Science and Invention. **E. KAPRELIAN**, 811 Phila. Rd., Joppa, Md. 21085

LABORATORY test equipment. **ELECTRONICRAFT**, P. O. Box 13, Binghamton, N.Y. 13902

SERVICES

METERS—MULTIMETERS REPAIRED and calibrated. **BIGELOW ELECTRONICS**, Box 71-B, Bluffton, Ohio.

TRANSISTORIZED products dealers catalog, \$1. **INTERMARKET**, CPO 1717, Tokyo, Japan.

RONO TUNER SERVICE, P.O. Box 342A, Bloomington, Indiana presents the finest and fastest service in tuner overhauling for **WHOLESALE** prices. VHF \$8.50 UHF \$7.95 UV \$12.50. Includes ALL parts (except tubes), labor and full **ONE YEAR** guarantee. All makes. Returned on **SAME** day.

AUDIO - HI-FI

RENT STEREO TAPES—over 2,500 different—all major labels—free brochure. **STEREO-PARTI**, 1616 Terrace Way, Santa Rosa, Calif.

WRITE for highest discounts on components, recorders, tapes, from franchised distributors. Send for **FREE** monthly specials. **CARSTON**, 1686-R Second Ave. N.Y.C. 10028

HI-FI COMPONENTS, Tape Recorders, at guaranteed "WE will not be undersold" prices. 15-day moneyback guarantee. Two-year warranty. **NO** Catalog. Quotations Free. **HI-FIDELITY CENTER**, 239R East 149th St., N.Y., N.Y. 10451.

TAPE RECORDER SALE. Brand new, latest models, \$10.00 above cost. **ARKAY SALES**, 1028-E Commonwealth Ave., Boston, Mass. 02215.

FREE CATALOG!

148 PAGES • NEARLY 4,000 BARGAINS
OPTICS • SCIENCE • MATH



Completely new 1966 edition. New items, categories, illustrations. 148 easy-to-read pages packed with nearly 4000 unusual items. Dozens of electrical and electromagnetic parts, accessories. Enormous selection of Astronomical Telescopes, Microscopes, Binoculars, Magnifiers, Magnets, Lenses, Prisms. Many war surplus items: for hobbyists, experimenters, workshop, factory. Write for catalog "EH".

CLIP AND MAIL COUPON TODAY

EDMUND SCIENTIFIC CO., Barrington, N. J.
PLEASE SEND ME FREE CATALOG "EH"

Name
Address
City State

BIG CATALOG

World's "BEST BUYS"
in GOVT. SURPLUS
Electronic Equipment

FULL OF TOP QUALITY ITEMS—

Transmitters, Receivers, Power Supplies, Inverters, Microphones, Filters, Meters, Cable, Keys, Phones, Antennas, Chokes, Dynamotors, Blowers, Switches, Test Equipment, Headsets, Amplifiers, etc., etc. **SEND 25¢** (stamps or coin) for **CATALOG** and receive **50¢ CREDIT** on your order. Address Dept. RE.

FAIR RADIO SALES

P.O. Box 1105 • LIMA, OHIO • 45802

CLASSIFIED ADVERTISING ORDER FORM

For complete data concerning classified advertising please refer to box elsewhere in Market Center section.

1	2	3	4	5
6	7	8	9	10
11	12	13	14	15
16	17	18	19	20
21	22	23	24	25
26	27	28	29	30
31	32	33	34	35

No. of Words { @ .30 Non-Commercial Rate } = \$
{ @ .60 Commercial Rate }

Total Enclosed \$

Insert _____ time(s)

Starting with _____ issue

Payment must accompany order unless placed through accredited advertising agency 16

NAME _____

ADDRESS _____

CITY _____ STATE _____ ZIP _____

SIGNATURE _____

MAIL TO: RADIO-ELECTRONICS, CLASSIFIED AD DEPT., 154 WEST 14TH ST., NEW YORK, N.Y. 10011

HI-FIDELITY COMPONENTS. Ham Marine and Communication equipment at considerable savings. If you want to save money write us for our low prices on all your needs. AIREX RADIO CORP., 85 (RE) Cortlandt St., N.Y., N.Y. 10007

STEREO TAPES. Save up to 60% (no membership fees, postpaid anywhere USA). Free 60-page catalog. We discount batteries, recorders, tape accessories. Beware of slogans "not undersold," as the discount information you supply our competitor is usually reported to the factory. SAXITONE, 1776 Columbia Road, Washington, D. C. 20009

EXPERIMENTERS. Stereo-reverberator mechanism—\$7.00 CAL'S Box 2, Dearborn, Michigan

MESHNA CONVERTER KITS convert car radio to short-wave receiver for police and fire. 30-50mc kit \$4.50. 100-200mc kit \$4.50. MESHNA, Lynn, Mass. 01901

BUSINESS AIDS

JUST STARTING IN TV SERVICE? Write for FREE 32 PAGE CATALOG of Service Order books, invoices, job tickets, phone message books, statements and file systems. OELRICH PUBLICATIONS, 6556 W. Higgins, Chicago, Ill. 60656. New Hyde Park 5, N.Y.

1,000 Business Cards, "Raised Letters" \$3.95 postpaid. Samples. ROUTH RE12, 2632 Randleman, Greensboro, N.C. 27406.

HOW COMPUTERS WORK. Send \$2.00 for this easy-to-understand booklet. ELECTRONICS RESEARCH LABORATORY, Box 67, St. Albans Station, New York, N.Y. 11412

BUSINESS OPPORTUNITIES

New scientific transistor instrument detects buried coins, treasures. Will detect gold, silver, copper, iron, etc. \$19.95 up. Free catalog. RELCO A-25, Box 10563, Houston 18, Texas.

EMPLOYMENT OPPORTUNITIES

Technical or Armed services school graduates in electronics are needed to assist in construction and maintenance of research and instructional electronic equipment. Job security and opportunity to further your skills and education. Contact PURDUE UNIVERSITY, Department of Personnel Administration, Bldg. FWA #1, Lafayette, Indiana. An Equal opportunity employer.

ELECTRONICS

BARGAINS in Canadian Electronic equipment and surplus. Send \$1.00 for giant catalogs. ETCO, Dept. R, 520 Fifth Avenue, New York 36, N.Y.

PROFESSIONAL ELECTRONICS PROJECTS — Organs, Timers, Computers, etc.—\$1 up. Catalog 25¢, refundable. PARKS, Box 25565, Seattle, Wash. 98125.

BEFORE You Buy Receiving Tubes, Transistors, Diodes, Electronic Components & Accessories... send for Giant Free Zalytron Current Catalog, featuring all STANDARD BRAND TUBES all Brand New Premium Individually Boxed, One Year Guarantee—all at BIGGEST DISCOUNTS in America! We serve professional servicemen, hobbyists, experimenters, engineers, technicians. WHY PAY MORE? ZALYTRON TUBE CORP., 469R Jericho Turnpike, Mineola, N. Y., 11502

TRANSISTOR IGNITION! Coil, ballast 7.95 Free parts lists. TRANSFIRE Carlisle 20, Mass. 01741



WHY are they talking about me?

Because America is no longer ashamed to talk about me and other children with birth defects. And America is doing something to stop birth defects through March of Dimes treatment and research.

FIGHT BIRTH DEFECTS
Join **MARCH OF DIMES**

NEON AC DC ELECTRIC TESTER FOR HOME AUTO SHOP

Special! 59¢

Special! With every \$10 Order **25¢** per tube (No Limit) from this list.

6AG5 6B6 6SN7
6AU6 6I6 6SA
6AQ5 6K6 6W4

CORNELL

33¢ PER TUBE

100 TUBES OR MORE: **30¢ PER TUBE**

TUBES
1 YR. GUARANTEED

Mutual Conductance Lab-tested, Individually Boxed, Branded and Code Dated Tubes are new, or used and so marked

21 PICTURE TUBES \$13.95 1 Yr. Guar. Aluminized Pay Duct Deposit C.O.D. or Send Dug with Order

12BP6 21AP4 21DP4
12BP6 21AP4 21DP4
12BP6 21AP4 21DP4
12BP6 21AP4 21DP4
12BP6 21AP4 21DP4
12BP6 21AP4 21DP4
12BP6 21AP4 21DP4
12BP6 21AP4 21DP4

all purpose ELECTRONIC CLEANER **79¢** plus shipping

SILICON RECTIFIERS 69¢ PAIR

750 MA 400 P.I.V.

Prestige & Success are yours as an ELECTRONIC EXPERT

FOR CORNELL CUSTOMERS ONLY by special arrangement with the publisher, these amazing bargains are available.

COMPLETE RADIO SERVICING AND BASIC ELECTRONICS COURSE ONLY \$3.00

NEW PRACTICAL TV TRAINING COURSE ONLY \$3.50

Both above courses **\$6.00**

Other tubes at low prices—send for free list

NO SUBSTITUTIONS WITHOUT YOUR PERMISSION

29¢ CHEATER CORDS

MOISE FILTER STOP TV & RADIO NOISES INSTANTLY

plus 10¢ shipping

DIODES / RECTIFIERS 39¢ per pack sensational KIT VALUE!

plus 10¢ shipping

PICTURE EXPANDER 99¢

plus 10¢ shipping

SOLDERING GUN 2.99

plus 10¢ shipping

TEST and REPAIR TV & RADIO SETS APPLIANCES

plus 30¢ shipping

11,000 TUBE SUBSTITUTES \$1.25

ABC TV \$100

Electronic SOLDER

plus 10¢ shipping

CORNELL ELECTRONICS CO.

Dept. RE 1 4217 University Ave., San Diego, Calif. 92105

TERMS: Add 3¢ per tube shipping. Orders under \$5.00 add 3¢ per tube shipping plus 50¢ handling. Canadian orders add approximate

postage. Send 25¢ deposit on C.O.D. orders. No C.O.D. orders under \$5.00 or to Canada. No 24 hr. free offer on personal check orders. 5-DAY MONEY BACK OFFER!

MARKET CENTER

ADVERTISING INDEX

RADIO-ELECTRONICS does not assume responsibility for any errors which may appear in the index below.

Allied Radio Corp. 90-93
 Amperex Electronic Corp. Second Cover
 Brach Manufacturing Corp. (Div. of General Bronze Corp.) 78
 British Industries Corp. (Garrard) 14
 Brooks Radio & TV Corp. 98-99
 Burstein-Applebee Co. 80

Capitol Radio Engineering Institute, The ... 28-31
 Castle TV Tuner Service, Inc. 6
CLASSIFIED 104-107
 Cleveland Institute of Electronics 18-21, 77
 Conar (Div. of National Radio Institute) ... 22
 Cornell Electronics Co. 105

Datak Corporation, The 84
 DeVry Technical Institute 5

Eastman Kodak Company 7
 Electronic Measurement Corp. (EMC) 89

Finney Co. Third Cover

Garrard (British Industries Corp.) 14
 Gernsback Library, Inc. 83, 87, 100

Heald's Engineering College 101
 Heath Company 68-69, 71

IBM Corporation 12
 International Crystal Mfg. Co., Inc. 1, 79
 International Exhibition of Electronic Components 76
 I.E.E.E. 83

Jerrold Electronics Corporation (Distributor Sales Division) 86
 JFD Electronics Corp. 32

Lectrotech Inc. 97

Mercury Electronics Corporation 16

National Radio Institute 8-11, 27

Olson Electronics, Inc. 101

Perma-Power Company 75
 Philco (Techrep Div.) 89

Poly Paks 107
 Precise Electronics & Development (Div. of Designatronics, Inc.) 2

Quam-Nichols Co. 24

Radio Shack 108
 RCA Components & Devices

Test Equipment 23
 Tube Division Fourth Cover

RCA Institutes, Inc. 62-65
 RCA Sales Corporation 15
 Reading Improvement Program 79

Sams & Co., Inc., Howard W. 17, 67
 Sarkes Tarzian, Inc. (Tuner Service Div.) ... 13

Scott, Inc., H. H. 77
 Seco Electronics Corp. 81

Scencore 95
 Sonar Radio Corporation 96
 Sprague Products Company 26

Sylvania (Subsidiary of General Telephone & Electronics) 25

Tarzian, Inc. Sarkes (Tuner Service Div.) ... 13
 Texas Crystals (Div. of Whitehall Electronics Corp.) 81

University Sound (Div. of LTV Ling Altec, Inc.) 78

Warren Electronic Components 103
 Weller Electric Co. 94
 Windsor Electronics, Inc. 96
 Winegard Co. 84
 Wuerth Products Corp. 85

MARKET CENTER 104-107

Chemtronics
 Edmund Scientific Corp.
 Electronic Components Co.
 Fair Radio Sales
 Music Associated
 Penguin Plastics & Paint Corp.
 United Radio Co.

SCHOOL DIRECTORY 102-103

American Institute of Engineering & Technology
 Coyne Electronics Institute
 Grantham School of Electronics
 Indiana Home Study Institute
 Milwaukee School of Engineering
 Northrop College of Science & Engineering
 Pacific International College
 Tri-State College
 Valparaiso Technical Institute

TRANSISTOR ignition kits, components. Free diagrams. **ANDERSON ENGINEERING**, Epsom, N.H. 03239

RADIO & TV TUBES 33¢ each. One year guaranteed. Plus many unusual electronic bargains. Free catalog. **CORNELL**, 4217-E University, San Diego, California 92105

36 PAGE CITIZENS BAND CATALOG. All major brands and accessories. 10¢ Dealer inquiries invited. **KNOX ELECTRONIC**, Dept. RE-2, Gatesburg, Ill. 61401



BLACK/WHITE OR COLOR

THE ONLY SAFE NON-DRIFT TV TUNER CLEANERS

AVAILABLE AT ALL DISTRIBUTORS

CHEMTRONICS

BROOKLYN, N. Y. 11236

SUB CARRIER DETECTOR



Add programs of commercial-free music thru your FM tuner. Detector, self-powered, plugs into multiplex output of tuner or easily wired into discriminator and permits reception of famous background music programs now transmitted as hidden programs on the FM broadcast band from coast to coast. Use with ANY FM tuner.

WIRED UNIT \$75.00
 KIT, with pretuned coils, no alignment necessary \$49.50
 crystal-controlled receivers available

MUSIC ASSOCIATED
 65 Glenwood Road
 Upper Mantclair, New Jersey
 phone 744-3387 area code 201

Rectifiers & Transistors				
SILICON DIODES				
Amps	50 PIV	100 PIV	150 PIV	200 PIV
.75*	.05	.07	.10	.10
3	.08	.14	.16	.22
15	.25	.50	.65	.75
18**	.18	.40	.60	.70
35	.60	.80	1.15	1.30
Amps	300 PIV	400 PIV	500 PIV	600 PIV
.75*	.12	.14	.18	.21
3	.25	.28	.35	.40
15	.90	1.30	1.40	1.65
18**	.85	1.25	1.85	2.50
35	1.90	2.25	2.50	2.90
Amps	700 PIV	800 PIV	900 PIV	1000 PIV
.75*	.25	.32	.40	.55
3	.49	.58	.67	.78
15	1.90	2.30	3.00	3.65
35	3.20	3.55	3.75	4.10

* Top Hat, Epoxy or Flangless ** Press Fit pkg.

1100 PIV, .70 1200 PIV, .85 (.75A TH Epoxy, Flangless) 95¢ ea.
 10 Watt Sil. Zener Stud 12-200 v, 20% 50¢ ea.
 1 Watt Zener diode, axial leads 8-200v, 20% 50¢ ea.
 Sil. diode, 1500 PIV, 50ma, axial leads 35¢ ea.
 Hi-Voltage-Silicon epoxy diode, 2 1/2" x 3/8" x 1/2" \$1.49 ea.
 Hoffman—3000 PIV-200ma \$3.49 ea.
 Hoffman—6000 PIV-200ma \$3.49 ea.
 Thermistor, bead, 900 or 1200 ohms, 600°F, 2/\$1.00
 150 w GER POWER, TO-5

2N456A 70¢, 2N457A 80¢
 2N458A 90¢, 2N511B \$1.50
 2N250 25 watt, 3 amp, 40 volts Germanium 50¢
 2N3075 300 mc, 150 mw, 2 ma, 40 volt Germanium 75¢
 Silicon Power Transistors, 85 w, 2N1724 \$1.50
 Philco Sil., NPN, 2N2479, new 3 for \$1.00
 HF Silicon, 2N702, 100 mc 40¢; 2N703-150 mc 60¢

Light Sensitive Resistor
 75 ohms—10 meg, 100 volts, 150mw \$1.75 ea.

Sil. diodes, 1N200 series, asst'd., new 15 for \$1.00
 Ger. diodes, glass, new, exceeds 1N34 15 for \$1.00
 Nickel-Cadmium Battery, 9 1/2 oz., 8 amp-hr. \$1.95

Varicap-Voltage Variable Capacitor
 27, 47, or 100 pf, 4v, 4:1, new \$1.25 ea.

Silicon Controlled Rectifiers

PRV	.75A	1A	7A	16A	PRV	.75A	1A	7A	16A
25	—	.20	.28	.48	200	.80	.90	1.05	1.70
50	—	.40	.48	.70	300	1.20	1.30	1.60	2.20
100	—	.55	.70	1.20	400	1.70	1.85	2.10	2.70
150	.60	.70	.80	1.50	500	1.95	2.05	3.80	3.30
75A Tophat—1A TO.5—7A & 16A Stud					600	2.30	2.50	3.00	3.90

Money back guarantee. \$2.00 min. order, include postage. Catalog 25¢.

Electronic Components Co.
 Box 2902B Baton Rouge, La. 70821

Circle 137 on reader's service card

CLASSIFIED COMMERCIAL RATE (for firms or individuals offering commercial products or services): 60¢ per word . . . minimum 10 words.
NON-COMMERCIAL RATE (for individuals who want to buy or sell personal items): 30¢ per word . . . no minimum.
 Payment must accompany all ads except those placed by accredited advertising agencies. 10% discount on 12 consecutive insertions, if paid in advance. Misleading or objectionable ads not accepted. Copy for March issue must reach us before January 10th.
WORD COUNT: Include name and address. Name of city (Des Moines) or state (New York) counts as one word each. Zone or Zip Code numbers not counted. (We reserve the right to omit Zip Code if space does not permit.) Count each abbreviation, initial, single figure or group of figures or letters as a word. Symbols or groups such as 8-10, COD, AC, etc., count as one word. Hyphenated words count as two words. Minor over-wordage will be edited to match advance payment.

TUBES. "Oldies", latest. Lists free. STEINMETZ, 7519 Maplewood, Hammond, Indiana, 46324.

FREE Catalog. Electronic parts, tubes. Wholesale. Thousands of items. Unbeatable prices. ARCTURUS ELECTRONICS RE, 502-22 St., Union City, N. J. 07087

McGEE RADIO COMPANY. Big 1966 catalog sent free. America's best values. Hi-Fi-amplifiers-speakers-electronic parts. Send name, address and zip code number to McGEE RADIO COMPANY, 1901 McGee Street, Dept. RE, Kansas City, Missouri 64108

GOVERNMENT SURPLUS Jeeps from—\$52.50, Voltmeters from—\$1.05, Transmitters from—\$6.18, Oscilloscopes, Walkie-Talkies, Multimeters. Typical "As Is" Bid Bargains from Uncle Sam. Tremendous variety. Exciting free list. Write: ENTERPRISES, Box 402-F5, Jamaica, New York 11430.

It's SUPERCALIFRAGILISTICEXPALIDOCIOS. Free: Information on Kit-of-the-Month Club, Catalog of Etched Circuits and Radio Books. Exclusive items. LEADER ENTERPRISES, Box 44718KR, Los Angeles, 90044

CONFIDENTIAL BARGAIN prices electronic parts catalog free. KNAPP CO., 3174 8th Avenue S.W., Largo, Florida

SHELL Model 102 tube and vibrator tester, latest tube chart, money back guarantee. \$9.00, F.O.B. Indianapolis. JOHN KIRBY, 3606 Delmar Road, Indianapolis, Indiana 46220

TV CAMERA KITS, \$16.95 up. Send 10¢ for comprehensive catalog. Box 396R, South Sioux City, Nebraska, 68776

SAVE DOLLARS \$\$\$

on your Radio & TV tubes—special purpose—xmitting the largest stock in the U.S.A.—at the lowest prices that defies all competition.

Write for TV-Radio or special purpose price list. Our motto—lowest prices in the world for only-new unused tubes—United's first quality tubes are 1 yr. guaranteed.

UNITED RADIO CO.

P.O. Box 1000 Newark, N.J.

ZIP

stands for the Post Office Department's new Zoning Improvement Plan. When renewing your RADIO-ELECTRONICS subscription, or sending us a change of address, please let us know what your ZIP Code is. We'll add it to your address mailing plate ...and you'll get speedier delivery



service from the Post Office. By the way, when writing to us, address:

RADIO-ELECTRONICS, 154 West 14 St., New York, N. Y. 10011

EDUCATION/ INSTRUCTION

LEARN ELECTRONIC ORGAN SERVICING. New home study course covering all makes electronic organ including transistors. Experimental kits—schematics—trouble-shooting. Accredited NHSC-GI Approved. Write for free booklet. NILES BRYANT SCHOOL, 3631 Stockton Blvd., Dept. F, Sacramento 20, Calif.

HIGHLY—effective home study review for FCC commercial phone exams. Free literature! COOK'S SCHOOL OF ELECTRONICS, Craigmont, Idaho 83523.

FCC LICENSE in 6 weeks. First Class Radio Telephone. Results Guaranteed. ELKINS RADIO SCHOOL, 2603E Inwood, Dallas, Tex.

SLEEP LEARNING. Hypnotism! Tapes, records, books, equipment. Details, strange catalog FREE. RESEARCH ASSOCIATION, Box 24-RD, Olympia, Wash.

BROADCASTING. Communications Electronics taught quickly—resident classes; correspondence. Free details. Write: Dept. 4, GRANTHAM SCHOOLS, 1505 N. Western, Hollywood, Calif. 90027

Pictorial Study in Amateur Radio. Free Details. D. CROSS, 1212 Lynch, St. Louis, Mo. 63118

COUPON BOOK, Special offers from various firms, to Members of Electronic Experimenters' Club. Dues \$2.00 or write for further particulars. Box 5332-U, Inglewood, Calif. 90310

B.Sc. DEGREE (Engineering) or College Entrance by home study. Send \$1 for 1966 prospectus. CIST, Suite 654, 263 Adelaide St.W., Toronto, Canada.

SPRING DOUBLE BONUS

\$25

FREE WORTH OF

- Transistors
- Rectifiers
- Condensers
- Diodes
- Knobs
- Coils, etc.

Radio, TV Parts. Add 25¢ for handling

—PLUS—

CHOOSE **\$1** ITEM ANY **FREE**

BOTH "GIFTS" FREE WITH \$10.00 ORDERS

FIRST TIME IN U.S.A! "ONE PRICE" SCRS!

Imagine 7-amp, 16-amp and 25-amp at one price! Just check the proper amp and PRV blocks.

7-Amps		16-Amps		25-Amps	
PRV	Sale	PRV	Sale	PRV	Sale
25	.25	150	.75	300	1.50
50	.45	200	1.00	400	1.95
100	.65	250	1.35	500	2.50
				600	2.75

750 MIL TOP HAT AND EPOXIES

PIV	Sale	PIV	Sale	PIV	Sale
50	5¢	600	19¢	1400	95¢
100	7¢	800	24¢	1600	1.10
200	9¢	1000	51¢	1800	1.35
400	13¢	1200	69¢	2000	1.50

SILICON POWER STUD RECTIFIERS

AMPS	25 PIV	50 PIV	100 PIV	200 PIV
3	5¢	7¢	12¢	19¢
15	15¢	22¢	40¢	65¢
35	39¢	50¢	75¢	1.19
AMPS	400 PIV	600 PIV	800 PIV	1000 PIV
3	25¢	35¢	45¢	69¢
15	90¢	1.35	1.59	1.79
35	1.90	2.50	2.75	2.95

- ### FACTORY TESTED SEMI-KON-DUCTORS
- 85 WATT 2N424 PLANAR, silicon, TO-53 npn \$1
 - 30 "KLIP IN" DIODES, made by Sylvania \$1
 - 1 IGNITION SWITCHING TRANSISTORS, 10-AMP \$1
 - 4 2N336 NPN SILICON transistors, Transistor \$1
 - 10 ZENERS REFERENCES stud, asst types \$1
 - 2N998 TYPE, 1000 GAIN, npn silicon, planar .. \$1
 - "MICRO-T" TRANSISTOR, like TMT-1613. \$1
 - 6 TRANSISTOR TRANS'TRS, 2N341, no test, npn \$1
 - 4 "TEXAS" 20 WATTERS, 2N1038-1042, w/sink \$1
 - 4 2N170 TRANSISTORS, by GE, npn for gen'l rf \$1
 - 6 TRANSISTOR RADIO SET, osc-ifs, driver-pp .. \$1
 - 25 GERMANIUM & SILICON DIODES, no test .. \$1
 - 25 TOP HAT RECTIFIERS, silicon, 750ma, no test \$1
 - 10 1000 MC-1N251 GERMANIUM DIODES ... \$1
 - 5 30MC TRANSISTORS, like 2N247, Sylvania .. \$1
 - 3-2N705 MESA, 300 mc, 300 mw, pnp, TO18 .. \$1
 - 1 3N35 TETRODE, 150mc transistor, silicon ... \$1
 - 10 PNP SWITCHING TRANSISTORS, 2N 404, TO5 \$1
 - 10 NPN SWITCHING TRANSISTORS, 2N338, 440 \$1
 - 15 PNP TRANSISTORS, CK722, 2N35, 107 no test \$1
 - 15 NPN TRANSISTORS, 2N35, 170, 440, no test \$1
 - 30 TRANSISTORS, rf,if, audio osc-ifs, TO5 no test \$1
 - 4-2N996 PNP PLANARS, 100MC, TO46 case \$1
 - 4 2N117 TRANSISTORS, nln silicon, TO22 ... \$1
 - 10 FAMOUS CK722 TRANSISTORS, pnp \$1
 - 5 2N107 TRANS'TRS, by GE, pnp, pop, audio pak \$1
 - 2 40W NPN SILICON MESA 2N1048 2N1048 \$1
 - 10 ZENERS GLASS SILICON DIODES, axial, leads \$1
 - 5 SUN BATTERIES TO 1 1/2" sizes, lite sensitive \$1
 - 2 2N718 NPN SILICON PLANARS, by Fairchild .. \$1
 - 4 2N213 TRANSISTORS, mixer-conv, TO22 ... \$1
 - 10 MICRODIODE STABITORS, epoxy, silicon .. \$1
 - 3 2N706 500MW, 300MC NPN PLANAR, TO46 .. \$1
 - 10 30-MC TRANSISTORS, w/shield, TO5, no test \$1
 - 3 2N255 POWER TRANSISTOR EQUALS, TO3 case \$1
 - 2-500MC, 2N708 NPN Silicon planar TO46 .. \$1
 - 3 2N711 300MW. 300 MC, PNP MESA, TO18 .. \$1
 - 15 1AMP 200V epoxy rectifiers, made by Sylvania \$1
 - 25 "EPOXY" SILICON DIODES, untested ... \$1
 - 4 ZENER REFERENCES, 1N429, 6-volt, silicon .. \$1
 - 2 "TINY" 2N1613 2W. 100MC, TO46 case, npn \$1
 - 2 500MC TRANS'TRS, 2N964, mesas, pnp, TO18 \$1
 - 1 85W SILICON PWR TRANSR, npn, like 2N1212 \$1
 - 4 2N43 OUTPUT TRANSISTORS, by GE, pnp, TO5 \$1
 - 4 2N333 NPN SILICON transistors, by GE, TO5 \$1
 - 10 2-6AMP RECT'S, studs, silicon, 50 to 400V .. \$1
 - 6 TRANSISTOR RADIO SET, osc-ifs-driver, p-p .. \$1
 - 3 2-WATT PLANAR TRANS'TRS, 2N697, 100mc \$1
 - 4 2N35 TRANSISTORS, npn, by Sylvania, TO22 .. \$1
 - 4 "MICRO" TRANSISTORS, 2N131's, 1/16", rf \$1
 - 4 CK721 TRANSISTORS, pnp, aluminum case ... \$1
 - 3 2N721 PNP PLANAR, 2W, 75MC, TO-18 ... \$1
 - 3 2N735 NPN MESA, 500MW, 135MC, TO-18 .. \$1

WORLD'S MOST POPULAR \$1 PARTS PAKS

ZENER VOLTAGE REGULATORS 1 watt

3 For \$1

Volts	Volts	Volts	Volts	Volts	Volts	Volts
6.8	10	15	22	33	47	68
7.5	11	16	24	36	51	75
8.2	12	18	27	39	56	82
9.1	13	20	30	43	62	91

10-13 ZENER Stud, choose 3-200V 70¢ ea.

- 10 TUBULAR ELECTROLYTICS, to 500 mf .. \$1
- INFRA-RED PHOTO DETECTOR TRANSDUCER .. \$1
- INFRA-RED PARABOLIC REFLECTOR & FILTER .. \$1
- 40 WORLD'S SMALLEST COND., to .05mf ... \$1
- 4 TRANSISTOR TRANSFORMERS, asst, worth \$25 \$1
- 2 CLAIREX PHOTO ELECTRIC CELL. CL607 ... \$1
- \$25 RELAY SURPRISE, sealed, tiny types \$1
- 3 INFRA-RED DETECTORS, with leads \$1
- \$25 SURPRISE PAK: transistors, rect, diodes, etc \$1
- 40 PRECISION RESISTORS, 1/2, 1, 2W; 1% values \$1
- 30 CORNING "LOW NOISE" resistors, asst. ... \$1
- 60 TUBULAR CONDENSERS, to .5mf, to 1Kv, asst \$1
- 40 DISC CONDENSERS, 27mmf to .05mf to 1KV \$1
- 60 TUBE SOCKETS, receptacles, plugs, audio, etc. \$1
- 30 POWER RESISTORS, 5 to 50W, to 24 Kohms. \$1
- 50 MICA CONDENSERS, to .1mf, silvers too! .. \$1
- 10 VOLUME CONTROLS, to 1 meg, switch too! .. \$1
- 10° ELECTROLYTICS, to 500mf, asst FP & tubular \$1
- 50 RADIO & TV KNOBS, asst, colors & styles .. \$1
- 10 TRANSISTOR ELECTROLYTICS: 10mf to 500mf \$1
- 50 COILS & CHOKES, if, rf, ant, osc, & more .. \$1
- 35 TWO WATTERS, asst incl: A.B., 5% too! ... \$1
- 75 HALF WATTERS, asst incl: A.B., 5% too! .. \$1
- 60 HI-Q RESISTORS, 1/2, 1, 2W, 1% & 5% values \$1
- 10 PHONO PLUG & JACK SETS, tuners, amps .. \$1
- MAGNETIC REED SWITCH, glass sealed \$1
- 30 "YELLOW" MYLAR CONDENSERS, asst val \$1
- 60 CERAMIC CONDENSERS, discs, npo's, to .05 \$1
- 40 "TINY" RESISTORS, 1/10W, 5% too! ... \$1
- 10 TRANSISTOR SOCKETS for pnp-npn transistors \$1
- 30 MOLDED COND'S, mylar, porc, black beauty \$1
- 3 GEIGER COUNTER DETECTOR, tubes, assorted \$1

10¢ FOR OUR "SPRING" BARGAIN CATALOG ON:

Semiconductors Poly Paks Ports

POLY PAKS

TERMS: send check, money order, include postage—avg. wt. per pak 1 lb. Rated, net 30 days. CODs 25%

P.O. BOX 942R
SO. LYNNFIELD, MASS.
"PAK-KING" OF THE WORLD

RADIO SHACK IS NOW SELLING REALISTIC "Lifetime" TUBES TO DEALERS AND SERVICEMEN!



24K GOLD CLAD CONTACTS

• The World's ONLY Lifetime-Guaranteed Tube: a FREE Replacement Whenever It Fails in the Set! • A Premium Tube at a Popular Price! • 24K Gold-Clad Contacts!

Hundreds of dealers and service men specify Realistic Lifetime Tubes because of the obvious PROFIT potential. If you're buying at 50% off list, check these prices—see how much more you'll save by switching to Lifetime Tubes!

Our stores don't compete with you because they sell at "each" prices, substantially more than your cost. Buy 100% GUARANTEED Lifetime Tubes at any Radio Shack, in person or by mail. Nobody but nobody has a deal like Lifetime!

OVER 75 STORES COAST-TO-COAST

- ARIZONA**
Phoenix: 3905 East Thomas Rd.
- CALIFORNIA**
Anaheim: 507 East Katella Ave.
Bakersfield: 1308 19th St.
La Habra: 1511 West Whittier Blvd.
Long Beach: 3976 Atlantic Ave.
Los Angeles:
Downey: Stonewood Shop, Ctr.
Ladera Shopping Center:
5205 Cantelina Ave.
Mission Hills: 10919 Sepulveda Blvd.
Redondo: 19389 Victory at Tampa
Torrance: 22519 Hawthorne Blvd.
West Covina: 2516 East Workman Ave.
West L. A. Pico Blvd. at Overland
Oakland (San Leandro): Boy Fair Shop, Ctr.
Sacramento: 600 Fulton Ave.
San Diego (La Mesa): Grossmont Shop, Ctr.
Santa Ana: Bristol Plaza Shop, Ctr.,
1212 South Bristol
- COLORADO**
Denver: 798 South Santa Fe
- CONNECTICUT**
Middletown: Hamden Mart, Shop, Ctr.
Manchester: Manchester Shop, Parkade
New Haven: 92 York St.
New London: New London Shop, Ctr.
Stamford: 29 High Ridge Rd.
West Hartford: 39 So. Main St.
- ILLINOIS**
Chicago: Evergreen Plaza at 95th St.
- MAINE**
Portland: Pine Tree Shop, Ctr.
- MARYLAND**
Langley Park: Hampshire-Langley Shop, Ctr.
- MASSACHUSETTS**
Boston:
67 Washington St.
594 Washington St.
110 Federal St.
Braintree: South Shore Plaza
Brookline: Westgate Mall
Brookline: 730 Commonwealth Ave.
Cambridge: Fresh Pond Shop, Ctr.
Frammingham: Shoppers' World
Lowell: Central Shop, Plaza
Saugus: N. E. Shop, Ctr.
Springfield: 1182 Main St.
West Springfield: Century Shop, Ctr.
Worcester: Lincoln Plaza
- MINNESOTA**
St. Paul: 473 North Snelling
- MISSOURI**
St. Louis: 1125 Pine St. (Walter Ashe Div.)
- NEW HAMPSHIRE**
Manchester: 1247 Elm St.
- NEW MEXICO**
Albuquerque: 6315 Lomas, N. E.
- NEW YORK**
Binghamton (Vestal): Vestal Shop, Plaza
Buffalo (Clarence): Transitown Shop, Ctr.
New York: 1128 Ave. of the Americas
Schenectady (Roterdaam): Shopping Ctr.
Syracuse: 3057 Erie Blvd. East
- OHIO**
Cincinnati: 852 Swifton Cir.
- OKLAHOMA**
Oklahoma City: Mayfair Shop, Ctr.
Tulsa: 2730 South Harvard
- OREGON**
Portland: 1928 N. E. 42nd St.
- PENNSYLVANIA**
Philadelphia:
2327 G. Catman Ave., Roosevelt Mall
1128 Walnut St.
- RHODE ISLAND**
Cranston: 1301 Reservoir Ave.
East Providence: Shoppers' Town
- TEXAS**
Abilene: 2910 North First St.
Arlington: Collins of Park Row
Brownsville: 847 S. E. Elizabeth St.
Dallas:
1601 Main St.
Medallion Center
125 Wynnewood Village
Fort Worth:
1515 So. University Dr.
900 East Berry St.
3524 East Denton Highway
2615 West 7th St.
Houston:
8458 Gulf Freeway
322 Northline Mall
Belkair: 4759 Bissonnet
San Antonio: 150 Wonderland Shop, Ctr.
Sherman: 1620 Highway 75 North
Waco: 1016 Austin Ave.
- VIRGINIA**
Arlington: Washington-Lee Shop, Ctr.
- WASHINGTON**
Seattle:
2028 Third Ave.
637 N. E. 110th St.

YOU BUY AT UP TO 70% + 10% OFF!

92 TYPES!

60 + 10% OFF
70% OFF
70 + 10% OFF

BUY BIG!

60 + 10% OFF
70% OFF
70 + 10% OFF

SAVE BIG!

60 + 10% OFF
70% OFF
70 + 10% OFF

Type	Sugg. List	3 of Type Or 10 Each	5 of Type Or 25 Each	10 of Type Or 50 Each	Type	Sugg. List	3 of Type Or 10 Each	5 of Type Or 25 Each	10 of Type Or 50 Each	Type	Sugg. List	3 of Type Or 10 Each	5 of Type Or 25 Each	10 of Type Or 50 Each
OZ4	2.55	.92	.77	.69	6BE6	2.20	.79	.66	.59	6W4GT	2.40	.86	.72	.65
1B3/1G3GT	2.90	1.04	.87	.79	6BG6GA	6.50	2.34	1.95	1.75	6W6GT	2.85	1.03	.86	.77
1K3	2.90	1.04	.87	.79	6BK7B	3.40	1.22	1.02	.92	6X4	1.65	.59	.50	.45
1R5	3.05	1.10	.92	.83	6BM8	3.05	1.10	.92	.83	6X8A	3.15	1.13	.95	.85
1U4	2.90	1.04	.87	.79	6BN6	3.20	1.15	.96	.86	12AD6/ 12GA6	2.40	.86	.72	.65
1U5	2.65	.95	.80	.72	6BQ5	2.40	.86	.72	.65	12AT6	1.85	.67	.56	.50
1X2B	3.05	1.10	.92	.83	6BQ6GTB	4.35	1.57	1.31	1.18	12AT7	3.05	1.10	.92	.83
2CY5	3.05	1.10	.92	.83	6BQ7A	3.95	1.42	1.19	1.07	12AU6	2.15	.77	.65	.58
3BZ6	2.30	.83	.69	.62	6BU8	3.35	1.21	1.01	.91	12AU7A	2.45	.88	.74	.67
3CB6	2.25	.81	.68	.61	6BZ6	2.25	.81	.68	.61	12AV6	1.65	.59	.50	.45
3V4	2.50	.90	.75	.68	6BZ7	4.00	1.44	1.20	1.08	12AX4GTB	2.70	.97	.81	.73
5AM8	3.95	1.42	1.19	1.07	6C4	1.85	.67	.56	.50	12AX7A	2.55	.92	.77	.69
5AQ5	2.35	.85	.71	.64	6CB6A	2.25	.81	.68	.61	12BA6	1.65	.59	.50	.45
5AR4	4.50	1.62	1.35	1.21	6CD6GA	5.80	2.09	1.74	1.57	12BE6	1.75	.63	.53	.48
5UA4GB	2.10	.76	.63	.57	6CF6	2.55	.92	.77	.70	12BH7A	3.05	1.10	.92	.83
5U8	3.30	1.19	.99	.90	6CG7	2.45	.89	.74	.67	12BL6	2.65	.95	.80	.72
5Y3GT	1.75	.63	.53	.48	6CG8A	3.30	1.19	.99	.90	12BQ6GTB/ 12CU6	4.45	1.60	1.34	1.21
6AG5	2.75	1.00	.83	.75	6CM7	2.90	1.04	.87	.78	12CY6	3.20	1.15	.96	.86
6AL5	1.85	.67	.56	.50	6CX8	4.20	1.51	1.26	1.14	12BY7A	4.20	1.51	1.26	1.14
6AM8A	3.45	1.25	1.04	.94	6DQ6B	4.15	1.49	1.25	1.13	12DQ6B	4.20	1.51	1.26	1.14
6AN8A	4.00	1.44	1.20	1.08	6EA8	3.20	1.15	.96	.86	12SQ7GT	3.75	1.35	1.13	1.02
6AQ5	2.15	.77	.65	.58	6EB8	4.20	1.51	1.26	1.14	17DQ6B	4.20	1.51	1.26	1.14
6AS5	2.90	1.04	.87	.79	6GH8	3.15	1.13	.95	.85	25L6GT	2.65	.95	.80	.72
6AU4GTA	3.60	1.30	1.08	.97	6J6A	2.85	1.03	.86	.77	35C5	2.15	.77	.65	.58
6AU6A	2.10	.76	.63	.57	6K6GT	2.65	.95	.80	.72	35W4	1.10	.40	.33	.30
6AU8A	4.20	1.51	1.26	1.13	6L6GC	4.35	1.57	1.31	1.18	35Z5GT	1.85	.67	.56	.50
6AV6	1.65	.60	.50	.45	6S4A	2.50	.90	.75	.67	50C5	2.15	.77	.65	.58
6AW8	3.70	1.33	1.11	1.00	6SN7GTB	2.60	.94	.78	.69	50EH5	2.30	.83	.69	.62
6AX4GTB	2.65	.95	.80	.72	6T8A	3.40	1.22	1.02	.92	50L6GT	2.55	.92	.77	.69
6BA6	2.00	.72	.60	.54	6U8A	3.30	1.19	.99	.89	7199	4.70	1.69	1.41	1.27
6BC5/6CE5	2.35	.85	.71	.64	6V6GT	2.20	.79	.66	.59	7591	3.00	1.08	.90	.81

MAIL TODAY OR BUY AT ANY RADIO SHACK STORE

Please send me the following Lifetime tubes:

ADD 50¢ PER ORDER FOR PACKING AND SHIPPING - ANYWHERE IN THE U.S.A.

RE-166

Amount Enclosed \$

Quan.	Tube Type	Quan.	Tube Type	Quan.	Tube Type

Please send FREE 1966 Radio Shack Catalog!

NAME (please print) _____

COMPANY _____

STREET _____

CITY _____

STATE _____

ZIP _____

Circle 140 on reader's service card

FINCO

COLOR-VE-LOG ANTENNAS

FOR UHF, VHF, FM RECEPTION

ALL-BAND UHF-VHF-FM ANTENNA

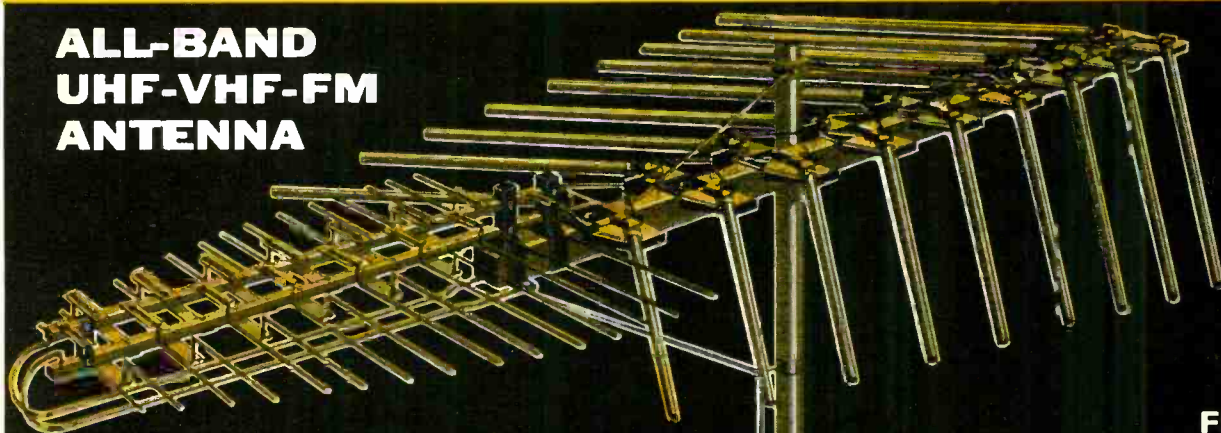

FINCO
Model UVF-24
\$59.95 list

The one antenna that does the work of 3! Gives startlingly clear black and white pictures and beautiful color on both UHF and VHF television channels — plus the finest in stereophonic and monophonic sound reproduction.

FINCO Model UVF-18 — \$42.50 list
FINCO Model UVF-16 — \$30.50 list
FINCO Model UVF-10 — \$18.50 list

SWEPT-ELEMENT VHF-FM ANTENNA

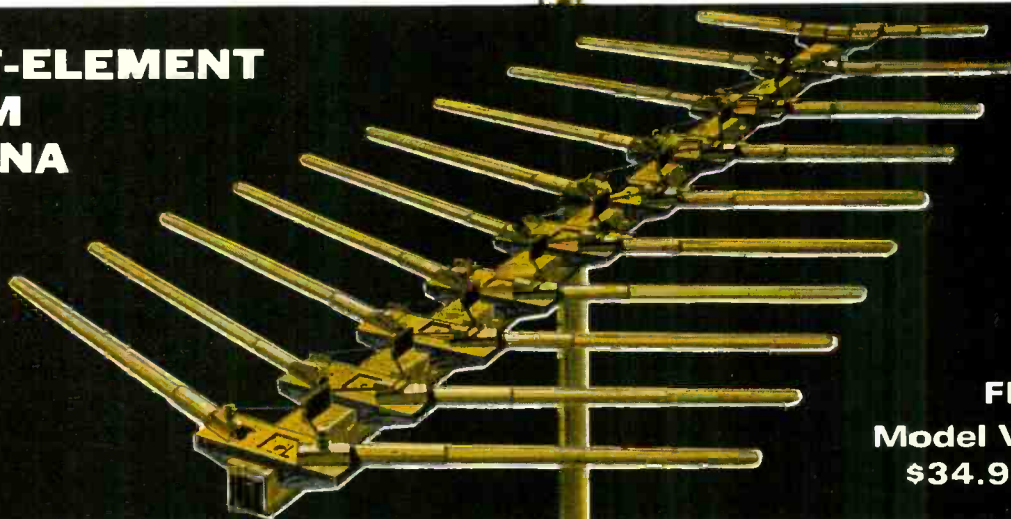

FINCO
Model VL-10
\$34.95 list

FINCO's Color-Ve-Log challenges all competition! Its swept-element design assures the finest in brilliant color and sharply defined black and white television reception — as well as superb FM monaural and stereo quality.

FINCO Model VL-13 — \$54.50 list
FINCO Model VL-15 — \$46.95 list
FINCO Model VL-7 — \$23.95 list
FINCO Model VL-5 — \$16.95 list

Featuring FINCO's exclusive Gold Corodizing

FINCO COLOR-VE-LOG

Prices and specifications subject to change without notice

THE FINNEY COMPANY • 34 W. Interstate Street • Bedford, Ohio

Write for beautiful color brochures Number 20-322, and 20-307, Dept. RE

Circle 141 on reader's service card

RCA all-new, rare-earth Hi-Lite Color Picture Tubes are being stocked by smart dealers who are ready for the replacement color picture tube business.

why?

Hi-Lite's rare-earth phosphors provide picture brightness unsurpassed in the color TV industry. Natural color reproduction. Great black-and-white pictures, too! **RCA's Hi-Lite Color Picture Tube Line is here. Now!** Available in 19-inch and 25-inch rectangulars and 21-inch round tube types.

What about you? Are you ready for color?

RCA ELECTRONIC COMPONENTS AND DEVICES, HARRISON, N.J.



The Most Trusted Name in Electronics

